

## Contents

- Introduction .....1
- What is the DMP LX-Bus?.....1
- LX-Bus™ Specifications.....1
- Distance .....1
- Going Even Farther .....2
- Number of Devices.....2
- LX-Bus Wiring Example.....3
- Zone Expanders .....3
- Output and Annunciator .....3
- Single Point Devices.....4
- Optional Power Supplies .....4
- Resistance to Noise.....4
- LX-Bus Interface Cards.....4

# LX-Bus™ Modules and Applications

## Introduction

When you're deciding on a technology for panel to device communication, you need hard facts presented in a practical, "how to" manner. This Application Note does just that and provides you with the information you need to make an informed decision about a very important topic.

## What is the DMP LX-Bus?

In existence since the early days of the 1912XR Command Processor™ Panel, the LX-Bus is the serial data/power bus that connects DMP 1912XR and XR200 panels to addressable zone, output, and single point detection devices installed throughout a home or business. The LX-Bus is both simple and economical to install or prewire as just a single 22 AWG 4-conductor wire is run from the panel to the devices.

The LX-Bus uses a communication protocol that allows the panel to poll up to one hundred device addresses on a single circuit. The polling is a simple query/response exchange that confirms to the panel the presence of the device on the bus. A device that fails to respond to polling is considered by the panel to be missing and can be reported to the central station and/or displayed on the system's keypads.

Should an alarm occur on an LX-Bus device, the panel quickly processes this information against the zone's programming, armed state of its assigned area, and any other enabled programming options.

## LX-Bus™ Specifications

Three of the most important specifications of panel to device communication bus technologies are: distance, number of devices, and resistance to electrical noise. The LX-Bus offers significant advantages over other technologies in all three of these areas.

## Distance

The maximum *cumulative* distance of one LX-Bus circuit is 2,500 feet. Cumulative is a keyword here because the LX-Bus does not place restrictions on T-tap or branch circuits the way other technologies do. You can run a single 4-wire cable around the perimeter of a building's interior and T-tap at various points to pick up doors, windows, or interior detectors using a variety of addressable expander modules. This capability offers tremendous savings in wire and installation costs.

### LX-Bus™ Expansion

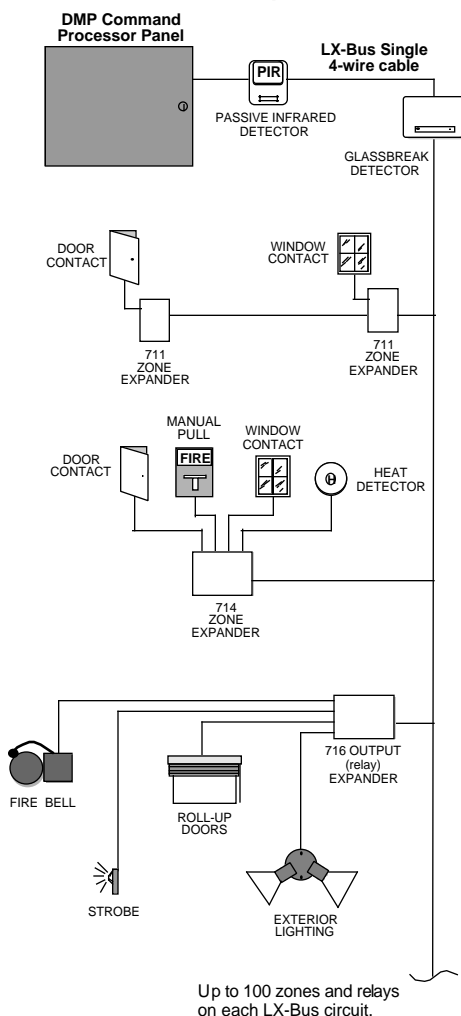

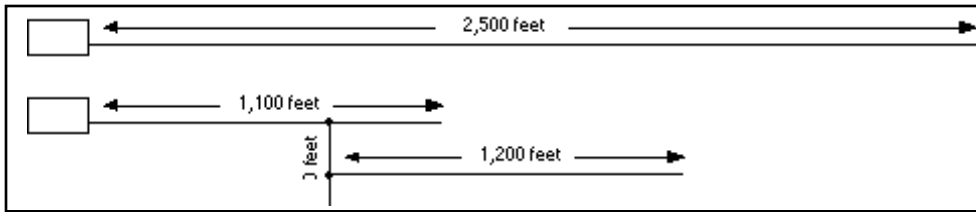

The total wiring distance for any one LX-Bus circuit is 2,500 feet. This distance can be made up of one long run or multiple runs of varying lengths.

## Going even farther

If an installation requires distances greater than 2,500 feet, an inexpensive DMP Model **710 Bus Splitter/Repeater Module** can be added at the far end of the LX-Bus to add an additional 2,500 feet of capability. The 710 module uses advanced circuitry developed by DMP engineers to enhance the data stream between the panel and its addressable devices thus greatly extending the LX-Bus wiring distances.

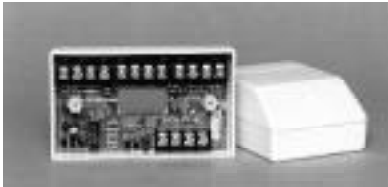

**710 Bus Splitter/Repeater Module**

Each 710 module provides one 4-position terminal strip for connecting the LX-Bus wiring from the panel and one 12-position terminal strip for connecting up to three individual LX-Bus output circuits with a combined wiring distance of 7,500 feet.

You can install multiple 710 modules for a combined LX-Bus wiring distance of **15,000 feet!** This is truly a remarkable distance for data communications on a 12 VDC security/fire panel.

Even if you're not going to exceed the maximum wire length of one LX-Bus circuit, you may still want to use the 710 module as a junction box for connecting multiple LX-Bus wire runs. The 710 provides high quality screw terminal connections for one incoming and three outgoing circuits and allows you to keep the wiring neat and secure.

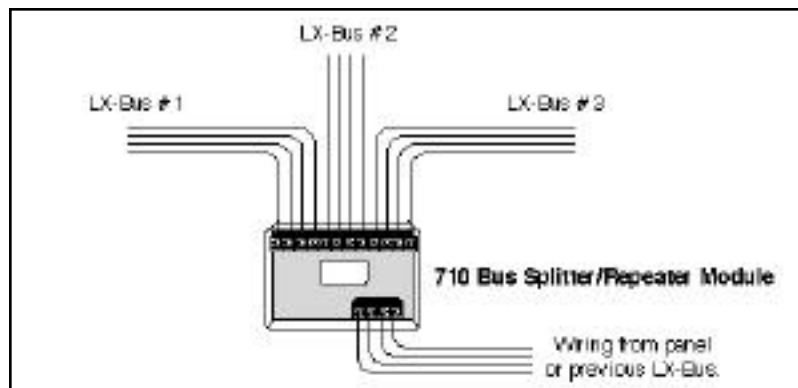

## Number of Devices

The ability of a communications bus to handle multiple expansion devices can be the deciding factor when specifying an alarm panel for large, multi-point installations. Some panels support large numbers of devices but with limited wiring distances while others support long wiring distances with limited numbers of expansion devices.

The LX-Bus leads the way in both fields with the ability to support large numbers of supervised and unsupervised devices over extremely long distances. This ability gives you a decisive advantage in large system installations and provides your customers with superior technology at a competitive price.

You can install up to **40 devices** on one **2,500 foot** LX-Bus circuit or up to **50 devices** on one **2,000 foot** circuit without any restrictions as to where they're placed, whether they're at the end of the circuit, the middle, or spread out along the length of the wire run. This powerful capability gives you great flexibility in designing systems that best meet the needs of your customers.

## LX-Bus Wiring Example

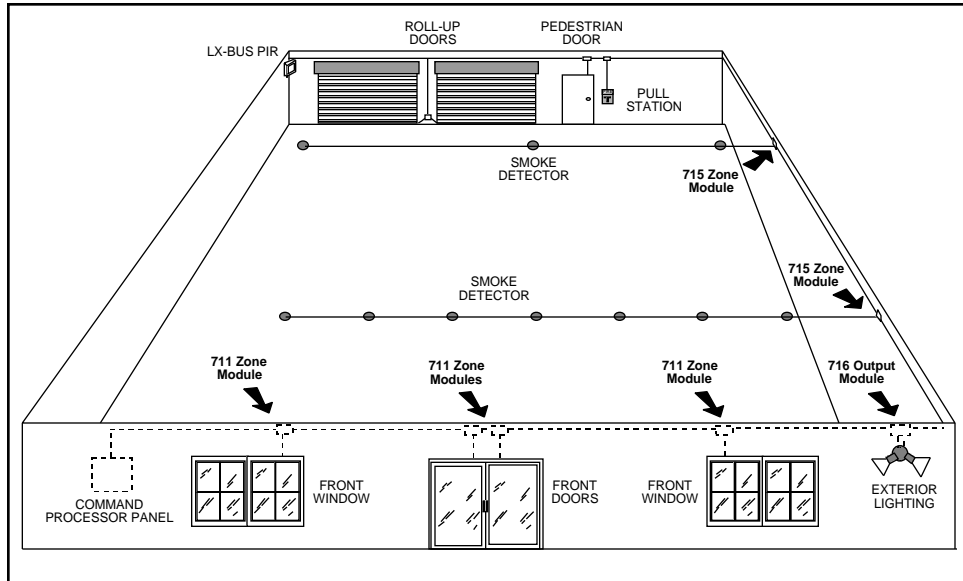

**715 Zone Expander**

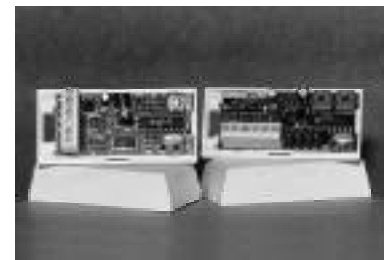

**711 and 711E Zone Expanders**

## Zone Expanders

For zone expansion, you can use either the DMP Model 711 or 711E Zone Expanders with *one* ungrounded, supervised Class B protection zone or the 714 or 715 Zone Expanders with *four* ungrounded, supervised Class B protection zones. The 711, 711E, and 714 Zone Expanders support a wide variety of burglary and non-powered fire devices. The 715 Zone Expander provides *four* 12 VDC ungrounded zones that support a wide variety of burglary and powered or non-powered fire devices such as smoke, heat, and flame detectors.

The 1912XR panel supports one LX-Bus circuit with up to 100 supervised zones available. The XR200 panel supports two LX-Bus circuits with up to 200 supervised zones available.

## Output and Annunciator Modules

When you need relays for activating external devices such as lights, HVAC, or control equipment, the Model 716 Output Expander Module provides four Form C (SPDT) relay outputs that can be programmed to activate in response to a zone alarm, zone trouble, or to system activity such as communication or phone line failure or entry and exit delay times.

The 716 also provides four open collector annunciator outputs. These outputs can be connected to LED, lamp, or piezo annunciators to provide a local indication whenever a zone set to the same address is in an alarm or armed trouble condition. These annunciator outputs are ideal for remote graphic annunciators at guard or nurse stations.

When you need only annunciator outputs, the Model 717 Graphic Annunciator Module provides a full 20 open collector outputs like those found on the 716 module to annunciate the activity of up to 20 zones.

You can install multiple 716 and 717 modules on the LX-Bus to provide a SPDT and/or annunciator output for every zone on the panel, including keypad and panel zones, for full system annunciation.

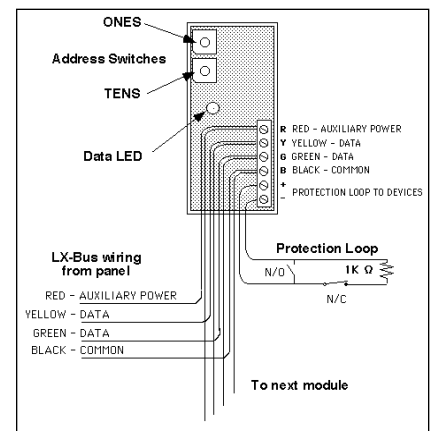

**711 Module Wiring (typical)**



**716 Output Expander**



Detection Systems® DS775LX PIR



Sentrol® ShatterPro™  
5845LX Glassbreak



Sentrol® Sharpshooter™  
6155LX PIR

## Single Point Protection Devices

DMP also offers several high performance PIR and glassbreak detectors from top manufacturers that contain built-in LX-Bus interface modules. These devices allow you to simply connect the wiring, set the address switches, and mount the unit then move on to the next device. Because the LX-Bus technology is built in, there's nothing else to install.

## Using Optional Power Supplies

Although the LX-Bus provides 12 VDC auxiliary power from the panel to the devices, on extremely long wire runs it's sometimes necessary to add an optional power supply. The LX-Bus makes it easy to add a power supply by allowing you to connect it right to the last device on the LX-Bus circuit. You can use any UL listed, regulated 12 VDC power supply.

## Resistance to Electrical Noise

All wiring is subjected to electrical noise when placed in proximity to lights or electrical equipment; things that always seem to be just where your wire needs to go. Good wiring practices can eliminate the majority of electrical noise problems but using a device communication technology that is designed to resist the effects of noise is added insurance against false alarms and missing devices.

The LX-Bus has been engineered to work in less than ideal environments with high speed communication and hardware technology that maintains the integrity of the data being sent between the panel and LX-Bus devices.

## LX-Bus Interface cards

The LX-Bus capability requires either an 881, 862N/P, or 872 Interface Card on the 1912XR or a 481, 462N/P, or 472 Interface Card on an XR200 panel. These cards simply plug into a connector on the panel's circuit board and provide a 4-pin header and 4-wire harness for connecting the LX-Bus wiring.

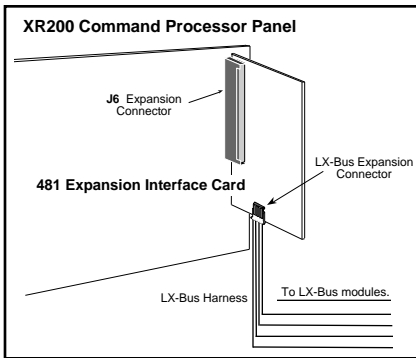

LX-Bus Card connection to  
XR200 panel

## LX-Bus Devices

Model	Description	Operating Current
711	Single zone expander with rotary switch addressing	8mA
711E	Single zone expander with push-button addressing	12mA
714	Four 5 VDC, Class B burglary/fire zones	15mA
715	Four 12 VDC, Class B burglary/fire zones	25mA
716	4 Form C (SPDT) relays and 4 annunciator outputs	11mA
717	20 annunciator outputs	13mA
6155LX	Sentrol® Sharpshooter™ PIR with built-in LX-Bus	15mA
5845LX	Sentrol® ShatterPro™ Glassbreak with built-in LX-Bus	25mA
DS775LX	Detection Systems PIR with built-in LX-Bus	8mA