

# Model SX-3100LCD

## Installation Instructions

---

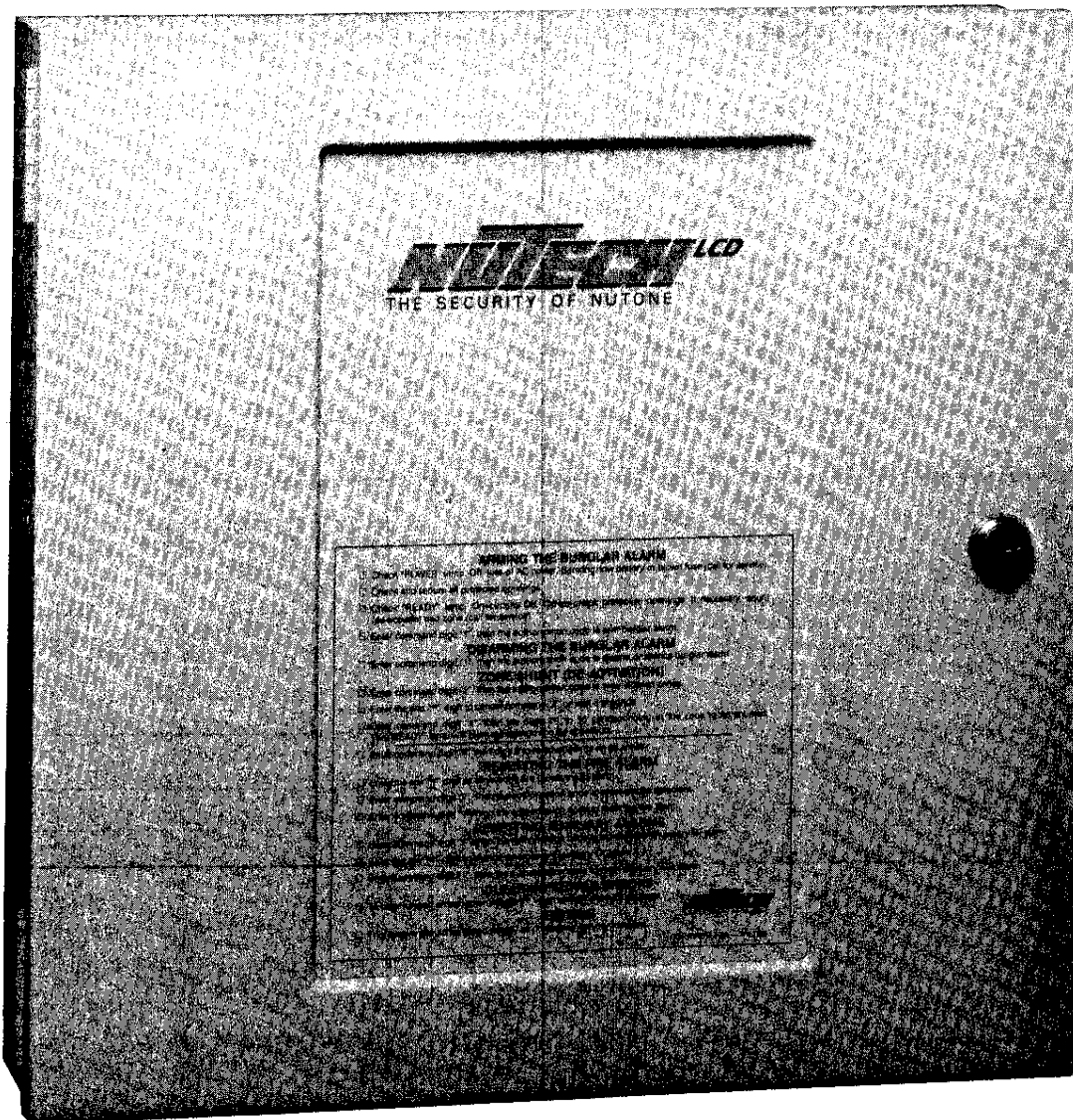

**NUTECH**<sup>TM</sup>  
THE SECURITY OF NUTONE

# INTRODUCTION

Thank you for selecting one of the many fine NuTech products manufactured by NuTone, Inc., an acknowledged leader in home and security electronics. We take pride in our international reputation for product quality and proven performance. This product has been carefully inspected to comply with rigid quality control standards before shipment to you. You'll find that with reasonable care it will provide years of reliable performance.

Proper installation and regular maintenance by the installing company and frequent testing by the user is essential to assure continuous satisfactory operation of any alarm system. It is recommended that the installing company offer a maintenance program and instruct the user with the correct procedure for use and testing of the system.

**COPYRIGHT 1989  
NuTone, Inc.  
Madison and Red Banks Rds.  
Cincinnati, Ohio 45227**

## LIMITED WARRANTY

NuTone Security Products are warranted to be free from defects in material and workmanship for the "Warranty Period" which is eighteen (18) months from the date of original manufacture. Consumable items (such as non-rechargeable batteries or dial lights) are not warranted or guaranteed in any manner for any length of time.

Our warranty does not cover damage or failure caused by Acts of God, abuse, misuse, abnormal usage, faulty installation, improper maintenance or any repairs other than those provided by a NuTone Authorized Security Dealer. **There are no obligations or liabilities on the part of NuTone Inc. or Scovill Inc. for consequential damages arising out of or in connection with the use or performance of the product or other indirect damages with respect to loss of property, revenues or profit, or costs of removal, installation or reinstallation. All implied warranties with respect to NuTone security products, including implied warranties for merchantability and implied warranties for fitness, are limited in duration to eighteen (18) months from date of original manufacture.**

Some states do not allow the exclusion or limitation of incidental or consequential damages and some states do not allow limitations on how long an implied warranty lasts, so the above exclusions or limitations may not apply to you.

During the "Warranty Period," NuTone will repair or replace, at NuTone's sole option, free of charge, any defective parts. Please provide the model number of the product, original date of installation and nature of difficulty being experienced. There will be charges rendered for product repairs made after our "Warranty Period" (as defined above) has expired. This warranty gives you specific legal rights and you may have other rights which vary from state to state.

For NuTone security product service please contact your NuTone Authorized Security Dealer or write: NuTone, 4820 Redbank Road, Cincinnati, Ohio 45227-1599. Attention: Security Products Department.

**ff Special note referencing use of the word "Fire" in this manual.** Use of this control for fire detection and/ or annunciation may not be allowed by certain states, counties, municipalities, or local jurisdiction until such time as the control has been tested and listed by either Underwriters Laboratories, the California State Fire Marshal or an approved testing agency. It is the responsibility of the installing alarm company to check with their local A.H.J (Authority having jurisdiction) or State Fire Marshals' office prior to using this control for fire. The SX-3100LCD is presently undergoing testing and is pending U.L. listing for Household fire alarm use.

**NOT FOR FIRE USE IN THE STATE OF CALIFORNIA.**

# TABLE OF CONTENTS

1. SYSTEM OVERVIEW .....	pg. 2
2. PLANNING THE INSTALLATION .....	pg. 3
3. PARTS DIAGRAM & DESCRIPTIONS .....	pg. 4
4. MOUNTING, WIRING AND TERMINAL DESCRIPTIONS .....	pg. 5
Power Connections .....	pg. 6
Hardwire Zones .....	pg. 7
Control Station Wiring .....	pg. 9
Control Outputs .....	pg. 10
Power Outputs .....	pg. 11
Siren Hookups .....	pg. 12
Telephone Connections .....	pg. 13
Control Board Installation and Layout Diagram .....	pg. 14
Suggested Hookups .....	pg. 16
5. POWER UP AND CONTROL STATION OPERATION .....	pg. 19
Control Station Command Summary .....	pg. 23
6. PROGRAMMING THE CONTROL .....	pg. 25
Program Function Map .....	pg. 27
7. PROGRAMMING FUNCTIONS AND DESCRIPTIONS .....	pg. 31
Restoring the Factory Defaults .....	pg. 31
Configuration Digits .....	pg. 34
Zone Planning Guide .....	pg. 35
8. SPECIAL FEATURES .....	pg. 47
9. SPECIFICATIONS .....	pg. 53
10. FEATURES AND ACCESSORIES .....	pg. 54

# 1. SYSTEM OVERVIEW

The SX-3100LCD Security Control represents the latest technological advancements in the security industry. It is flexible enough to meet or exceed the requirements of most commercial or residential installations. A choice of remote stations is available including the SX-3136, SX-3130, SX-3131, and SX-3132 or the optional new SX-3100ST "Lighted" Security Terminal which has a 48 character Liquid Crystal Display (LCD) alphanumeric readout. The SX-3100LCD can also be controlled with a momentary or shunt type keyswitch. All electronics are contained on a single plug-in circuit board utilizing surface mount "SMD" technology. The many programmable features are easily selected or changed from either the standard remote station or the SX-3100ST Security Terminal. The SX-3100LCD can also be remotely programmed using an IBM PC® or compatible computer, a Hayes® or compatible modem, and the TRANSPORT-PC™ Upload/Download software package. All programming is stored in a non-volatile EEPROM (electrically erasable programmable read only memory), which maintains its data even with power disconnected. The EEPROM allows the control to be reprogrammed up to 10,000 times. A "Watchdog" circuit monitors the microprocessor and assures the operational integrity of the system.

The SX-3100LCD offers many powerful features such as Eight (8) Zone Expansion, Master Arming, Subzoning, Force Arming, Digital Communicator Split reporting, and flexible Extended Reporting for compatibility with most major receivers including popular 4/2. The Z1100e can handle up to seventeen (17) programmable user codes of 1 to 5 digits each. Digits may repeat within each code. Each code is assigned a unique security level. The system also allows the option of 2 digit arming with full code disarm. User authorization code 17 may be defined as a temporary code with a programmed number of usages.

The control is pre-programmed with one 24 hr Auxiliary "A" (fire *ff*) zone, two delay zones, one instant interior zone, four instant perimeter zones, and three control station activated zones (Auxiliary "A", Auxiliary "B", Auxiliary "C"). The system may be used as is or may be programmed to suit specific installation requirements. Separate timers are programmable for alarm cut offs, entrance and exit delays (2 entrance timers), loop response time, and timed access (door strike) output.

The optional SX-3100ST Security Terminal enhances operation by prompting the user (using the LCD screen) through each step in plain English and accepting responses from three selected "Soft Feature" keys. The user interacts with the SX-3100ST in much the same way as most popular 24 Bank Teller Machines. Only the information needed at any specific step is displayed to the user. A Menu scroll key allows access to additional screen choices at the user's desire. Zone descriptions (up to 16 digits) on the LCD can be programmed in BOTH English and some Foreign languages. Adjustable two stage (standby and active) downlight, and full LCD backlight add visibility and sophistication to the SX-3100ST. The second stage (bright active) downlight and LCD backlight will activate on the individual SX-3100ST whenever a key is pressed and automatically time out after 30 seconds of no activity. Each SX-3100ST's downlight and LCD backlight can be selected to light during entry/exit delay, and AC power outages to provide timed courtesy and emergency lighting.

Application	Listing	Maximum Current drain (milliamps) with a 6 Ah Battery	Min. Battery Standby Time in hours	SX-3136 Control Stations	SX-3100ST Control Stations	NuTone Smoke Detector Model S247 or S247H Pyrotector Power Supervision Module Model 20-40-12	Auxiliary Equipment Required
Non U.L. Listed or C.S.F.M Approved		900	3	7	††	N/A	
Household Burglary	U.L. 1023	800	4	6	††	N/A	AMSECO MSB-10G BELL
Household Fire ( <i>ff</i> )	U.L. 985	800	4	6	††	Required	Wheelock 34T-12 Horn
Household Burglary/ Fire ( <i>ff</i> ) Combination	U.L. 1023/ U.L. 985	800	4	6	††	Required	Amseco MSB-10G Bell and Wheelock 34T-12 Horn
Central Station Burglary (Grade C)	U.L. 1610 U.L. 1635	450	4	2	††	N/A	
Central Station Burglary (Grade B)	U.L. 1610 U.L. 1635	450	4	2	††	N/A	TB1100 Tamper Resistant Enclosure and ADEMCO AB-12 Bell & Housing
Local Burglary (Grade A)	U.L. 609	450	4	2	††	N/A	TB1100 Tamper Resistant Enclosure and ADEMCO AB-12 Bell & Housing
Police Station Burglary Connection (Grade A)	U.L. 365	450	4	2	††	N/A	TB1100 Tamper Resistant Enclosure and ADEMCO AB-12 Bell & Housing

Maximum combined Constant current drain (standby) refers to terminals 14, 29, 30, 31, and connector J-15 and J-16. Under Alarm conditions, the combined output current drain should not exceed 1.7 Amps.  
 †† Consult the SX-3100ST instruction booklet.

**TABLE 1 CONFIGURATIONS AND CURRENT DRAIN PROVISIONS**

## 2. PLANNING THE INSTALLATION

The first step in any multi-zone security system installation is planning the job.

1. Read through this entire manual to familiarize yourself with all system features and procedures before actually beginning the installation.
2. Perform a physical survey of the installation site.
3. Discuss the installation requirements and applications with the customer.
4. Compare the installation requirements and applications with the factory default settings (see FUNCTION MAP) to determine what, if any, customized programming will be needed to meet the specific installation requirements.
5. **We recommend that the system be bench tested prior to installation.**

Figure 1 details a typical (fire *ff*) and burglar installation layout. This may be used as a guide in planning the specific installation.

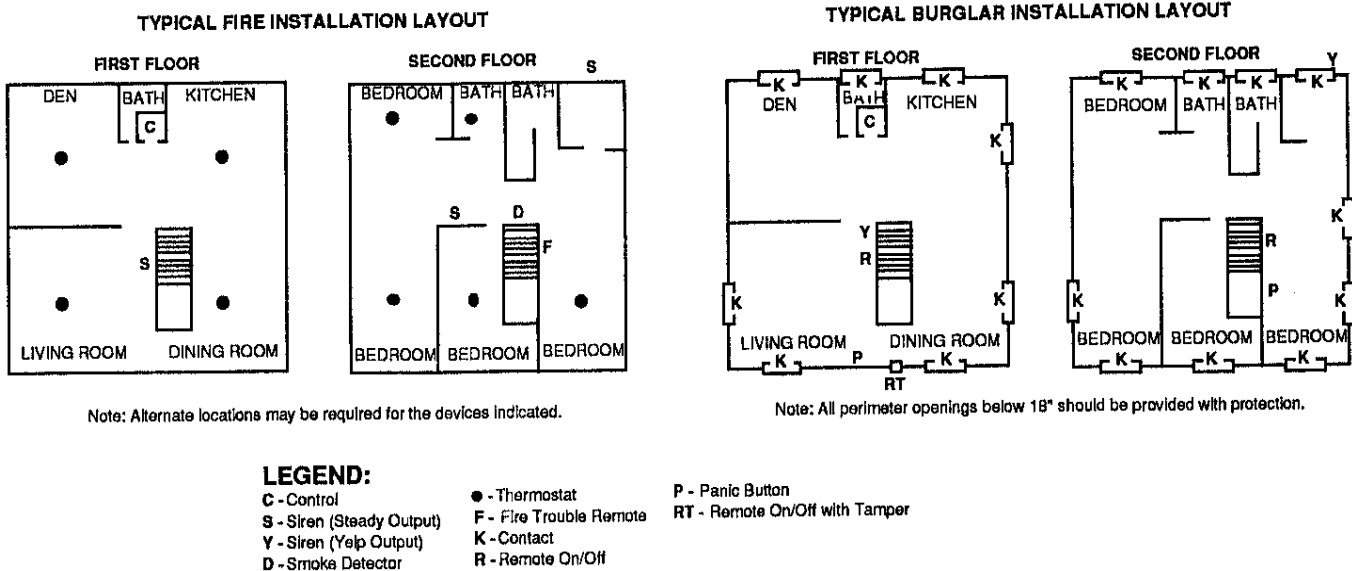

**FIGURE 1 TYPICAL INSTALLATION LAYOUT**

### 3. PARTS DIAGRAM & DESCRIPTIONS

The system is specially packed to allow you to pull out the electronics, control station and power supply in one piece so that they can be kept clean and safe while you proceed with the necessary "rough in" work. The parts included with a complete system are shown with packing materials removed. Please familiarize yourself with the part names as this manual will refer to the system components periodically.

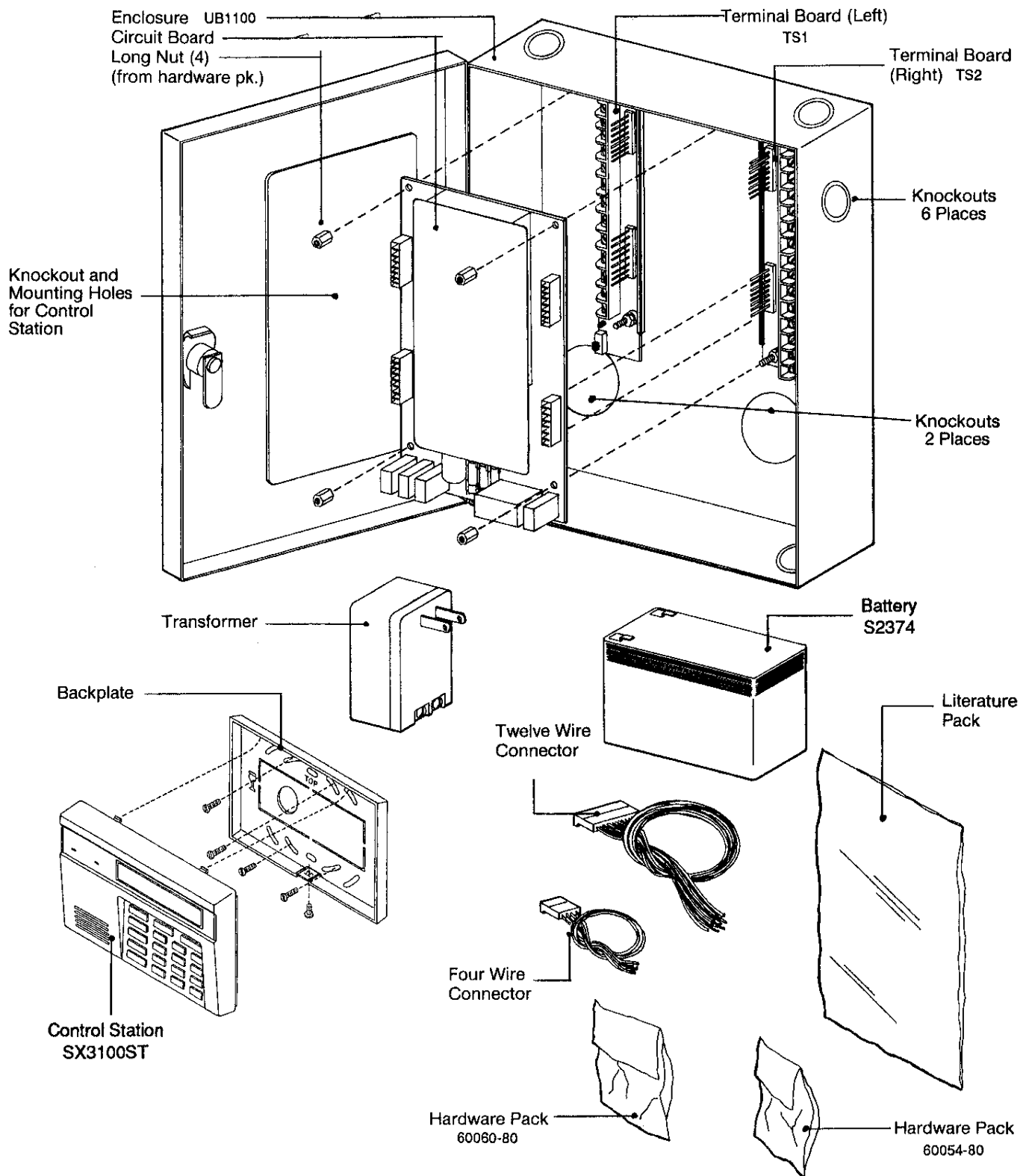

FIGURE 2 SX-3100LCD PARTS LIST

## 4. MOUNTING, WIRING AND TERMINAL DESCRIPTIONS

- 1) Select a proper mounting location. The control must be mounted in a secure, dry location capable of maintaining an ambient temperature inside the control box of 32 to 122 degrees Fahrenheit (0 to +50 degrees Celsius).
- 2) Remove package components from the enclosure and set aside until pre-wiring is completed.
- 3) Remove control box knockouts that best suit your wiring needs. Note that each knockout is a "dual" size. The "inside" knockout is for 1/2" conduit and the "outside" is for 3/4" conduit.
- 4) The control box has six mounting holes. Use the top center hole to temporarily hang the box. This will provide a reference for leveling and aligning the other five holes.
- 5) The master power switch is located on the left terminal board. Verify that this switch is in the OFF (down) position.
- 6) Proceed to pull all necessary wiring for the power transformer, detection loops, control stations, siren outputs, etc.
- 7) Once all field wiring has been brought into the enclosure, it should be terminated as per the instructions on the following pages, prior to plugging in the electronic circuit board. This not only helps to prevent physical damage to the board but also allows the convenience of pre-wiring for new construction, etc.
- 8) When wiring terminations are complete proceed to step 19 (INSTALLING THE CONTROL BOARD), which describes the proper procedure for plugging-in the circuit board.

### 9) EARTH GROUND (TERMINAL #19)

In order for the control's lightning and transient protection to be effective, terminal #19 must be connected to an earth ground. Finding a proper ground path may effect selection of the control mounting location as it is important to run the ground wire as short as possible.

An ideal ground for a security system is a "UNIFIED EARTH GROUND", whereby the power line, telephone, and security system ground rods are bonded together. This type of ground eliminates a common problem during lightning strikes known as "STEP VOLTAGE BLOWOUT". Step voltage is a measurable voltage potential between different earth ground stakes during a lightning strike, which results in a destructive current flow path through the security equipment.

Ground wires should be run the shortest and straightest path between the equipment and the ground rod. Avoid sharp 90 degree turns as they can cause undesired inductance in the earth ground path. This inductance blocks the lightning path to earth ground causing the lightning current to run through the security equipment.

### POINTS TO REMEMBER WHEN GROUNDING

1. Use a minimum 14 gauge solid wire.
2. Keep wire runs short. No 90 degree or sharp turns.
3. Use a minimum radius of 8 inches for bends.
4. Run ground wires separate from other wires.
5. Use 8 foot copper clad ground rods.
6. Route toward earth and never away.
7. Never run parallel to metal without properly bonding to the metal.

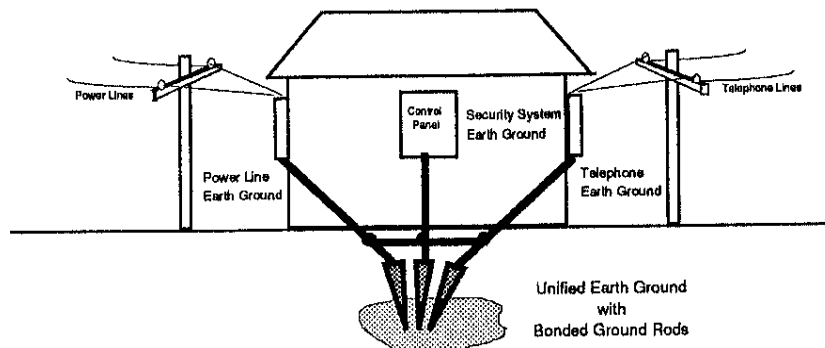

FIGURE 3 UNIFIED EARTH GROUND

## 10) AC TRANSFORMER (TERMINALS 17 & 18)

The control is powered by an 18 volt 35 VA minimum, internally fused, UL listed, Class II transformer (PART # 8003-000).

**CAUTION: Never short the terminals of the transformer together. This will cause the internal fuse to blow. Never replace with or substitute a transformer of less than minimum stated rating. The transformer must be connected to a 120 VAC 50/60Hz 24 hour power outlet not controlled by a wall switch.**

- Verify that the master power switch is turned off. (Figure 5).
- Connect the transformer to terminals 17 & 18 of the control using 18 gauge minimum, 2 conductor wire (maximum length 50 feet).
- Do not plug the transformer in at this time.

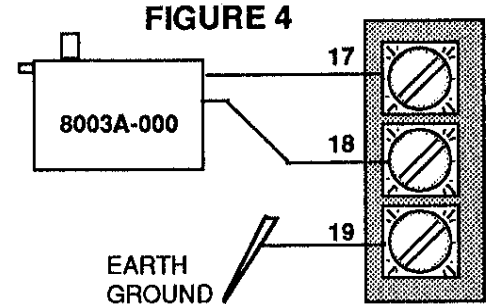

FIGURE 4.

**NOTE: Final connection of the AC transformer and standby battery should be left undone until ALL wiring is completed. The master power switch on the left terminal board controls both battery and AC power.**

## 11) STANDBY BATTERY (RED AND BLACK LEADS)

The control was designed to operate with a rechargeable 12 Volt 6 Amp hour sealed lead acid battery (Model # S-2374) as a primary power back up. The float charge voltage for the battery is set for 13.8 Volts at 400 milliamps (mA) maximum, while the system is delivering its rated continuous output current. Current in excess of 400 mA can be delivered to the battery if the system is delivering less than the rated power. The battery charging current is limited through a 5 Ohm resistor.

The battery automatically takes over and provides power in the event of an AC power outage. The battery is also supervised. If the AC fails for an extended period and the battery voltage drops below 11.2 volts, the low battery detector will activate and cause the control station prealarm to beep, its' power LED to blink and the digital communicator to report to the central station if so programmed. The beep can be silenced with the " \* " key. The power LED will flash until the battery is manually or automatically tested and passes the test. The control performs a dynamic load test on the battery every 24 hours. A relay places a 2.5 Amp load across the battery for 5 seconds and the battery voltage is detected during the test. The low battery detector will activate if the battery fails the load test.

If the battery voltage should ever drop below 7.5 Volts, the microprocessor will shut down, but there will still be auxiliary equipment current drain on the battery. A part #2575-000\*\* low battery cutoff module may be added to disconnect the battery and protect it against deep discharge.

- Place the battery in the enclosure. Make sure that the power switch is in the OFF position.
- Connect the black battery wire to the black battery terminal marked "-".
- Connect the red battery lead to the red battery terminal marked "+".

NOTE: A reverse current diode provides some protection to the electronics if the power leads are accidentally reversed.

**DO NOT LEAVE THE LEADS REVERSED. OVERHEATING OF RESISTOR R9 WILL RESULT.**

- Leave the power switch in the off position.

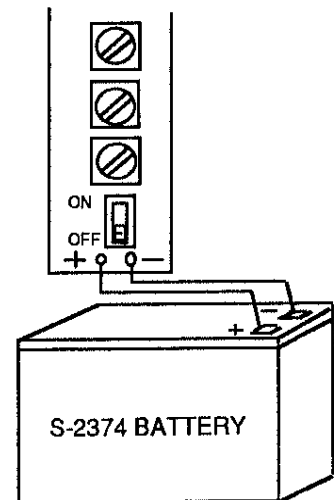

FIGURE 5.

\*\* This is not a U.L. listed device.



## 12) HARDWIRE ZONE INPUTS (TERMINALS 1 - 12)

The system provides eight(8) individually programmable class "B" end-of-line resistor supervised detection zones. If desired, any of the zones may be converted from class "B" E.O.L. resistor supervised to non-supervised closed circuit only. The system may be expanded to 16 zones by adding the optional SX-3104 Zone Expansion Board. Each hardwired zone may be configured as a burglar, 24 hr. Auxiliary "A" (fire *ff*), 24 hr. Auxiliary "B" (police), 24 hr. Auxiliary "C" (emergency), or communicator report only zone. In addition, a single zone may be programmed to allow system key switch operation. Each of the eight zones may be further defined with various options and sub-options. The ZONE PLANNING GUIDE in the programming section assists in planning each zone. The control also allows individual or group subzoning by specific user codes. See SPECIAL FEATURES, SUBZONING.

### • CLASS "B" END-OF-LINE RESISTOR SUPERVISED ZONES

In order to function properly as a class "B" supervised circuit, a zone must have a 2,200 Ohm 1/4 watt resistor installed in series at its furthest most remote end from the control. This configuration allows both open and closed circuit contacts to be used on the same loop and provides a high degree of protection against compromise or tampering. The control constantly measures the resistance on a class "B" zone and is able to determine by a proper reading of approximately 2,200 Ohms, that a zone is secure and intact. It can respond differently to a high resistance (loop open) versus a low resistance (loop short). For example, a class "B" fire (*ff*) zone reacts with a supervisory/trouble condition when opened and an alarm when shorted. Supervisory/trouble is a programmable sub-option for each of the other five zone types. There is even a choice of whether a trouble should be on an open or short. For more information see "SPECIAL FEATURES, SUPERVISORY/TROUBLE ZONE SUB-OPTION". The system comes equipped with eight 2,200 ohm 1/4 watt resistors, one for each zone. The resistors are color coded red • red • red and either a gold or silver for the fourth band.

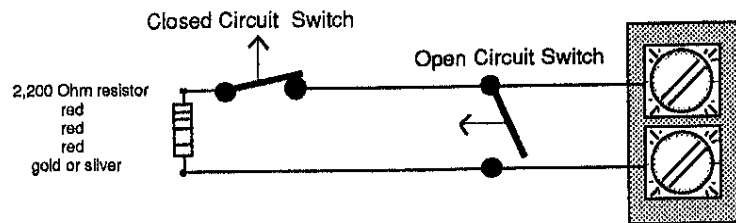

FIGURE 6. E .O.L. RESISTOR SUPERVISED LOOP

Any loop short or open will greatly change circuit resistance and violate the zone. The resistor must be placed at the end of the loop.

### • NON-SUPERVISED CLOSED CIRCUIT LOOP (NO E.O.L. RESISTOR SUPERVISION)

If end-of-line resistor supervision is not desired, a conventional closed circuit loop may be connected directly to the appropriate zone input terminals by first cutting a corresponding zone jumper on the control board. See FIGURE 8 and FIGURE 18. These jumpers are labeled Z-01 thru Z-08. The same applies to zones 09 - 16 when an optional SX-3104 Zone Expander is used.

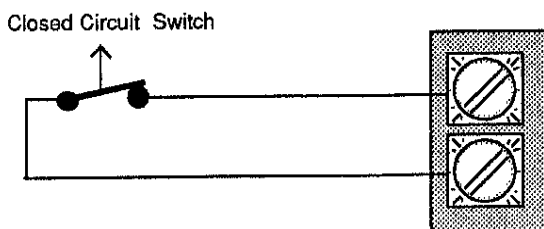

FIGURE 7. NON-SUPERVISED CLOSED CIRCUIT LOOP

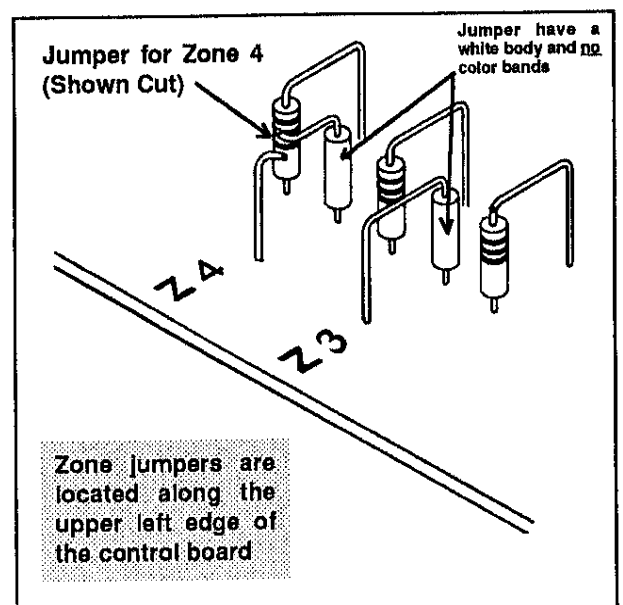

FIGURE 8. NON-SUPERVISED ZONE JUMPERS

Figure 9 is an example of how each of the detection zones might be configured in a typical installation. For ease of explanation zones, 01-08 are shown in their factory default programming configuration. They may of course be re-programmed to suit the specific needs of each installation. At this point it is only necessary to decide what each zone will be used for and make the necessary connections. Programming the actual zone definitions and responses will be explained under the section titled "PROGRAMMING THE CONTROL".

- Decide whether zone is to be wired as an end-of-line resistor supervised circuit or a non-supervised closed circuit only.
- Connect all alarm sensors to the zone wiring as per the instructions provided by the individual sensor manufacturer and figures 7 and 8 in this manual.
- Connect each zone wire to the appropriately labeled terminals as per Figure 9. Each zone has an input terminal and a common (negative) return. Please note that a negative terminal is shared by two zones and that all negatives are common to each other.
- Cut corresponding zone jumper if end-of-line resistor supervision is not required (see figure 8 ).
- If 12 volt D.C. powered detection devices such as motion sensors are being installed, refer to section "DC POWER OUTPUTS".
- Define each zone utilizing the ZONE PLANNING GUIDE and program the zone definition value into the corresponding function location. See "PROGRAMMING THE CONTROL".

NOTE: Zones fault when loop resistance is greater than 9,800Ω or less than 1290Ω.

- Zone-01)** Burglar Delay-1 zone, 60 second exit and 30 second entry time. Typically used for main entry door(s).
- Zone-02)** Burglar Delay-2 zone 60 second exit and 45 second entry time. Typically used for second entry point.
- Zone-03)** Burglar Instant Interior zone. Used for motion detectors, mats, and other interior traps.
- Zone-04)** Burglar Instant Perimeter zone. Shown with corresponding zone jumper cut and thereby used with closed circuit devices only and without the end-of-line resistor.
- Zone-05)** Burglar Instant Perimeter zone. Shown with end-of-line resistor used.
- Zone-06)** Burglar Instant Perimeter zone. Shown with open and closed circuit devices in the same loop.
- Zone-07)** Burglar Instant Perimeter zone. Shown with end-of-line resistor attached directly to panel when zone is unused or when bench testing.
- Zone-08)** 24 hr. Auxiliary "A" (fire ff) zone. Shown with open circuit sensors wired in parallel. An open or cut within the loop wire will result in a trouble condition.

NOTE: ZONES ARE FACTORY DEFAULT

FIGURE 9 TYPICAL ZONE WIRING EXAMPLE

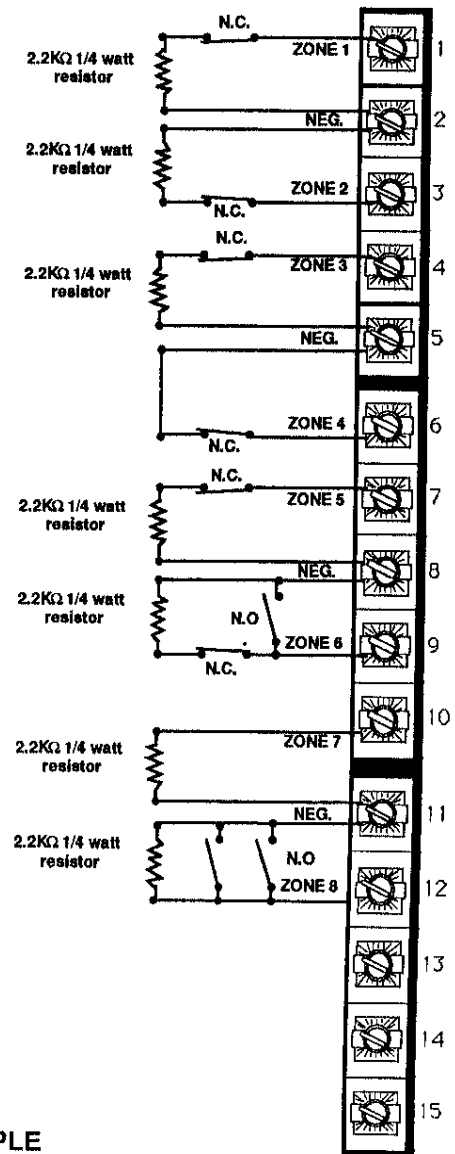

- **24 hr. AUXILIARY ZONES**

Zones defined as 24 hr. Auxiliary "A", Auxiliary "B" or Auxiliary "C" can be wired as E.O.L. resistor supervised or non-supervised (closed circuit only) and are commonly used for Fire (*ff*), Police or Emergency inputs however they may also be used for other devices requiring 24 hr. supervision. A 24 hr. Auxiliary defined zone provides an alarm upon a loop short utilizing open circuit sensors and provides a supervisory/trouble upon an open or break in the loop. As previously mentioned, Auxiliary "B" and Auxiliary "C" defined zones can also be programmed with the supervisory/trouble sub-option.

- **24 hr. COMMUNICATOR REPORT ZONE**

Communicator report only zones can be wired as E.O.L. resistor supervised or non-supervised (closed circuit only). When activated they provide no keypad indication or panel outputs and are therefore intended for simply reporting conditions from temperature sensors, water sensors, etc.

- **KEYSWITCH ZONE**

A single zone may be programmed to allow the system to be armed/disarmed with one or more momentary or maintained (shunt) contact key switch(s). This zone may also be wired as E.O.L. resistor supervised or non-supervised (closed circuit only). If wired with the E.O.L. resistor and programmed with the supervisory/trouble definition, a tamper switch may be wired to disable the keyswitch arm/disarm capability if the zone is violated. (Refer to "SPECIAL FEATURES, KEY DEFINED ZONE).

### 13) CONTROL STATION WIRING (TERMINALS 13,14,15,16)

The control stations connect to the control terminals using only a four conductor cable. Four wire cable of 22 gauge (or larger) is satisfactory for this hook-up however stranded wire provides additional resistance to bending and breakage. A shielded cable with the control end connected to earth ground provides additional protection from lightning. A four wire unpluggable connector is supplied with the control station. This allows a convenient way of roughing in the wiring then simply "plugging in" the keypad at a later time. Note that the plug is polarized and will plug in only one way. Follow the color code as shown in Figure 11 and connect the field wiring to the control, then simply splice the four wire connector to the control station end of the cable.

A maximum of seven LED STYLE remote control stations may be connected to the control. The optional LCD display control stations draw greater amounts of current depending upon the brightness setting of the backlighting and downlighting lamps. Consult the LCD control station installation manual for calculating maximum LCD control stations per system.

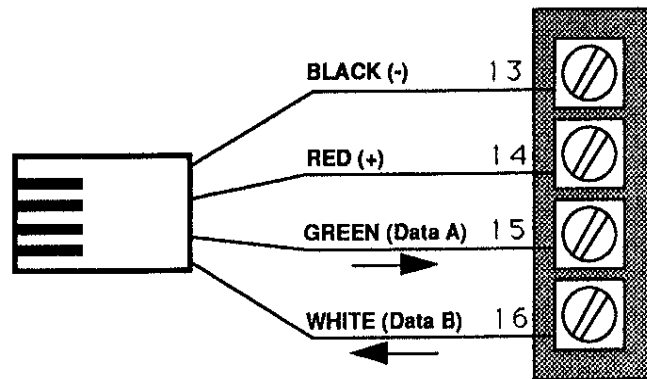

**FIGURE 10 CONTROL STATION WIRING**

## 14) CONTROL OUTPUTS

Alarm outputs and various other function outputs are accessed through circuit board connector J-16 (See Figure 18). A 12 pin plug in type connector with color coded flying leads is provided to plug into connector J-16 ( See Figure 2). Outputs 3 thru 12 are capable of triggering control board Relays K-1 or K-2, an optional SX-3190 Relay Board \*\*, or any auxiliary device that either consumes less than 50 milliamps at 12 Volts DC or that has a low current trigger input. More than one of these outputs can be used to trigger the same low current trigger terminal. For example, Auxiliary "B" and burglar outputs (10 and 12) can both be connected to terminal 23 (Relay K-1 positive trigger input). Outputs 1 and 2 provide positive and negative auxiliary power for powering accessories.

Pin (lead)	Function	Description
1. Red	+12 Volt DC	For powering accessories, this output is fused at 2.5 Amps. Maximum combined continuous current drain from terminals 14, 29, 30, 31 and connector J-15 and J-16 should not exceed the limit as specified in Table 1. Combined alarm condition current drain should not exceed the limits as specified in Table 1.
2. Black (-)	Negative	Common power supply (Same as terminals 2,5,8,11,13, and 28)
3. White	Access	Provides a (+) 12 VDC output when an ACCESS code is entered at the keypad. This output may be programmed as latching or timed output through program function 26.
4. Green	Lamp	Provides a 2 minute (+) 12 VDC output when any control station key is pressed, Output entry or exit delay begins, AC power fails, or when any type of alarm occurs. This output could be used to trigger a line carrier transmitter which could turn on or flash lamps or flood lights thru the use of various line carrier receivers.
5. Brown	Pre-Alarm	Provides a (+) 12 VDC output for a remote or auxiliary pre-alarm. This output activates during entrance delay warning and during all burglar, auxiliary "A", Auxiliary "B", and Auxiliary "C" alarms. This output does not activate upon control station key depressions and error tones.
6. Blue	Ready	Remote burglar zone ready indicator.
7. Orange	Violation	Provides a (+) 12 VDC output upon activation of any alarm condition. May be used to activate a strobe or auxiliary indicator. This output stays active until the system is disarmed or manually reset.
8. Yellow	Armed	Provides (+) 12 VDC remote burglar armed indicator. If closing reports are programmed this output will not be active until the kissoff has been received from the central station.
9. Purple	Auxiliary "C" (Emergency)	Provides a (+) 12 VDC output upon either a hardwired or control station activated Auxiliary "C" (Emergency) alarm.
10. Gray	Auxiliary "B" (Police)	Provides a (+) 12 VDC output upon either a hardwired or control station activated Auxiliary "B" (Police) alarm.
11. Pink	Auxiliary "A" (Fire ff)	Provides a (+) 12 VDC output upon either a hardwired or control station activated Auxiliary "A" (Fire ff) alarm.
12. Tan	Burglar	Provides a (+) 12 VDC output upon activation of a burglar alarm.

FIGURE 11 CONNECTOR J-16 DESCRIPTIONS

**CAUTION:** J-16 Outputs 3 thru 12 provide a maximum of 50 milliamps each and cannot directly drive high current draw devices such as a siren driver. Damage to the control board will result. Power for high current devices must be obtained from terminals 29, 30, 31, or J-16 Pin 1 and can be switched through Relay K1, K2, or an optional SX-3190 \*\* relay using the J-16 outputs to trigger the relays.

\*\* This is not a U.L. listed device.

### 15) RELAYS K-1 & K-2 (TERMINALS 20 - 27)

Auxiliary relays K1 and K2 are general purpose form C relays with 5 Amp contacts. They may be triggered by a low current (50mA) +12 Volt DC applied to terminal 23 for relay K1 or terminal 27 for relay K2. These relays allow the low current outputs of connector J-16 to activate high current loads such as sirens, bells, strobes, door strikes, etc. See Figure 12.

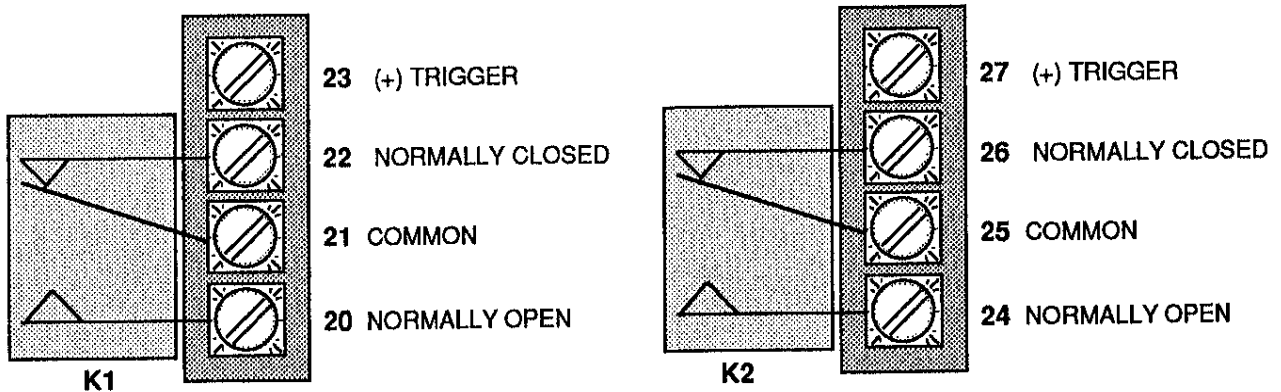

FIGURE 12 RELAY K1 / K2

**NOTE:** Maximum continuous current drain from terminals 14, 29, 30, 31, and connector J-15 and J-16 should not exceed the limits as specified in table 1. Maximum current drain under alarm conditions should not exceed 1.7 Amps. When replacing fuses, always use 3AG type with the proper current and voltage rating.

### 16) DC POWER OUTPUTS (TERMINALS 28,29,30,31)

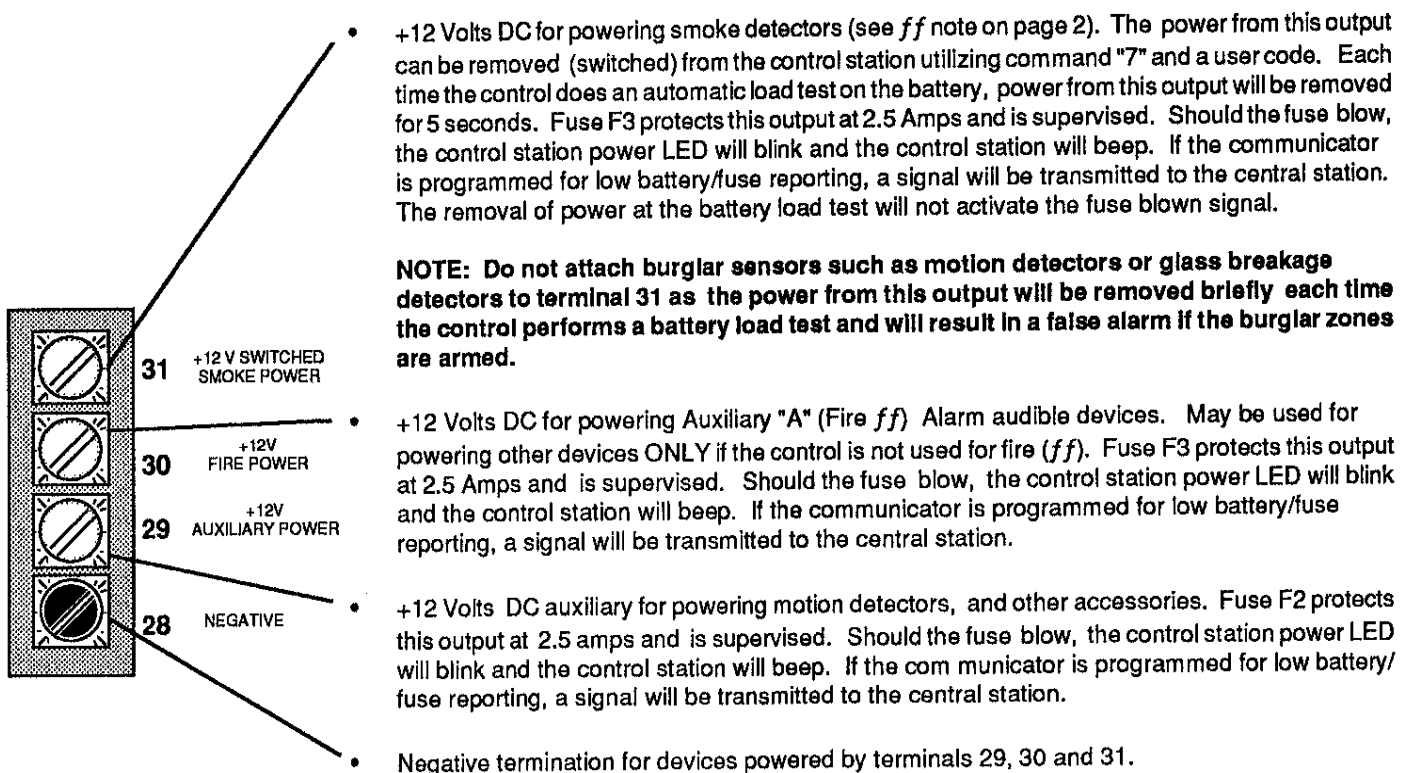
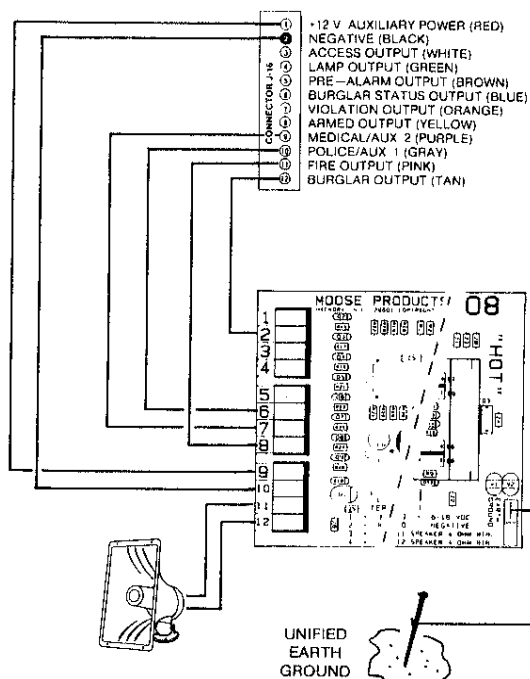

FIGURE 13

## 17) SIREN HOOKUPS

There are two basic types of electronic siren drivers, (1) **Low current triggered** and (2) **Directly powered**. The **low current triggered siren driver** obtains its operating power from a (+) positive and (-) negative constant voltage terminal input. Separate inputs terminals are available for triggering or activating the desired siren sound. Since all of the high current requirements are obtained from the constant voltage terminals, the triggering terminals require only a small amount of current (typical 15-30 milliamps) for activation. An example of a siren driver which is low current triggered is the SX-3120. This is an ideal siren for use with this control since the J-16 outputs are restricted to 50 milliamps maximum. Of course the two relays K1 and K2 can be used to switch high current loads, however, if a low current triggered siren is used, wiring will be more simple and the relays will be free for other uses. A **directly powered siren** utilizes a single high current input to directly drive the siren circuitry and produce sound. This category includes non-triggered siren drivers (SX-3121, SX-3122, etc.) and self contained siren (SX-3142). Self contained sirens are typically a single unit as opposed to the more common two piece electronic siren board and separate speaker. Regardless of the type, directly powered sirens require the use of Relays K1 or K2 to switch the higher current demands and the J-16 outputs to activate or trigger the relay contacts.



**SX-3120 Siren Hookup**

Note that the relays aren't used at all. Since this driver requires less than 50 milliamps to trigger, it can be triggered directly from J-16 outputs 11 and 12 with operating current supplied from terminals 28 and 29.

**FIGURE 14 LOW CURRENT TRIGGERED SIREN DRIVER †**

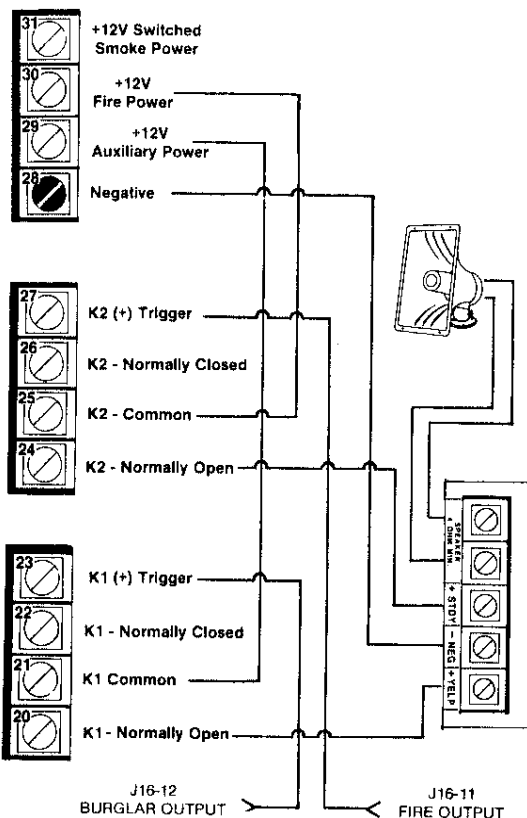

**SX-3121 Siren Hookup**

J-16 output leads 11 and 12 are used to trigger relays K-1 and K-2. Terminal 28 provides the common negative while terminals 29 and 30 provide positive power to drive the high current power for the burglar and fire sections of the driver. Each is independently switched through the normally open contacts of the relays. It's also possible to use more than one J-16 output to trigger the same relay.

**FIGURE 15 DIRECTLY POWERED SIREN OR STROBE, etc. †**

† For U.L. installations, use only U.L. listed audible devices and wire as indicated in Figures 19 and 20.

### 18) TELEPHONE LINE CONNECTION (TERMINALS 32 - 35)

Terminal 32 and 33 are the inputs for the incoming telephone line. Terminals 34 and 35 are outputs which go to the house phones. The telephone line runs through a line seizure relay within the control. Whenever the control is idle, this relay completes the connection. When the control needs to communicate with the central station, this relay disconnects the house phones from the system, leaving only the communicator connected to the incoming lines. This prevents communication interruption caused by picking up of a house telephone within the protected premises. For proper installation and to meet FCC requirements, an approved USOC RJ-31X or RJ-38X "Telephone Jack" and a matching 8 pin modular "Direct connect cord" must be installed. The purpose for this is to provide an isolation and disconnection point between the local telephone system and the control's Digital Communicator for telephone company troubleshooting. An RJ-38X jack is a standard RJ-31X jack with a jumper installed between terminals 2 and 3 to allow a tamper loop for supervising the connection. (See Figure 16) When ordering either jack the telephone company will need the following information.

1. Required Jack: USOC RJ-31X OR RJ-38X.
2. The telephone number of the line that jack is to be installed on.
3. Requested location at which jack is to be installed.
4. Digital Communicator FCC Registration number: DLH66Y-12286-AL-E
5. Ringer Equivalence: 0.0B
6. Equipment Manufacturer: NuTone, Inc.

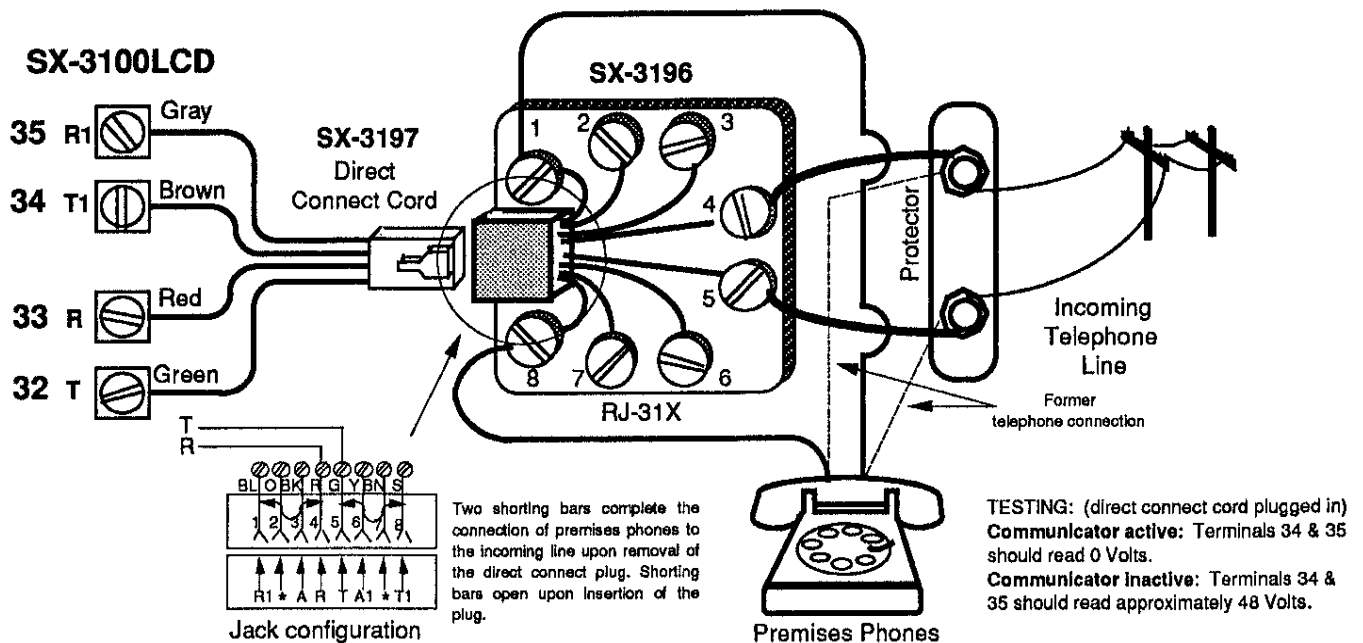

**FIGURE 16 TELEPHONE SYSTEM CONNECTION**

#### ADDITIONAL TELEPHONE COMPANY INFORMATION

##### INCIDENCE OF HARM

In the unlikely event that the communicator should ever cause harm to the telephone network, the telephone company will notify the telephone subscriber that temporary discontinuance of service may be required; however, where prior notice is not practicable, the telephone company may temporarily discontinue service. In the case of temporary discontinuance, the telephone company shall promptly notify the telephone subscriber who will be given the opportunity to correct the situation. The customer also has the right to bring a complaint to the FCC if he feels the disconnection is not warranted.

##### CHANGES IN TELEPHONE COMPANY EQUIPMENT OR FACILITIES

The telephone company may make changes in its communications facilities, equipment, operations or procedures, where such action is reasonably required and proper in its business. Should any changes render the communicator incompatible with the telephone company facilities, the customer shall be given adequate notice to make modifications to maintain uninterrupted service.

##### NOTIFICATION

This equipment complies with Part 68 of the FCC rules. All connections to the telephone network must be made through standard plugs and standard telephone company jacks, or equivalent, in such a manner as to allow for easy and immediate disconnection of the alarm equipment. If the connecting cord is unplugged from the jack there shall be no interference to the telephone equipment still connected to the telephone network.

Notify the telephone company if the communicator is removed from the premises and the RJ31-X or RJ38-X jack is no longer needed.

##### MALFUNCTIONS OF EQUIPMENT

In the unlikely event that the system should ever fail to operate properly, it should be disconnected from the RJ31-X or RJ38-X jack to determine if the problem is with the telephone network or with the security system. If a problem is found with the communicator, leave disconnected until repaired or replaced.

The FCC prohibits customer-provided terminal equipment be connected to party lines or to be used in conjunction with coin telephone service. Inter-connect rules may vary from state to state.

## 19) INSTALLING THE CONTROL BOARD

- Make sure that the Master Power Switch is off (down position). This switch is located below Terminal 19.
- Carefully work the board down over the connectors until fully seated. Install the four long hex nuts (packed in the small hardware bag) and screw them onto the four studs protruding through the control board.
- Plug in the J-16 wiring harness.
- Do not turn power on at this time. When all terminations are complete, proceed to the section titled "POWER-UP AND CONTROL STATION OPERATION".

TERMINAL	FUNCTION	DESCRIPTION
1	Zone 1 loop (+)	<div style="border: 1px solid black; padding: 5px;">                     Each loop requires a 2200 ohm end-of-line resistor. Closed circuit and open circuit devices may be connected within each loop. If a non-supervised closed circuit devices ONLY loop is desired, a jumper for each loop may be cut to eliminate the need for an end-of-line resistor. A common negative or return is shared between each group of two (2) zones.                 </div>
2	Zone 1 & 2 common	
3	Zone 2 loop (+)	
4	Zone 3 loop (+)	
5	Zone 3 & 4 common	
6	Zone 4 loop (+)	
7	Zone 5 loop (+)	
8	Zone 5 & 6 common	
9	Zone 6 loop (+)	
10	Zone 7 loop (+)	
11	Zone 7 & 8 common	
12	Zone 8 loop (+)	
13	Control station common (-) negative	Connect black (-) wire from control stations.
14	Control station (+) positive	Connect red (+) wire from control stations.
15	Control station data in	Connect green wire from control stations.
16	Control station data out	Connect white wire from control stations.
17	AC input	Connect 18 VAC 35VA transformer.
18	AC input	Connect 18 VAC 35VA transformer.
19	Earth ground	Connect to a dedicated metal stake ground for best results.
20	Relay K-1NO	Relay K-1 and K-2 may be utilized for switching power for sirens, strobes, lamps, etc. Relay K1 or K2 may be triggered from a 12v (+) positive source such as the J-16 outputs.
21	Relay K-1 common	
22	Relay K-1 NC	
23	Relay K-1 (+) trigger	
24	Relay K-2 NO	See description above.
25	Relay K-2 common	
26	Relay K-2 NC	
27	Relay K-2 (+) trigger	
28	Common (-)	Common power supply negative.
29	Auxiliary power (+)	(+) 12 volts DC power for motion detectors and other accessories. This output is fused at 2.5 amps. Maximum continuous current drain from 14, 29, 30, 31, and connectors J-15 and J-16 outputs should not exceed the limits in Table 1. Combined alarm condition current drain should not exceed 1.7 amps.
30	Auxiliary (Fire ff) Power (+)	(+) 12 volts DC power for auxiliary (fire ff) annunciation devices. This output is fused at 2.5 amps.
31	Switched Power (+)	Switched (+) 12 volts DC. Command 7 from the keypad will temporarily remove power from this terminal for resetting smoke (See ff note on page 2) detectors.
32	Incoming telephone line (T) "TIP"	Green wire from RJ-31X direct connect Telephone cord
33	Incoming telephone line (R) "RING"	Red wire from RJ31X direct connect Telephone cord.
34	House phone connection (T-1)	Brown wire from RJ31X direct connect Telephone cord.
35	House phone connection (R-1)	Gray wire from RJ31X direct connect Telephone cord

**FIGURE 17 TERMINAL DESCRIPTIONS & QUICK REFERENCE GUIDE**



**LOOP JUMPERS TO ELIMINATE THE END-OF-LINE RESISTORS**

If any of the zones 1-8 are to be used as standard closed circuit loops (no end-of-line resistor), the corresponding jumper(s) Z1-Z8 must be cut. These jumpers are labeled J1 thru J8.

**PROGRAM SWITCH**

This switch must be momentarily pressed before the installer level programming may be accessed. When pressed, a 3 minute timer starts. Each time a key is depressed while in the program mode, the 3 minute timer is restarted. If entries cease for three minutes, the control exits to normal mode and the switch must be again pressed. Control stations beep as long as the program switch is held closed.

**CONNECTOR J-17**

For plugging in a control station at the control box. A two-ended cable, Part # 8785-000, must be used.

**POWER LED**

Lights when AC power is applied and power switch is in the ON position.

**POWER SWITCH**

Turns on or off all AC and DC power to the control.

**A C M INPUT**

Input for an optional Answer Command Module which allows the Upload/Download feature to work on a phone line which has an answering machine attached.

**DIALER ACTIVE**

Lights when the communicator seizes the telephone line and starts the dialing process. The LED goes out when the communicator receives a kissoff from the Central Station receiver.

**GROUND START**

Provides a low current output from +12V to ground (0 volts) when the pulse dial relay is active.

**COMMUNICATOR LISTEN-IN INPUT**

Port for injecting the audio signal from a listen-in microphone amplifier and line filter onto the telephone line when audio listen-in is being used. A listen-in output trigger is located on the SX-3101 output expander.

**J-15 PROGRAMMER CONNECTOR**

Also for plugging in an optional Zone expander or SX-3101 output expander.

**PIN SLB**

Output for Slave operation mode. (See SPECIAL FEATURES)

**J-16 OUTPUT CONNECTOR**

Provide most all of the alarm and system status outputs.

**PIN SLA**

Input for Slave operation mode. May also be used with a shunt keyswitch to slave arm the control. (See SPECIAL FEATURES)

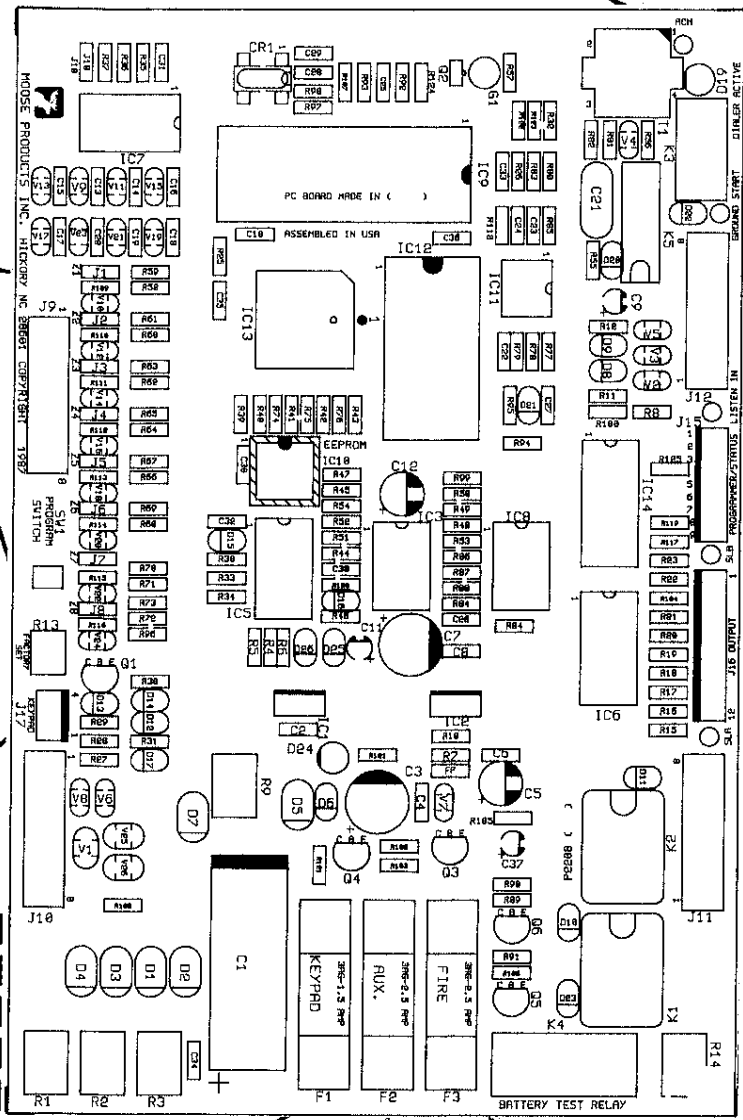

**FUSE F-1 (KEYPAD)**  
3AG 1.5 amp. fuse for powering keypad terminal 14.

**FUSE F-2 (AUXILIARY)**  
3AG 2.5 amp. fuse for auxiliary power output terminal 29 and J-16 terminal pin lead 1.

**FUSE F-3 (FIRE ff)**  
3AG 2.5 amp. fuse for powering terminals 30 and 31.

**NOTE:** Fuses are constantly monitored by the control. If F-2 or F-3 should blow, the keypad POWER lamp will blink and the control station will beep. The beeping may be silenced by pressing the " \* " key. After replacing the fuse, the power lamp will continue to blink until a manual battery test (command 7) is performed or the control performs an automatic battery test. A factory replaceable foil fuse protects the controls internal +12 volt and +5 volt circuits.

**FIGURE 18 CONTROL BOARD COMPONENT LAYOUT**

Telephone connection of a fire alarm signal from this system to a fire alarm headquarters or central station is permitted only with the approval of the local authority having jurisdiction. Phone plug mates with RJ31-X or RJ38-X Jack.

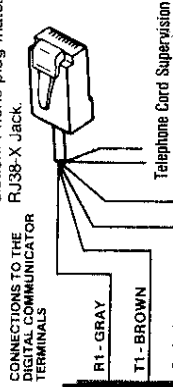

Telephone Card Supervision

Complies with Part 68 FCC Rules, FCC Reference: No. DA-69-1224, C.C. Single End-to-End, 0 CS, Use USOC RJ-31X or RJ-38X connector.  
Complies with the limits for class B computer devices in accordance with the specifications of subpart J of part 15 of FCC rules.

- +12V AUXILIARY POWER
- NEGATIVE
- +ACCESS OUTPUT
- +LAMP OUTPUT
- +PRE-ALARM OUTPUT
- +VIOLATION OUTPUT
- +ARMED OUTPUT
- +AUX.C (EMERGENCY) OUTPUT
- +AUX.B (POLICE) OUTPUT
- +AUX.A (FIRE) OUTPUT
- +BURGLAR OUTPUT

**U.L. and CSFM NOTES:**

All wiring must be not less than No. 22 AWG and must be listed energy limited cable.  
Use Fire Marshal approved wire for California installations.  
Diode IN4003 (across the Burglar Bell) is for noise suppression.  
Smoke detector and motion detectors must operate over a voltage range of eleven (11) to fourteen (14) volts.  
Alarm sounding devices must be installed so that they are clearly heard in all sleeping areas and must operate over a voltage supply range of eleven (11) to fourteen (14) volts.  
Rating of K1 and K2 relay contacts: 5A at 28VDC.  
Maximum continuous current drain from terminals 14, 29, 30, 31, and connectors J15 and J16 (combined) should not exceed the limits per Table 1. The alarm condition (combined) current drain should not exceed 1700 milliamperes (1.7 AMPS).  
For U.L. household burglar alarm only applications, Zone 8 may be reprogrammed to a burglar type zone function.  
For U.L. household fire alarm only applications, Zones 4 through 8 may be programmed to a fire type zone function.

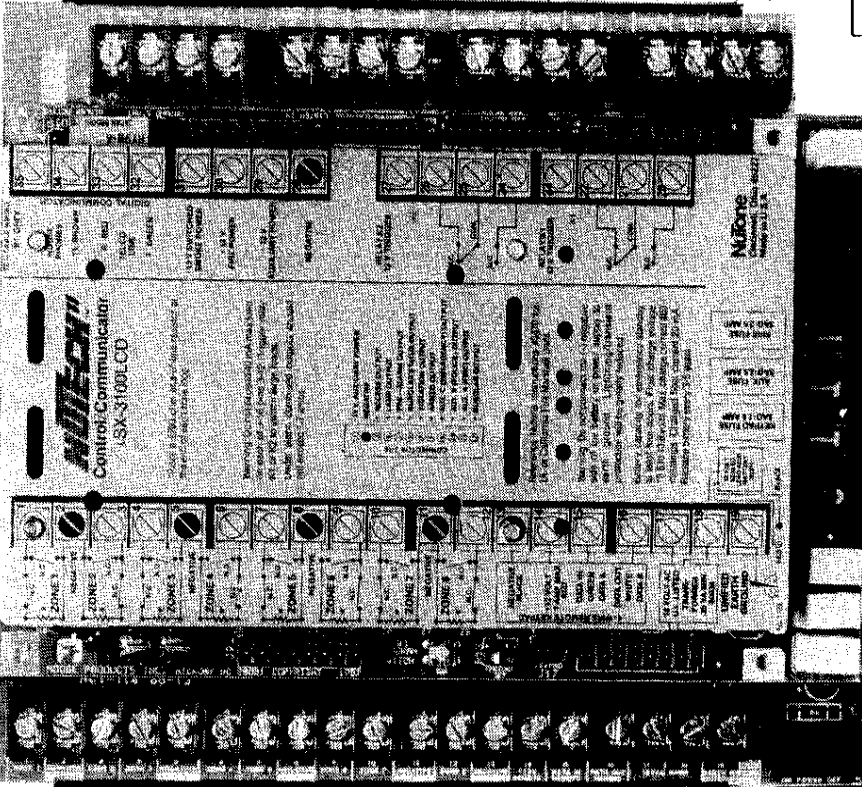

**NOTE FUSES:** Use only fast blow type 3 AG fuse of the appropriate voltage and amperage rating.

**NOTE:** Float-charge voltage 13.6 to 13.8 Volts  
Maximum charge-current 400 milliamperes  
Quiescent charge-current 20 milliamperes. Replace every 3 to 5 years.

**NOTE: NOT APPLICABLE TO HOUSEHOLD BURGLAR INSTALLATIONS**  
Hookup when Zone 8 is defined as Fire.

U.L. Listed Pyrotec Smoke Detectors, Head 305942 and Base R2942, or equiv.

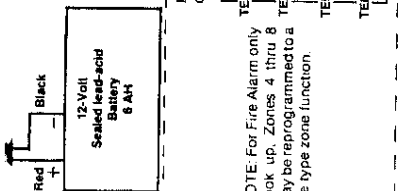

**NOTE:** For Fire Alarm only hook up, Zones 4 thru 8 may be reprogrammed to a fire type zone function.

★ 2200 OHM EOL RESISTOR MP1-211

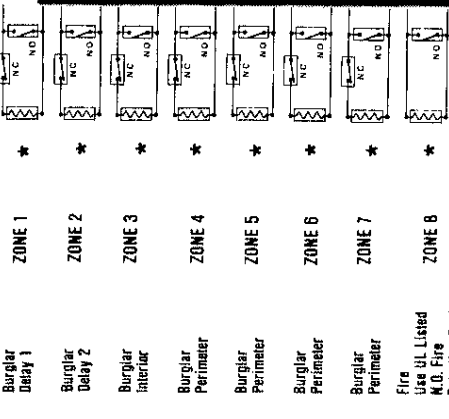

See NOTE 8 and NOTE 9

Use U.L. Listed N.B. Fire Detection Devices With EOL Resistor

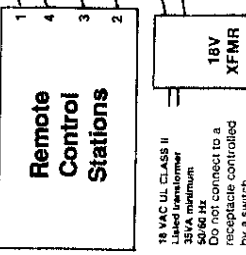

**NOTE:** Depress the Program Switch momentarily prior to Function Programming.

**LIGHTNING PROTECTION NOTE**

The control panel must be earth-grounded in order for lightning/transient protection to be effective. The ground-connection should be made to a dedicated metal-stake as close to the control as possible.

**NOTE:** This system should be tested weekly. All switches, contacts, and accessories must be UL-listed devices. This equipment should be installed in accordance with the National Fire Protection Association's standard #74 (National Fire Protection Association, Batterymarch Park, Quincy, MA 02269). Control panel specifications subject to change without notice.

FIGURE 19 SUGGESTED U.L. HOUSEHOLD BURGLAR ALARM AND/OR (FIRE ff) ALARM HOOKUP

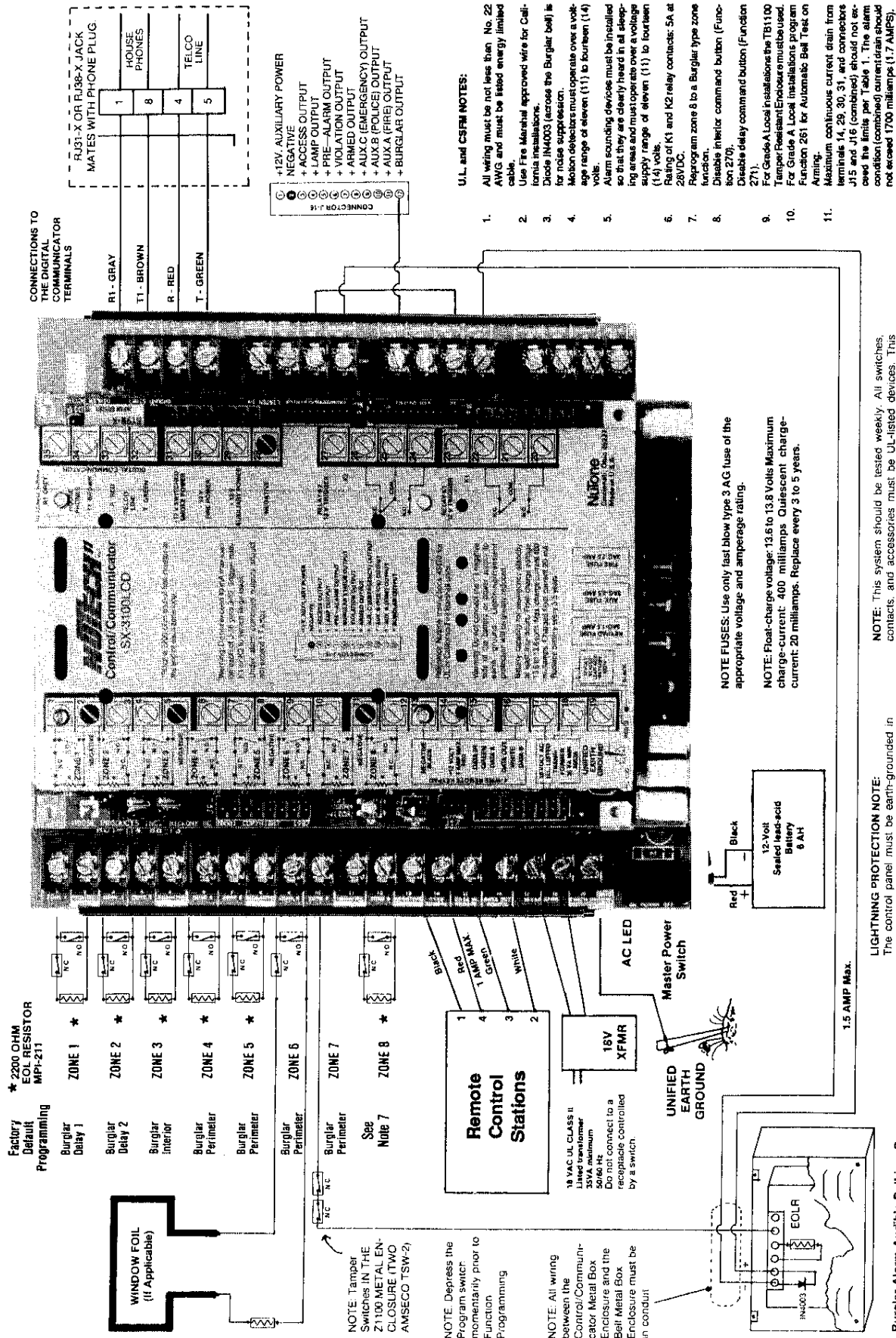

FIGURE 20 SUGGESTED U.L. COMMERCIAL BURGLAR ALARM HOOKUP

**THIS PAGE INTENTIONALLY LEFT BLANK**

## 5. POWER UP AND CONTROL STATION OPERATION

Before powering up the control, make certain that all connections are complete and the control board is properly plugged into the cabinet mounted terminal strips. This section assumes that the preceding sections have been read completely, that all terminal connections have been completed, the control station(s) have been installed and the entire system is ready to be turned on.

### 1) SYSTEM POWER-UP

Before powering up the control, verify that the AC transformer and battery are plugged in and connected. Switch the master power switch to "ON". The AC LED above the power switch should light. The control will also power up with DC power only but the power LED will not light. The control stations will now display the status of the system. All control stations will emit a 2 second tone and the four green LEDs, "Power", "Ready" (if zones are secure), "Interior On", and "Delay On" should light. If a control station does not power-up properly, pressing the " \* " key will reset the control station microprocessor and allow it to begin working properly.

- **WATCHDOG MONITOR . . . .** The watchdog monitor is a circuit that constantly monitors the operation of the microprocessor and keeps it working properly. For example, if the control does not power-up properly, or if an internal problem occurs, the watchdog monitor will perform a restart of the microprocessor. A ROM and EEPROM check is then automatically made and the system returns to the same operating condition that it was in when the problem occurred, with the following exceptions:

1. If the entry or exit alert is sounding and the entry zone is still violated, the system will shunt the violated zone and re-arm. Entry and exit time will be canceled.
2. If the system is in alarm, the alarm ceases and all violated zones will be auto shunted, then the system will re-arm.
3. If the system is communicating, the communication will be lost with the exception of alarm reports which are stored in non-volatile memory and will be re-transmitted.
4. The communicator/battery internal test time clock will be reset to zero. If the system is programmed for test reporting, the test report will be sent when the system resets; thus notifying the central station of an out of sequence test. The test time reporting is optional and is disabled from the factory.

- **AUTOMATIC SYSTEM DIAGNOSTICS UPON POWER-UP . . . .** Each time power is applied to the control, power-up diagnostics check the Read Only Memory (ROM) and the Electrically Erasable Programmable Read Only Memory (EEPROM). The EEPROM check is made any time the control is armed/disarmed and during automatic/manual battery tests as well. The ROM check consists of compiling a checksum of all the ROM bits and comparing the results with the checksum produced when the ROM was manufactured. A difference in the ROM will lock up the microprocessor and cause the control station LEDs to scroll, from top and bottom to center. If this should occur, the microprocessor is defective and the control board must be returned to the factory for replacement. The EEPROM check consists of compiling a checksum of all the bits in the EEPROM and comparing this with the checksum generated when the EEPROM was last programmed. A difference in the checksums will result in a memory error. This condition will be indicated on the control station by the sixth LED blinking. The beeping of the stations may be silenced by pressing the " \* " key. When an error has been detected, the function map should be read to determine the location of the change in information. The error message displayed on the control station will clear upon proper exiting of the programming mode.

### 2) GENERAL INFORMATION CONCERNING THE CONTROL STATIONS

- **CONTROL STATION SUPERVISION . . . .** Upon installation and power-up, each control station should be initialized with the control by manually pressing the " \* " key. If a control station data wire is then tampered with, mis-wired, or broken, or if a control station is disconnected from the main control, the supervisory/trouble LED on any remaining controls stations will begin blinking. The digital communicator can also be programmed to report this condition to the central station. If the faulted control station still has power connected, the control station LEDs will scroll from bottom to top for local identification.

- **EIGHT(8) SECOND TIMER . . . .** Whenever a key is pressed at a control station, the control panel allows eight seconds for the remainder of the code or function to be entered correctly. If an improper sequence is entered, the panel ignores further entries until manually cleared by pressing the " \* " key or automatically after eight seconds time of no key entries. A two second error tone will sound whenever the control automatically clears.

- **THREE(3) MINUTE TIMER . . . .** A three minute timer is started upon control station entry into the control panel programming mode. Three minutes after exiting the programming mode, or if no keys are pressed for a duration of three minutes while in the programming mode, the control station(s) emit a two second error tone and the control will return to the normal operating mode. This prevents inadvertent changes during the programming mode if not manually exited and allows a maximum time between program steps.

### 3) CONTROL STATION OPERATION

The control can be operated and programmed from either of two (2) classes of control stations. The standard control stations (SX-3130, SX-3131, SX-3132, AND SX-3136) display information thru LEDs. The optional SX-3100ST Security Terminal utilizes a LCD (Liquid Crystal Display) which prompts the user through each stage of operation in much the same way as a 24 hour bank teller machine. It has a convenient keypad downlight and LCD backlight which enhances operation. Up to seven(7) standard control stations may be used on a single system. SX-3100ST control stations draw varying amounts of current depending upon the settings of the LCD backlighting and downlighting. Consult the SX-3100ST instruction manual for determining the number of units that may be used on a single system. Whichever is used the maximum continuous current drain from the control should not exceed the limits as specified in Table 1.

**NOTE: This instruction manual specifically deals with operation of the standard control stations. Even so, most of the instructions pertain also to the SX-3100ST Security Terminal since the key commands were designed to work identical to the LED style control stations. The primary difference is the replacement of all but two of the LEDs with a forty-eight character Liquid Crystal Display and the ability to logically breeze through the operation with self-guided menu selections. Please consult the instruction and user manual of the SX-3100ST for specific differences and operating instructions.**

#### • CONTROL STATION COMMANDS

Control station commands are instructions given to the control when a selected key is pressed. The command digits include digits 0 thru 9 plus "#" and "\*". Command digits 0 - 9 must be followed by a User Authorization Code. The commands include: ARM/disarm, STATUS display, ALARM MEMORY display, INTERIOR ON/OFF, DELAY ON/OFF, MONITOR ON/OFF, SMOKE (*ff*)/BATTERY power reset and test, walk TEST, PROGRAM, SILENCE/RESET specific alarms and errors, activate ACCESS, and SHUNT (bypass) zones. These commands work on either the standard stations, however commands may also be accomplished on the SX-3100ST thru the use of the instructions displayed on the LCD display. See note above.

#### • "STANDARD" CONTROL STATION LED INDICATORS

The SX-3136 control station has eight multi-function LEDs which indicate system status, zone status, alarm memory, and provide a "window" into the more advanced features of the system. The LEDs display three "pages" or modes of information. See Table 2.

"Page 1" is the normal mode of operation. The function of each LED is explained on the front of the hinged door. In addition to the basic ON or OFF condition, each LED also has a blinking condition while displaying pages 1 & 2. The function of each blinking LED is explained on the inner label beneath the hinged door.

"Page 2" is the zone status mode accessed by pressing command "2" followed by a user authorization code. While in this mode, the LEDs display the status of each zone (secure, violated, shunted). The inner label beneath the hinged door identifies the zone number corresponding to each LED along with room for identifying the zone description. A sheet of peel and stick labels is provided for this purpose. Basically, when an LED is lighted the corresponding zone is violated, when blinking the zone is shunted.

"Page 3" is the alarm memory mode which is accessed by pressing command "3" followed by a user authorization code. While in this mode, the LEDs identify which, if any zones caused the most recent alarm. The same information on the inner label used for zone status is also used for alarm memory. A lighted LED identifies the zone(s) which caused the most recent alarm.

**NOTE: Because the control has the capability of expansion to 16 hardwired zones, "page 2" and "page 3" modes utilize an additional step to identify zones 09-16. While in either of these modes, pressing the command key again after the user authorization code, will cause the LEDs to display zones 09-16. The inner label has a description area beside each LED to label two zones (01/09, 02/10, etc.). Also, since each zone must be identified using two digits (01, etc.), please remember that shunting of a zone requires entry of both digits.**

## 5) CONTROL STATION ACTIVATED ZONES

There are three control station activated emergency zones, Auxiliary "A", Auxiliary "B", and Auxiliary "C". These zones operate independently of the eight hardwire zones and are active whether the burglar system is armed or not. These zones may be activated from the control station by pressing, and holding for approximately three seconds, specific pairs of keys. When a control station alarm is activated, the station beeps and displays information to indicate the condition. Each zone may be programmed to report the alarm to the central station. Auxiliary "B" may be programmed to be visually and audibly "silent" at the control station when activated. An optional SX-3103 interface module may be added to allow hardwired inputs of normally open (open circuit) contact devices directly into these zones.

**NOTE: The SX-3103 accepts non-supervised open circuit device inputs only and is not designed for use in connecting a fire (ff) warning system detector.**

- **ACTIVATING CONTROL STATION AUXILIARY "A" (Fire ff)**

Press keys 1 and 7 simultaneously and hold for three seconds to activate. The bottom LED "Auxiliary" will light and the control station will begin beeping. The J-16, Pin 11 (+) 12 VDC output will activate for the duration of the Auxiliary "A" automatic cutoff time (factory default is no cutoff). The J-16, Pin 7 (+) 12 VDC output will activate until the alarm is reset from the control station by command 1 and a User Authorization code. The control station beeping may be silenced by pressing the " \* " key. If desired, the activation of control station Auxiliary "A" may be disabled by programming Function 266.

- **ACTIVATING CONTROL STATION AUXILIARY "B" (Police)**

Press keys 1 and 3 or " \* " and " # " simultaneously and hold for three seconds to activate. The fifth LED from the top "Interior Off" will blink and the control station will begin beeping. The J-16, Pin 10 (+) 12 VDC output will activate for the duration of the Auxiliary "B" automatic cutoff time. The J-16, Pin 7 (+) 12 VDC output will activate until the alarm is reset from the control station by command 1 and a User Authorization code. Auxiliary "B" may be programmed to be visually and audibly "silent" at the control station. If desired, the activation of control station Auxiliary "B" may be disabled by programming Function 267.

- **ACTIVATING CONTROL STATION AUXILIARY "C" (Emergency)**

Press keys 3 and 9 simultaneously and hold for three seconds to activate. The seventh LED "Delay Off" will blink and the control station will begin beeping once per second. Once the keys have been released, the J-16, Pin 9 (+) 12 VDC output will activate for the duration of the Auxiliary "C" automatic cutoff time. The J-16, Pin 7 (+) 12 VDC output will activate until the alarm is reset from the control station by command 1 and a User Authorization code. The control station beeping may be silenced by pressing the " \* " key. If desired, the activation of control station Auxiliary "C" may be disabled by programming Function 268.

## 6. PROGRAMMING THE CONTROL

All programming is stored in nonvolatile "EEPROM" memory. The control is shipped with a factory (default) program already installed. All programming options are referred to as Functions. The Program Function Map is a list of all Functions complete with their factory default values. The control may be custom tailored to the requirements of the individual installation through Installer Level Programming. Certain functions are programmable through User Level Programming. Both levels of programming may be entered locally from any control station. The control may also be Uploaded or Downloaded remotely. See section 8 "SPECIAL FEATURES". The system can be returned to factory default at any time with a few easy steps. See "Restoring factory default settings".

- 1) **PROGRAM FUNCTIONS . . . .** All programming options are called Functions. Each contains a specific value, which serves as an instruction to the control. Programming changes are accomplished by entering new values into chosen functions. The allowable "range" of a value contained in each function varies according to the specific type and purpose. For instance, most of the timer related functions (entry/exit, alarm cutoff, etc.) deal with either seconds or minutes and have a range of 1-255. Functions that are associated with the digital communicator such as the account number, report codes, and telephone number have a range of 1-15. Many functions are questions requiring a simple yes or no response. Since the microprocessor accepts only numbers, answers to these type functions must be in the form of a "0" for No or a "1" for Yes. The Program Function Map and Programming Functions and Descriptions sections provide additional information about each function as well as the allowable range of values.
- 2) **TWO LEVELS OF PROGRAMMING . . . .** User Level programming allows access to the first 33 functions. Any of the first 32 functions may be restricted or locked out from user access by placing specific values into function 406-409. Installer Level programming allows access to all programming functions including the first 33.
- 3) **PROGRAMMING AUTHORIZATION CODE . . . .** To enter the programming mode, press command "9" followed by the Programming Authorization code. This code is factory default programmed as 98765 and may be easily changed at any time.
- 4) **INSTALLER LEVEL PROGRAM SWITCH . . . .** To reach the Installer Level of programming, the program switch "SW1" located on the left side of the main control board must first be pressed, followed by entry of the programming authorization code. **Note: If the program code is lost, the programming mode can be entered by turning off the power switch and holding down the Program Switch (SW1) while turning the power switch back on, then release the program switch.**
- 5) **THREE MINUTE PROGRAMMING TIMER . . . .** A three minute timer is started upon depression of the Installer Level program switch and upon control station entry into the programming mode. Three minutes after exiting the programming mode, or if no keys are pressed for a duration of three minutes while in the programming mode, the control will emit a two second error tone and the control will return to the normal operation mode.
- 6) **THE "#" (FIND) AND "\*" (STORE) KEYS . . . .** Two special keys will be used while in the programming mode. They are the "#" (FIND) and "\*" (STORE) keys. While in the programming mode, any program function may be accessed by pressing the desired function number using the numeric keys and then pressing the FIND key. This key also serves as a (NEXT) key. When pressed without first pressing any of the number keys, the "#" key will advance programming to the (NEXT) consecutive function.  
Example: Pressing 1 + 2 + 5 and then FIND jumps to program function 125 and displays its current value.

**1 + 2 + 5 + (FIND)**

After "finding" a program function, the value (data) which it contains will be displayed on the LEDs. The value may be changed by pressing the desired new value using the keys 0 - 9 and then pressing the STORE key. This key also serves as a (QUIT) key. When pressed without first pressing any of the number keys, the "\*" key will automatically exit the programming mode.

Example: Pressing 4 + 3 and then STORE changes the current program function value to a value of 43.

**4 + 3 + (STORE)**

**Note: If a SX-3100ST Security Terminal is used, the function number and value will be displayed on the LCD. The "Find", "Next", "Store", and "Quit" operations associated with the "#" and "\*" keys will be displayed as words on the bottom line of the display. A selection is made by pressing the soft feature key directly below the displayed word.**



- 7) **READING THE VALUE OF A FUNCTION.** . . . While in the programming mode the control stations display the value that is stored within each Function. Values are displayed in combinations of lighted LEDs on the control station. Each LED has a specific numeric value which is printed on the inner control station label. The value of a Function may be determined by adding the values represented by each lighted LED. Table 3 references the value of each LED as viewed from the front of the control station. The top LED represents LED number 1 and the bottom LED represents LED number 8. Table 3 also shows an example of how to read and interpret the value shown by lighted LEDs.

LED #	LIGHTED VALUE	EXAMPLE
1	1	● 1
2	2	
3	4	
4	8	● 8
5	16	● 16
6	32	
7	64	
8	128	
		<b>TOTAL = 25</b>

**TABLE 3 LED PROGRAMMING VALUES**

**EXAMPLE:** If LED # 1, 4, and 5 are lighted, then the value of the location being displayed = 25 (1 + 8 + 16 = 25).

- 8) **ZONE PLANNING GUIDE . . . .** Zones are programmed by selecting the desired zone type and definitions using the Zone Planning guide as a worksheet. Each definition has a specific numeric value. After all selections are made, the individual values are added together and the total equals the value that should be programmed into the Function for that zone.
- 9) **PROGRAM FUNCTION MAP . . . .** Provides a list of each Function, its factory default value, and a blank space to write in any changes that may be desired. The map may be removed from the book and left inside the control for future references.
- 10) **EXITING THE PROGRAMMING MODE . . . .** Pressing the " \* " key twice exits programming mode.

**11) USER LEVEL PROGRAMMING EXAMPLE**

- Press command "9" then the Program Authorization code (Factory default code = 98765). All LEDs will flash upon successful entry into the programming mode.
- Select the function number to be programmed from the Function Map. Only functions 1-33 are ever allowed from the User Level. In the space provided on the Function Map, write in the value to be programmed.
- Press the numeric keys corresponding to the desired Function and then press the " # " (FIND) key.
- Press the numeric keys corresponding to the new value to be programmed and press the " \* " (STORE) key

**NOTE:** When programming certain user Functions, the control will automatically STORE the new value after all required digits are entered. Programming mode exits immediately after a function is changed from the User Level.

**12) INSTALLER LEVEL PROGRAMMING EXAMPLE**

- Momentarily press the program switch (SW1), located on the left side of the control board. Press command "9" and the Program Authorization code (Factory default code = 98765). All LEDs will flash upon successful entry into the programming mode.
- Select the function number to be programmed from the Function Map.
- Press the number keys 0-9 corresponding to the desired Function and then press the " # " (FIND) key.
- Press the number keys 0-9 corresponding to the new value to be programmed and press the " \* " (STORE) key
- Read the value displayed on the control station LEDs for verification.
- Press "#" to proceed to the (NEXT) Function or press desired number keys and " # " to (FIND) another Function. If all Functions have been programmed, press the " \* " key twice to exit the programming mode.

# SX-3100LCD PROGRAM FUNCTION MAP

Factory Default Values For All Functions Are Shown Inside Brackets [ ]. Valid Entry Ranges Are Shown Inside { }.

## USER OR INSTALLER LEVEL PROGRAMMING FUNCTIONS (USER MAY BE LOCKED-OUT FROM ANY OR ALL)

User Authorization Codes.	001 CODE 1 [24500] _____	007 CODE 7 [FFFFF] _____	013 CODE 13 [FFFFF] _____
	002 CODE 2 [FFFFF] _____	008 CODE 8 [FFFFF] _____	014 CODE 14 [FFFFF] _____
Use any five digits {0-9}	003 CODE 3 [FFFFF] _____	009 CODE 9 [FFFFF] _____	015 CODE 15 [FFFFF] _____
	004 CODE 4 [FFFFF] _____	010 CODE 10 [FFFFF] _____	016 CODE 16 [FFFFF] _____
Digits may repeat "[F's]" indicate the code is deleted	005 CODE 5 [FFFFF] _____	011 CODE 11 [FFFFF] _____	017 CODE 17 [FFFFF] _____
	006 CODE 6 [FFFFF] _____	012 CODE 12 [FFFFF] _____	
	018 USER PROGRAM AUTHORIZATION CODE [98765] _____ - Program five digits for maximum security.		

Counters, Timers and Special Use Functions	019 USAGE COUNT CODE 17 [255] _____ {1-254, 255=permanent}	028 BURG CUTOFF TIME IN MIN. [10] _____**	
	020 TIME UNTIL NEXT COMMUNICATOR TEST {0-24}	029 AUXILIARY "A" CUTOFF " " [255] _____**	
	021 CLEAR ALARM MEMORY {no value required}	030 AUXILIARY "B" CUTOFF " " [10] _____**	
	022 DELETE CODES {00-17, 00 will delete the installer code}	031 AUXILIARY "C" CUTOFF " " [10] _____**	
	023 ENTRANCE 1 TIME IN SEC. [30] _____ {1-255}	** {1-254, 0 or 255 = Never cutoff}	
	024 ENTRANCE 2 TIME IN SEC. [46] _____ {1-255}	032 TIME BETWEEN COMM. TESTS [1] _____	
	025 EXIT TIME IN SECONDS [60] _____ {1-255}	{0-7, 0 = 12 hours, 1-7 = 1 to 7 days}	
	026 ACCESS TIME IN SECONDS [5] _____ {0-255, 0 = LATCH}	033 BEGIN UPLOAD DATA {no value required}	
	027 DELAY BURG OUTPUT IN SEC. [0] _____ {0-255}		

### Installer Level Programming ONLY Beyond This Point

Configuration	034 CODE 1 [3] _____	039 CODE 6 [3] _____	044 CODE 11 [3] _____	049 CODE 16 [3] _____
Digits for User Codes 1 - 17 {0-15}	035 CODE 2 [3] _____	040 CODE 7 [3] _____	045 CODE 12 [3] _____	050 CODE 17 [3] _____
Refer to Table 4	036 CODE 3 [3] _____	041 CODE 8 [3] _____	046 CODE 13 [3] _____	
	037 CODE 4 [3] _____	042 CODE 9 [3] _____	047 CODE 14 [3] _____	
	038 CODE 5 [3] _____	043 CODE 10 [3] _____	048 CODE 15 [3] _____	

Zone Definitions {1-255}	051 ZONE 1 [64] _____	055 ZONE 5 [65] _____	059 ZONE 9 [65] _____	063 ZONE 13 [65] _____
	052 ZONE 2 [72] _____	056 ZONE 6 [65] _____	060 ZONE 10 [65] _____	064 ZONE 14 [65] _____
Refer to the Zone Planning Guide	053 ZONE 3 [81] _____	057 ZONE 7 [65] _____	061 ZONE 11 [65] _____	065 ZONE 15 [65] _____
	054 ZONE 4 [65] _____	058 ZONE 8 [66] _____	062 ZONE 12 [65] _____	066 ZONE 16 [65] _____

Digital Communicator Setup	067 COMMUNICATOR DISABLE/DELAY IN SECONDS [0] _____ {0-255, 0 disables communicator}		
	068 DIAL ATTEMPTS BEFORE SHUTDOWN TELEPHONE 1 [8] _____ {1-255} <i>Note: Odd value (1, 3, etc) will disable</i>		
	069 DIAL ATTEMPTS BEFORE SHUTDOWN TELEPHONE 2 [8] _____ {1-255} <i>the fail to-communicate warning.</i>		
	070 FOR FUTURE USE		
	071 FOR FUTURE USE		
	072 LINE SEIZURE HANGUP TIME IN SECONDS [3] _____ {0-255}		
	073 TIME BETWEEN DIAL ATTEMPTS IN SECONDS [10] _____ {0-255}		
	074 ABORT COMMUNICATOR UPON DISARMING [0] _____ {0=N 1=Y}		
	075 DISABLE DIALER TEST ON POWER- UP [0] _____ {0=N 1=Y}		
	076 EXCEPTION OPENING/SYSTEM RESTORE [0] _____ {0=N 1=Y}		

Account Number Telephone 1 {0-15}	077 DIGIT 1 [0] _____ (See note)	078 DIGIT 2 [8] _____	079 DIGIT 3 [8] _____	080 DIGIT 4 [8] _____
	<i>Note: Digit 1 MUST ALWAYS be "0" unless 4/2 format is enabled (Function 83). A "0" signifies no digit. To report the number "0", a "10" must be programmed. Some receivers translate numbers 10, 11, 12, 13, 14, 15 to hexadecimal characters A, B, C, D, E, F respectively.</i>			

Reporting Formats	081 TRANSMISSION FORMAT	[0] ___ {0-7}	085 EXTENDED SINGLE LINE	[0] ___ {0=N 1=Y}
Telephone 1	082 SINGLE ROUND REPORT	[0] ___ {0=N 1=Y}	086 PARITY CHECKSUM	[0] ___ {0=N 1=Y}
{0 - 7}	083 4/2 TRANSMISSION FORMAT	[0] ___ {0=N 1=Y}	087 TOUCHTONE DIALING	[0] ___ {0=N 1=Y}
	084 EXTENDED STANDARD	[0] ___ {0=N 1=Y}		

Reporting Codes	088 ZONE 01 [3] ___	096 ZONE 09 [6] ___	104 KP AUXILIARY A [1] ___	112 ZONE RESTORE	[0] ___
Telephone 1	089 ZONE 02 [3] ___	097 ZONE 10 [6] ___	105 KP AUXILIARY B [2] ___	113 SUPERVISORY/TBL	[0] ___
{Range 0-15}	090 ZONE 03 [3] ___	098 ZONE 11 [6] ___	106 KP AUXILIARY C [0] ___	114 LOW BATTERY	[0] ___
	091 ZONE 04 [3] ___	099 ZONE 12 [6] ___	107 DURESS	[0] ___	115 BATTERY RESTORE [0] ___
	092 ZONE 05 [3] ___	100 ZONE 13 [6] ___	108 OPENING	[0] ___	116 AC FAILURE [0] ___
	093 ZONE 06 [3] ___	101 ZONE 14 [6] ___	109 CLOSING	[0] ___	117 AC RESTORE [0] ___
	094 ZONE 07 [3] ___	102 ZONE 15 [6] ___	110 SHUNTED ZONE	[0] ___	118 MEMORY ERROR [0] ___
	095 ZONE 08 [1] ___	103 ZONE 16 [6] ___	111 CANCEL	[0] ___	119 AUTO TEST [0] ___

Number To Dial	_____												
Telephone 1	120 D1	121 D2	122 D3	123 D4	124 D5	125 D6	126 D7	127 D8	128 D9	129 D10	130 D11	131 D12	132 D13
{0 - 15}	_____												
Defaults are [15]	133 D14	134 D15	135 D16	136 D17	137 D18	138 D19	139 D20	140 D21	141 D22	142 D23	143 D24	144 D25	145 D26
	<i>Note: A 0 or 10 = dialing number "0", 11 &amp; 12 = touchtone "*" &amp; "#", 13 = three second dialing pause, 14 = additional wait for dial tone, 15 = end of dialing and MUST be programmed after the last valid number.</i>												

Special Functions	146 AUDIO LISTEN-IN CAPABILITY TELEPHONE 1	[0] ___ {0=N 1=Y}
	147 EXITS TO PROGRAMMING ENTRY MODE	
	148 COPY TEL 1 ACCOUNT, FORMAT AND REPORT CODES TO TEL 2	{no value required}
	149 COPY TEL 1 DIALED NUMBER TO TEL 2	{no value required}

Account Number	150 DIGIT 1 [0] ___ (See note)	151 DIGIT 2 [8] ___	152 DIGIT 3 [8] ___	153 DIGIT 4 [8] ___
Telephone 2	<i>Note: Digit 1 MUST ALWAYS be "0" unless 4/2 format is enabled (Function 156). A "0" signifies no digit. To report the number "0", a "10" must be programmed. Some receivers translate numbers 10,11,12,13,14,15 to hexadecimal characters A,B,C,D,E,F respectively.</i>			
{0-15}	_____			

Reporting Formats	154 TRANSMISSION FORMAT	[0] ___ {0-7}	158 EXTENDED SINGLE LINE	[0] ___ {0=N 1=Y}
Telephone 2	155 SINGLE ROUND REPORT	[0] ___ {0=N 1=Y}	159 PARITY CHECKSUM	[0] ___ {0=N 1=Y}
	156 4/2 TRANSMISSION FORMAT	[0] ___ {0=N 1=Y}	160 TOUCHTONE DIALING	[0] ___ {0=N 1=Y}
	157 EXTENDED STANDARD	[0] ___ {0=N 1=Y}		

Reporting Codes	161 ZONE 01 [3] ___	169 ZONE 09 [6] ___	177 KP AUXILIARY A [1] ___	185 ZONE RESTORE	[0] ___
Telephone 2	162 ZONE 02 [3] ___	170 ZONE 10 [6] ___	178 KP AUXILIARY B [2] ___	186 SUPERVISORY/TBL	[0] ___
{Range 0-15}	163 ZONE 03 [3] ___	171 ZONE 11 [6] ___	179 KP AUXILIARY C [0] ___	187 LOW BATTERY	[0] ___
	164 ZONE 04 [3] ___	172 ZONE 12 [6] ___	180 DURESS	[0] ___	188 BATTERY RESTORE [0] ___
	165 ZONE 05 [3] ___	173 ZONE 13 [6] ___	181 OPENING	[0] ___	189 AC FAILURE [0] ___
	166 ZONE 06 [3] ___	174 ZONE 14 [6] ___	182 CLOSING	[0] ___	190 AC RESTORE [0] ___
	167 ZONE 07 [3] ___	175 ZONE 15 [6] ___	183 SHUNTED ZONE	[0] ___	191 MEMORY ERROR [0] ___
	168 ZONE 08 [1] ___	176 ZONE 16 [6] ___	184 CANCEL	[0] ___	192 AUTO TEST [0] ___

Number To Dial	_____												
Telephone 2	193 D1	194 D2	195 D3	196 D4	197 D5	198 D6	199 D7	200 D8	201 D9	202 D10	203 D11	204 D12	205 D13
{0 - 15}	_____												
Defaults are [15]	206 D14	207 D15	208 D16	209 D17	210 D18	211 D19	212 D20	213 D21	214 D22	215 D23	216 D24	217 D25	218 D26
	<i>Note: A 0 or 10 = dialing number "0", 11 &amp; 12 = touchtone "*" &amp; "#", 13 = three second dialing pause, 14 = additional wait for dial tone, 15 = end of dialing and MUST be programmed after the last valid number.</i>												

Special Functions	219 AUDIO LISTEN-IN CAPABILITY TELEPHONE 2 [0] ____ {0=N 1=Y}												
	220 NUMBER OF RINGS UNTIL COMMUNICATOR AUTOMATICALLY ANSWERS [0] ____ {0-15}												
Upload/Download													
Callback Phone	221 D1	222 D2	223 D3	224 D4	225 D5	226 D6	227 D7	228 D8	229 D9	230 D10	231 D11	232 D12	233 D13
Number To Dial													
{0 - 15}	234 D14	235 D15	236 D16	237 D17	238 D18	239 D19	240 D20	241 D21	242 D22	243 D23	244 D24	245 D25	246 D26
Defaults are [15]	Note: A 0 or 10 = dialing number "0", 11 & 12 = touchtone "*" & "#", 13 = three second dialing pause, 14 = additional wait for dial tone, 15 = end of dialing and MUST be programmed after the last valid number.												
Control Options	247 SX-3104 EIGHT ZONE EXPANDER ENABLED [0] ____						256 KEYSWITCH MODE CHANGE [0] ____						
All except # 252	248 TWO DIGIT ARMING [0] ____						257 SUPERVISORY ALERT LATCH [0] ____						
and #264 are Yes	249 ENABLE FORCE ARMING [0] ____						258 AUTOMATIC INTERIOR OFF [0] ____						
No format	250 PERMANENT FORCE ARM (SHUNT) [0] ____						259 AUTOMATIC DELAY OFF [0] ____						
{0=No, 1=Yes}	251 DELAY BURGLAR RESTORE UNTIL CUTOFF [0] ____						260 DISABLE INTERIOR FOLLOWER [0] ____						
	252 BURGLAR ALARM REPORTS UNTIL LOCKOUT [0] ____ *						261 SIREN/BELL TEST UPON ARMING [0] ____						
	* {0-15, 0=No Communicator lockout}						262 SLAVE MODE OPERATION [0] ____						
	253 PULSING BURGLAR J-16, PIN 12 [0] ____						263 RESET TEST TIMER ON KISSOFF [0] ____						
	254 PULSING AUXILIARY "A" J-16, PIN 11 [0] ____						264 INTERIOR/DELAY DISARM DEFAULT [0] ____						
	255 BURGLAR LOOP AUDIBLE LOCKOUT [0] ____												
Control Station	265 COMMANDS 4 & 5 WORK IF ARMED [0] ____						272 DISABLE KEYPAD COMMAND 6 [0] ____						
Options	266 DISABLE KEYPAD AUXILIARY "A" [0] ____						273 DISABLE KEYPAD COMMAND 7 [0] ____						
Yes or No Format	267 DISABLE KEYPAD AUXILIARY "B" [0] ____						274 DISABLE KEYPAD COMMAND 8 [0] ____						
{0=No, 1=Yes}	268 DISABLE KEYPAD AUXILIARY "C" [0] ____						275 SILENT KEYPAD ON BURGLAR [0] ____						
	269 DISABLE KEYPAD SHUNTING [0] ____						276 SILENT KEYPAD/ NO LED BLINK ON AUX. "B" [0] ____						
	270 DISABLE KEYPAD COMMAND 4 [0] ____						277 START ENTRANCE DELAY ONE [0] ____						
	271 DISABLE KEYPAD COMMAND 5 [0] ____												
Zone Supervisory/	278 ZONE 1 [0] ____			282 ZONE 5 [0] ____			286 ZONE 9 [0] ____			290 ZONE 13 [0] ____			
Trouble upon:	279 ZONE 2 [0] ____			283 ZONE 6 [0] ____			287 ZONE 10 [0] ____			291 ZONE 14 [0] ____			
{0=OPEN }	280 ZONE 3 [0] ____			284 ZONE 7 [0] ____			288 ZONE 11 [0] ____			292 ZONE 15 [0] ____			
{1=SHORT}	281 ZONE 4 [0] ____			285 ZONE 8 [0] ____			289 ZONE 12 [0] ____			293 ZONE 16 [0] ____			
Extended Report	294 CODE 1 [1] ____			299 CODE 6 [ 6 ] ____			304 CODE 11 [11] ____			309 CODE 16 [15] ____			
Digits For User	295 CODE 2 [2] ____			300 CODE 7 [ 7 ] ____			305 CODE 12 [12] ____			310 CODE 17 [15] ____			
Codes 1 - 17	296 CODE 3 [3] ____			301 CODE 8 [ 8 ] ____			306 CODE 13 [13] ____			311 KEY ** [15] ____			
{0-15}	297 CODE 4 [4] ____			302 CODE 9 [ 9 ] ____			307 CODE 14 [14] ____			** Arming/disarming using a keyswitch			
	298 CODE 5 [5] ____			303 CODE 10 [10] ____			308 CODE 15 [15] ____						
Extended Report	312 ZONE 1 [1] ____			316 ZONE 5 [5] ____			320 ZONE 9 [ 9 ] ____			324 ZONE 13 [13] ____			
Digits For Zone	313 ZONE 2 [2] ____			317 ZONE 6 [6] ____			321 ZONE 10 [10] ____			325 ZONE 14 [14] ____			
Alarms	314 ZONE 3 [3] ____			318 ZONE 7 [7] ____			322 ZONE 11 [11] ____			326 ZONE 15 [15] ____			
{0-15}	315 ZONE 4 [4] ____			319 ZONE 8 [8] ____			323 ZONE 12 [12] ____			327 ZONE 16 [15] ____			
Extended Report	328 ZONE 1 [1] ____			332 ZONE 5 [5] ____			336 ZONE 9 [ 9 ] ____			340 ZONE 13 [13] ____			
Digits For Zone	329 ZONE 2 [2] ____			333 ZONE 6 [6] ____			337 ZONE 10 [10] ____			341 ZONE 14 [14] ____			
Restorals	330 ZONE 3 [3] ____			334 ZONE 7 [7] ____			338 ZONE 11 [11] ____			342 ZONE 15 [15] ____			
{0-15}	331 ZONE 4 [4] ____			335 ZONE 8 [8] ____			339 ZONE 12 [12] ____			343 ZONE 16 [15] ____			

Extended Report	344 ZONE 1 [1] ____	348 ZONE 5 [5] ____	352 ZONE 9 [9] ____	356 ZONE 13 [13] ____
Digits For Zone	345 ZONE 2 [2] ____	349 ZONE 6 [6] ____	353 ZONE 10 [10] ____	357 ZONE 14 [14] ____
Shunts	346 ZONE 3 [3] ____	350 ZONE 7 [7] ____	354 ZONE 11 [11] ____	358 ZONE 15 [15] ____
{0-15}	347 ZONE 4 [4] ____	351 ZONE 8 [8] ____	355 ZONE 12 [12] ____	359 ZONE 16 [15] ____

Extended Report	360 ZONE 1 [1] ____	364 ZONE 5 [5] ____	368 ZONE 9 [9] ____	372 ZONE 13 [13] ____
Digits for Zone	361 ZONE 2 [2] ____	365 ZONE 6 [6] ____	369 ZONE 10 [10] ____	373 ZONE 14 [14] ____
Supervisory/Tbls	362 ZONE 3 [3] ____	366 ZONE 7 [7] ____	370 ZONE 11 [11] ____	374 ZONE 15 [15] ____
{0-15}	363 ZONE 4 [4] ____	367 ZONE 8 [8] ____	371 ZONE 12 [12] ____	375 ZONE 16 [15] ____

Miscellaneous	376 EXTENDED AC CODE [10] ____	380 EXTENDED KEYPAD "A" CODE [9] ____
Extended Report	377 EXTENDED BATTERY CODE [9] ____	381 EXTENDED KEYPAD "B" CODE [9] ____
Digits	378 EXTENDED PARITY CODE [15] ____	382 EXTENDED KEYPAD "C" CODE [9] ____
{0-15}	379 EXTENDED TEST CODE [9] ____	383 EXTENDED MISSING KEYPAD CODE [15] ____

384 to 401 EXITS TO PROGRAMMING MODE - RESERVED FOR FUTURE USE

Loop Response	402 FAST LOOP RESPONSE TIME x 40 milliseconds [2] ____ {1-255}
Timers	403 SLOW LOOP RESPONSE TIME x 40 milliseconds [8] ____ {1-255}

Special Purpose	404 EXITS TO PROGRAMMING ENTRY MODE	410 INSTALLER PROGRAM CODE ____ [F's]
	405 RESTORE FACTORY DEFAULTS [0] ____ {0-1}	411 INTERNAL CLOCK ADJUST [50]
	406 LOCKOUT USER FUNCTIONS 1-8 [0] ____ §	412 SYSTEM TEST FOR FACTORY
	407 LOCKOUT USER FUNCTIONS 9-16 [0] ____ §	413 TOUCHTONE TEST GENERATION
	408 LOCKOUT USER FUNCTIONS 17-24 [192] ____ §	414 FACTORY ID
	409 LOCKOUT USER FUNCTIONS 25-32 [255] ____ §	<b>Do not program. Consult Factory</b>

§ To lock-out User level access of Functions 1 to 32, select Functions to be locked-out and enter value into selection column. Add the values in the selection column to obtain a total. Enter total into the appropriated Functions (406-407) as indicated.

FUNCTION	VALUE	SELECTION
001 USER CODE 1	1	
002 USER CODE 2	2	
003 USER CODE 3	4	
004 USER CODE 4	8	
005 USER CODE 5	16	
006 USER CODE 6	32	
007 USER CODE 7	64	
008 USER CODE 8	128	
FUNCTION 406 TOTAL VALUE = [0]		

LOCKOUT USER FUNCTIONS 001 - 008

FUNCTION	VALUE	SELECTION
017 USER CODE 17	1	
018 USER PROGRAM CODE	2	
019 USAGE COUNT CODE 17	4	
020 TIME TILL NEXT TEST	8	
021 CLEAR ALARM MEMORY	16	
022 DELETE CODES	32	
023 ENTRANCE DELAY 1	64	[64]
024 ENTRANCE DELAY 2	128	[128]
FUNCTION 408 TOTAL VALUE = [192]		

LOCKOUT USER FUNCTIONS 017 - 024

FUNCTION	VALUE	SELECTION
009 USER CODE 9	1	
010 USER CODE 10	2	
011 USER CODE 11	4	
012 USER CODE 12	8	
013 USER CODE 13	16	
014 USER CODE 14	32	
015 USER CODE 15	64	
016 USER CODE 16	128	
FUNCTION 407 TOTAL VALUE = [0]		

LOCKOUT USER FUNCTIONS 009 - 016

FUNCTION	VALUE	SELECTION
025 EXIT DELAY TIME	1	[1]
026 ACCESS ON TIME	2	[2]
027 DELAY BURGLAR OUTPUT	4	[4]
028 BURGLAR CUTOFF TIME	8	[8]
029 AUX. "A" (FIRE ff) CUTOFF	16	[16]
030 AUX. "B" (POLICE) CUTOFF	32	[32]
031 AUX. "C" (EMER) CUTOFF	64	[64]
032 TIME BETWEEN TEST	128	[128]
FUNCTION 409 TOTAL VALUE = [255]		

LOCKOUT USER FUNCTIONS 025 - 032

## 7. PROGRAMMING FUNCTIONS AND DESCRIPTIONS

Each programming Function is assigned a number from 1 to 414. These correspond directly to the numbers listed on the Function Map. A description of each Function is provided in this section. Select those that are to be programmed, and write the values to be programmed onto the Function map. The pre-programmed (factory default) values are indicated in brackets [ ] on the Function map. If a Function is to be left at its default value, no programming will be required.

**NOTE:** Functions 1 to 33 may be programmed from either the User or Installer Level programming mode. If desired, each individual Function may be "locked-out" from User level access. Functions 34 to 414 can ONLY be accessed by the Installer Level and requires that the program switch SW1 (see Figure 18) be momentarily pressed along with entering the program authorization code. A special Installer Program code (Function 410) may be programmed which will eliminate the need to repeatedly press switch SW1 during initial installation. The 24 hr. battery test will disable this code automatically.

### RESTORING THE FACTORY DEFAULT SETTINGS

The control may be returned to the factory default settings at any time. Restoring the factory defaults automatically resets all installer level and user level program Functions to the original default (factory pre-programmed) settings. This provides a quick means of erasing any bench testing programming prior to final installation. Refer to the Function Map for a complete listing of the default settings.

1. Press the program switch SW1 (see Figure 18).
2. Press command "9" followed by the Program Authorization code. If this code is unknown, proceed to the alternate method below.
3. The control station LEDs will flash indicating entry into the programming mode.
4. Enter Function 405 and press the " # " (FIND) key.
5. Enter a value of "1" and press the " \* " (STORE) key. The first or top LED should now be lighted.
6. Press the " \* " (STORE) key twice to exit the programming mode. There will be a 5 - 10 second delay while the control restores the factory defaults. During this time the control will not respond to other commands. After approximately 5 - 10 seconds, the factory defaults will be restored and the control will return to normal operation.

### ALTERNATE METHOD

This method may be used whenever the Program Authorization code is unknown or non-functional.

1. Turn the master power switch to "OFF" (down).
2. Depress and hold the program switch SW1 (see Figure 18) while turning the master power switch to "ON" (up).
3. The control station LEDs will flash indicating programming mode entry. Release the program switch.
4. Enter function number 405 and press the " # " (FIND) key.
5. Enter a value of "1" and press the " \* " (STORE) key. The first or top LED should now be lighted.
6. Press the " \* " (STORE) key twice to exit the programming mode. There will be a 5 - 10 second delay while the control restores the factory defaults. During this time the control will not respond to other commands. After approximately 5 - 10 seconds, the factory defaults will be restored and the control will return to normal operation.

### **1-16 - USER AUTHORIZATION CODES 1 - 16**

Each user authorization codes must be assigned a specific security level to perform commands such as arm/disarm, activate access output, etc. The capability of each code is determined by a configuration digit (function 34 - 50). Codes may be of 1 - 5 digits in length in any combination (U.L. requires a code to be minimum of 4 digits in length). If a code of less than 5 digits is desired, program the unused spaces after the code with trailing zeros (0). These zeros will not become a part of the actual code, therefore no code can end in zero. Function 22 may be used to delete any user code. User authorization code 17 performs the same function as user codes 1 - 16 except that the number of times that it can be used is controlled by function 19. After the usage count expires, the code becomes inactive until a new usage count value is programmed into function 19. Code 17 may also be programmed as permanently active by selecting a value of 255 for Function 19.

### **18 - PROGRAM AUTHORIZATION CODE**

The program authorization code is used to gain entry into the programming mode. This code may be of 1 - 5 digits in length (U.L. requires a code to be minimum of 4 digits in length). For maximum security against unauthorized programming changes, a code of five digits is suggested. This code is programmed in the same manner as the user authorization codes. **Note: If two digit arming (Function 248) is enabled, and the first digit of any user code is the same as the first digit of the program code, the programming code will no longer allow entry into the programming mode. If this occurs, the only way to access the programming mode will be to: 1. Turn the master power switch OFF. 2. Hold down the program switch SW1 while turning the power switch ON. The control will then power-up into the programming mode. If desired, the program authorization code may then be changed by pressing 1 8 (Function 18) followed by the "#" (FIND) key. Select and enter a new program code with a different first digit and press "\*" (STORE) to exit the programming mode.**

### **19 - USAGE COUNT CODE 17**

A value programmed into this location represents the number of times that user authorization code 17 may be used. After the code is used for the programmed number of times code 17 becomes inactive until a new usage count value is programmed. A value of 255 will make user code 17 permanent.

### **20 - TIME UNTIL THE NEXT COMMUNICATOR TEST REPORT**

This Function is used to select the time until the next automatic communicator test is reported to the central station. A report code must be programmed (functions 119 & 192) in order for the communicator test to occur. The test report, if enabled, will be reported after the selected time expires and then routinely every 12 hours, or 1 to 7 days as specified by function 32. **Note: This Function only alters the communicator test time. The automatic battery load test is conducted every 24 hours beginning with initial power-up.**

### **21 - CLEAR ALARM MEMORY**

Entering this Function will automatically clear alarm memory. No value is required or may be programmed for this location.

### **22 - DELETE CODES**

Entering this function followed by pressing the numeric keys (01 to 17) corresponding to a user authorization code, deletes the corresponding user code. Entering "00" deletes the installer program code (function 410).

### **23 - ENTRANCE DELAY #1 TIME**

Allowable time in seconds for entering an "entry delay 1" defined zone and disarming the system without causing an alarm condition. Valid range is 1 to 255 seconds. Default is 30. **U.L. allows a maximum of 45 seconds.**

### **24 - ENTRANCE DELAY #2 TIME**

Allowable time in seconds for entering an "entry delay 2" defined zone and disarming the system without causing an alarm condition. Valid range is 1 to 255 seconds. Default is 46. **U.L. allows a maximum of 45 seconds.**

### **25 - EXIT DELAY TIME**

Allowable time in seconds for exiting through an interior or delay defined zone without causing an alarm. Valid range is 1-255 seconds. Default is 60. **U.L. allows a maximum of 60 seconds.**

**26 - ACCESS ON TIME** Amount of time in seconds that the Access output (J-16 pin 3) will be active when an access authorization code is entered. Valid range is 1 to 255 seconds. Default is 5. This output acts as a momentary switch but may be set as latching by programming a value of "0".

**27 - DELAY BURGLAR ALARM OUTPUT** Time in seconds that may be programmed to delay activation of burglar output (J-16 pin 12) upon activation of the burglar alarm. Valid range is 0 to 255 seconds. Default is 0 seconds. **U.L. allows a combined total entrance delay, and a delay before burglar alarm output time of 45 seconds.**

### **28 - BURGLAR ALARM CUTOFF TIME**

Time in minutes that Burglar output (J-16 pin 12) will be active before automatic cutoff. A value of "0" or "255" eliminates automatic cutoff. Valid range is 0 to 255 minutes. Default is 10 minutes. **U.L. requires a minimum burglar alarm time of 4 minutes for household and allows a maximum of 15 minutes for local burglar alarm applications.**

### **29 - AUXILIARY "A" (FIRE ff) CUT-OFF TIME**

Time in minutes that Auxiliary "A" (fire ff) output (J-16 pin 11) will be active before automatic cutoff. A value of "0" or "255" eliminates automatic cut-off. Valid range is 0 to 255 minutes. Default is 0 minutes. **U.L. allows no automatic cutoff.**

### **30 - AUXILIARY "B" (POLICE) CUTOFF TIME**

Time in minutes that Auxiliary "B" (police) output (J-16 pin 10) will be active before automatic cutoff. A value of "0" or "255" eliminates automatic cutoff. Valid range is 0 to 255 minutes. Default is 10 minutes.

### **31 - AUXILIARY "C" (EMERGENCY) CUTOFF TIME**

Time in minutes that Auxiliary "C" output (J-16 pin 9) will be active before automatic cutoff. A value of "0" or "255" eliminates automatic cutoff. Valid range is 0 to 255 minutes. Default is 10 minutes.

### **32 - TIME BETWEEN COMMUNICATOR TESTS**

This function specifies the time between each automatic communicator test report. This report may be programmed for every 12 hours or from 1 to 7 days. **U.L. requires an automatic test to be performed at least once every 24 hours on commercial installations.**

### **33 - UPLOAD DATA TO A REMOTE LOCATION**

This function is used to perform a complete EEPROM memory upload to a remote location IBM PC ® or compatible computer over ordinary telephone lines. This function requires the installation of a computer with special software to receive the data. Telephone contact must be made before function 33 is activated. When this function is activated, the telephone line is seized and the data is uploaded. Transmission of data can be interrupted by depressing the "\*" key for five seconds or until the system releases the telephone line. See SPECIAL FEATURES, REMOTE PROGRAMMING for details.

**INSTALLER LEVEL PROGRAMMING ONLY BEYOND THIS POINT**



### 34 - 50 - CONFIGURATION DIGITS FOR CODES 1 - 17

Each user authorization code is assigned a security level called a "Configuration Digit" (programming function 34 through 50) which defines the operations that the code is authorized to perform. Select the appropriate configuration digit for each code desired and enter the values into the function map. Table 4 describes the configuration digits and describes the usage allowed by each. See SUBZONING under the SPECIAL FEATURES section for information about configuration digits 8, 10, 11, 12, 13, 14, and 15.

DIGIT	DESCRIPTION
0	Used to allow "single digit commands" from a control station. First program a user authorization code with all zeros (00000) then assign that code with "0" configuration digit. This allows all commands except ARM/DISARM and ACCESS to be operated by pressing only the command key.
1	Arm/Disarm (command 1).
2	Activate J-16 pin 3 access output (command 0).
3	Arm/Disarm(command 1) or activate J-16 pin 3 access output(command 0).
4	Master Arm/Disarm. When the control is armed by a master code, only that code or another master code can disarm the control.
5	Arm/Disarm and activate J-16 pin 3 access output simultaneously upon entering arm command. Command 0 remains inactive.
6	Special Arm/Disarm. Same as configuration digit 1 with one exception. If the communicator is programmed for opening/closing reports, no report will transmit when this code is used to arm or disarm the control. <b>Warning: If the control is armed by another code and a closing report is sent, the central station WILL NOT receive an opening if the control is later disarmed by a code which has a configuration digit "6".</b>
7	Arm/Disarm and activate J-16 pin 3 access output simultaneously upon entering the arm command or may activate J-16 pin 3 access output by entering keypad command 0.
8	Arm/Disarm a dedicated subzone using arm command.
9	Arm/Disarm and transmit duress code to central station receiver simultaneously when entering arm command.
10	Arm/Disarm a dedicated subzone plus the next consecutive zone using arm command.
11	Arm/Disarm a dedicated subzone plus the next two consecutive zones using arm command.
12	Arm/Disarm a dedicated subzone plus the next three consecutive zones using arm command..
13	Arm/Disarm a dedicated subzone plus the next four consecutive zones using arm command.
14	Arm/Disarm a dedicated subzone plus the next five consecutive zones using arm command.
15	Arm/Disarm a dedicated subzone plus the next six consecutive zones using arm command.

**TABLE 4 CONFIGURATION DIGITS**

### 51 - 66 - ZONE 01-16 DEFINITION

These locations are used to define the 16 hardwired zones (Optional SX-3104 Zone Expansion Board required for zones 09-16). Refer to Table 5 Zone Planning Guide and select the desired zone types by entering values of selected zone options and sub-options into the spaces provided. Add the values assigned to each zone and enter the totals for each zone into functions 51 - 66.

1. Plan each zone individually.
2. Select ZONE TYPE from the left column. Each zone can have only one (1) zone type.
3. Choose the desired options and sub-options for the selected zone using the DEFINITION column.
4. Place the corresponding VALUE into the designated block for the zone being planned.
5. Add the values that were placed into the blocks for each planned zone. The total represents the DEFINITION of that particular zone.
6. Place the total for each zone in the bottom TOTAL VALUE block. The function number into which the total should be programmed is located beneath each block.
7. Program the TOTAL VALUE (definition) for each zone into the corresponding function number.

ZONE TYPE	DEFINITION	VALUE	ZONES															
			01	02	03	04	05	06	07	08	09	10	11	12	13	14	15	16
BURGLAR LOOPS	ENTRY DELAY 1	= 0																
	INSTANT	= 1																
	SILENT INSTANT	= 7																
	ENTRY DELAY 2	= 8																
	INTERIOR	= 16																
	NON-SHUNTABLE	= 32																
	SLOW RESPONSE	= 64																
SUPERVISORY/TBL	=128																	
AUXILIARY "A" ( <i>ff</i> FIRE)	= 2																	
SHUNTABLE ††	= 32																	
SLOW RESPONSE	= 64																	
AUXILIARY "B" (POLICE)	= 3																	
NO AUXILIARY "B" J-16, PIN 10 OUTPUT	= 8																	
NO VIOLATION J-16, PIN 7 OUTPUT	= 16																	
SHUNTABLE	= 32																	
SLOW RESPONSE	= 64																	
SUPERVISORY/TBL	= 128																	
AUXILIARY "C" (EMERGENCY)	= 4																	
SHUNTABLE ††	= 32																	
SLOW RESPONSE	= 64																	
SUPERVISORY/TBL	= 128																	
KEYSWITCH	= 5																	
MAINTAINED TYPE	= 16																	
SHUNTABLE	= 32																	
SUPERVISORY/TBL	= 128																	
COMMUNICATOR REPORT ONLY	= 6																	
SHUNTABLE	= 32																	
SLOW RESPONSE	= 64																	
SUPERVISORY/TBL	= 128																	
TOTAL VALUE FOR SELECTED ZONE TYPE =																		
FUNCTION # FOR ENTERING VALUE TOTAL		051	052	053	054	055	056	057	058	059	060	061	062	063	064	065	066	

TABLE 5 ZONE PLANNING GUIDE

†† U.L. Does not permit this zone to be programmed as shuntable

#### **67 - COMMUNICATOR DISABLE AND DELAY**

This function is used to activate or deactivate the communicator. If a value of "0" is entered the communicator will remain inactive. Any value of 1 to 255 will allow the communicator to enable after a delay of the same number in seconds. **U.L. requires that the communicator be enabled for either Local or Police Station Connected Burglar Alarm installations.**

#### **68 - DIAL ATTEMPTS BEFORE SHUTDOWN (TELEPHONE NUMBER 1)**

This function sets the number of times that the communicator will attempt to dial the central station receiver using telephone number 1 before automatically shutting down if unsuccessful. Valid range is 1-255. If the communicator is unsuccessful, the control stations will begin beeping and light the "Fail to Communicate" LED indicator. The fail to communicate warning may be totally disabled for either telephone numbers by programming an odd value (1,3, etc.) for the dial attempts. When function 68 is programmed, the selected value is duplicated into function 69 automatically. Function 69 must be programmed separately if a different value is desired. **NOTE: U.L. requires 5 dial attempts minimum, 10 dial attempts maximum. DO NOT PROGRAM WITH A VALUE OF "0".**

#### **69 - DIAL ATTEMPTS BEFORE SHUTDOWN (TELEPHONE NUMBER 2)**

This function sets the number of times that the communicator will attempt to dial the central station receiver using telephone number 2 before automatically shutting down if unsuccessful. Valid range is 1-255. See function 68 for additional information. **NOTE: U.L. requires 5 dial attempts minimum, 10 dial attempts maximum. DO NOT PROGRAM WITH A VALUE OF "0".**

#### **70 - FOR FUTURE USE**

#### **71 - FOR FUTURE USE**

#### **72 - LINE SEIZURE HANG UP TIME**

Communicator hang up time in seconds if no dial tone is detected. Valid range is 1-255.

#### **73 - TIME BETWEEN DIAL ATTEMPTS**

Time in seconds between dial attempts if subsequent dial attempt was unsuccessful. Valid range is 1-255. **U.L. requires no more than 45 seconds for U.L. certified accounts.**

#### **74 - ABORT COMMUNICATOR UPON DISARMING**

A value of "1" in this location will abort the communicator transmission upon entry of the arm/disarm code. A cancel report code can be sent upon abort by programming function 111 and 184.

#### **75 - DISABLE DIALER TEST ON POWER-UP**

If a test report code (function 119 and 192) is programmed, a value of "0" allows the communicator to dial the central station with a test report code whenever the system is powered-up or reset by the watchdog timer. A value of "1" disables this feature preventing a dialer test on power-up.

#### **76 - EXCEPTION OPENING/SYSTEM RESTORE**

A value of "1" causes the communicator to report the opening code (function 108 and 181) ONLY when the system has been disarmed (reset) after an alarm. A value of "0" disables Exception Opening/Restore reporting.

#### **77-80 - ACCOUNT NUMBER (TELEPHONE NUMBER 1)**

Functions 77 to 80 store the 3 or 4 digit account number. One digit of the account number is stored in a separate function beginning with function 77=digit 1, 78=digit 2, 79=digit 3, and 80=digit 4. Valid range is 0-15. A zero "0" signifies NO digit and must be programmed into function 77 if only a three digit account number is desired. A 10 must be programmed to represent the number 0. Note: Some receivers interpret the numbers 10, 11, 12, 13, 14, and 15 as hexadecimal characters A, B, C, D, E, and F respectively.

#### **81 - TRANSMISSION FORMAT (TELEPHONE NUMBER 1)**

Enter a value of "0" to "7" to select the communicator transmission format for telephone number 1. Refer to Table 6.

- 0 = Autobaud. Format 1 or 2 automatically selected based upon the handshake tone from the receiver.
- 1 = 1400 Hz. handshake, 1900 Hz. data, 10 baud. (Ademco, Adcor, FBI, Osborne Hoffman, Radionics, Silent Knight, Varitech, and Vertex, slow format).
- 2 = 2300 Hz. handshake, 1800 Hz. data, 20 baud. (DCI, FBI, Franklin, Osborne Hoffman, Sescoa, Varitech, and Vertex, fast format).
- 3 = 1400 Hz. or 2300 Hz. handshake, 1800 Hz. data, 40 baud. (Radionics superfast no parity).
- 4 = 1400 Hz. handshake, 1900 Hz. data, 15 baud. (Silent Knight fast format).
- 5 = Radionics BFSK ® (1400 Hz. or 2300 Hz. handshake). (FBI, Radionics, and Varitech).
- 6 = Sescoa Model 3000, slow format.
- 7 = Sescoa Model 3000, fast format.

**TABLE 6 COMMUNICATOR TRANSMISSION FORMATS**

**82 - SINGLE ROUND REPORTING (TELEPHONE NUMBER 1)**

Some older central station receivers can only receive one report per telephone call. A value of "1" instructs the communicator to hang up after each single report and dial the central station for additional reports. **NOTE: Extended reports cannot be used with single round reporting.**

**83 - 4/2 TRANSMISSION FORMAT (TELEPHONE NUMBER 1)**

A value of "1" enables 4/2 Transmission format. This is a form of extended reporting whereby the account code, consisting of four digits, is transmitted followed by 2 additional digits. The first of these 2 additional digits represents the report code and the second represents the extended code.

**84 - STANDARD 2 LINE EXTENDED REPORTING (TELEPHONE NUMBER 1)**

A value of "1" enables standard 2 line extended transmission format. In this reporting format, the central station will receive its report on two printed lines. The example below details a burglar report from zone 4 of customer account number 268. Zone 4 was programmed to report a code 3 "Burglary".

EXAMPLE:	LINE 1:	268 (ACCOUNT CODE)	3 (REPORT CODE)
	LINE 2:	333 (REPORT CODE 3 TIMES)	4 (EXTENDED CODE, zone #4 in this example)

The central station will identify this as: Account 268, report code 3 (burglary) from zone 4.

**85 - SINGLE LINE EXTENDED (RADIONICS A+) REPORTING (TELEPHONE NUMBER 1)**

This format is similar to standard extended format with the exception that report codes from 1 to 10 are not extended, while all codes from 11 ("B" hex.) thru 15 ("F" hex.) are. When transmitting to a Radionics or compatible receiver, the full report will be received and printed on a single line. In order for alarms, restores, etc. to be transmitted properly with this format, each zone report code must be programmed with the corresponding zone number respectively. When sending to Radionics type receivers, the following values will be printed as: 11 = OPENING, 12 = CLOSING, 13 = CANCEL(ABORT), 14 = RESTORAL, and 15 = TROUBLE.

\* When programming for Radionics Superfast (3) format, EITHER Extended Standard or Single Line Extended (Radionics A+) may be programmed but NEVER BOTH.

\*\* When programming for Radionics BFSK (5) format, one CANNOT select Extended Standard, Single Line Extended (Radionics A+) or Parity Checksum (Radionics). The value of these functions must be programmed as "0".

**86 - PARITY CHECKSUM (RADIONICS) (TELEPHONE NUMBER 1)**

This function commands the communicator to transmit only one line of data containing the account and report code followed by a parity checksum digit for verification rather than sending each line of data twice. The system calculates the parity digit automatically by summing the total of the account and report codes. This feature is most commonly used when transmitting to Radionics receivers and transmission speed is generally faster and telephone connect time is reduced. A value of "1" enables this feature.

**87 TOUCHTONE ® DIALING (TELEPHONE NUMBER 1)**

A value of "1" enables the communicator to dial using touchtone ®. A value of "0" enables rotary (pulse) dialing.

#### **88-103 - ZONES 1 - 16 REPORTING CODES (TELEPHONE NUMBER 1)**

Value programmed in each location represents the code that the corresponding hardwire zone will report to the central station receiver (Function 88 corresponds to zone 1, 89 to zone 2 etc.). Valid range is 0-15. A value of 0 disables reporting of the assigned zone. A reporting code of 0 is possible by entering a value of 10. Some receivers interpret values of 10 thru 15 as hexadecimal codes A thru F.

#### **104 - KEYPAD ACTIVATED AUXILIARY "A" REPORTING CODE (TELEPHONE NUMBER 1)**

Code reported when keypad Auxiliary "A" is activated. Valid range is 0-15. A value of "0" disables reporting.

#### **105 - KEYPAD ACTIVATED AUXILIARY "B" REPORTING CODE (TELEPHONE NUMBER 1)**

Code reported when keypad Auxiliary "B" is activated. Valid range is 0-15. A value of "0" disables reporting.

#### **106 - KEYPAD ACTIVATED AUXILIARY "C" REPORTING CODE (TELEPHONE NUMBER 1)**

Code reported when keypad Auxiliary "C" is activated. Valid range is 0-15. A value of "0" disables reporting.

#### **107 - DURESS REPORTING CODE (TELEPHONE NUMBER 1)**

Code reported when a duress arm/disarm code is entered at the keypad. The extended reporting code which identifies the User is programmed in Functions 294 - 310. Valid range is 0-15. A value of "0" disables reporting.

#### **108 - OPENING REPORT CODE (TELEPHONE NUMBER 1)**

Code reported upon disarming the control. For exception opening see Function 76. The extended reporting code which identifies the User is programmed in Functions 294 - 310. Valid range is 0-15. A value of "0" disables reporting.

#### **109 - CLOSING REPORT CODE WITH RINGBACK (TELEPHONE NUMBER 1)**

Code reported upon arming the control. The extended reporting code which identifies the User is programmed in Functions 294 - 310. If this feature is selected, the control stations will beep six times followed by a two second error tone after a kiss-off tone has been received from the central station receiver. Exit delay will then be restarted and the armed output, J-16 pin 8 will activate. This output may be used to remote an LED. Valid range is 0-15. A value of "0" disables reporting.

**NOTE: When arming or disarming using a keyswitch zone, the system will report the opening or closing code followed by the extended code as programmed in Function 311 to identify that the keyswitch was used.**

#### **110 - SHUNT REPORTING CODE (TELEPHONE NUMBER 1)**

Common code reported whenever the control is armed with a shunted zone, regardless of the zone number. The extended reporting code which identifies the zone is programmed in Functions 344 - 359. Valid range is 0-15. A value of "0" disables reporting.

#### **111 - CANCEL REPORTING CODE (TELEPHONE NUMBER 1)**

Code reported when an alarm transmission is aborted. The extended reporting code which identifies the user is programmed in Functions 294 - 310. Valid range is 0-15. A value of "0" disables reporting.

#### **112 - ZONE RESTORE REPORTING CODE (TELEPHONE NUMBER 1)**

Code reported when a zone which caused the alarm is restored to operation. The extended reporting code which identifies the zone is programmed in Functions 328 - 343. Valid range is 0-15. A value of "0" disables reporting.

#### **113 - SUPERVISORY REPORTING CODE (TELEPHONE NUMBER 1)**

Code reported when a zone programmed for supervisory is activated. The extended reporting code which identifies the zone is programmed in Functions 360 - 375. Valid range is 0-15. A value of "0" disables reporting.

#### **114 - LOW BATTERY/FUSE BLOWN REPORTING CODE (TELEPHONE NUMBER 1)**

Code reported when a low battery or blown fuse is detected. The extended reporting code is programmed in Function 377. Valid range is 0-15. A value of "0" disables reporting. **NOTE: U.L. requires low battery reporting for Grade A Local Burglar, Grade A Police Station Connected and Grade B and C Central Station Burglar Installations.**

#### **115 - BATTERY/FUSE RESTORE REPORTING CODE (TELEPHONE NUMBER 1)**

Code reported after the restoral of a low battery condition or blown fuse. A battery test must occur before the code will transmit. The extended reporting code is programmed through Function 377. Valid range is 0-15. A value of "0" disables reporting.

#### **116 - AC FAILURE REPORTING CODE (TELEPHONE NUMBER 1)**

Code reported when AC power is interrupted for more than approximately 5 minutes. The extended reporting code is programmed through Function 376. Valid range is 0-15. A value of "0" disables reporting.

#### **117 - AC RESTORE REPORTING CODE (TELEPHONE NUMBER 1)**

Code reported when AC power is restored. The extended code is programmed in Function 376. Valid range is 0-15. A value of "0" disables reporting.

#### **118 - EEPROM MEMORY ERROR REPORTING CODE (TELEPHONE NUMBER 1)**

Code reported when an EEPROM memory error is detected. The extended reporting code is programmed in Function 378. Valid range is 0-15. A value of "0" disables reporting.

#### **119 - COMMUNICATOR TEST REPORTING CODE (TELEPHONE NUMBER 1)**

Code reported when communicator performs a test. Time between tests is set in Function 32. The extended reporting code is programmed in Function 379. Valid range is 0-15. A value of "0" disables reporting.

#### **120-145 - TELEPHONE NUMBER 1**

Enter the number to be dialed for telephone number 1 in functions 120 through 145. Valid range is 0-15. A value of 0 or 10 represents dialing digit 0. A value of 11 represents a " \* " and 12 represents a " # ", when using Touchtone ® dialing. A value of 13 instructs the communicator to pause for three seconds before dialing the next digit and a value of 14 instructs the communicator to wait 10 seconds for a second dial tone. A value of 15 must be programmed in the location following the last dialing digit d to signify end of dialing.

#### **146 - AUDIO LISTEN-IN CAPABILITY (TELEPHONE NUMBER 1)**

The monitoring central station can receive One (1) minute of audio listen-in immediately following a transmission from the Digital Communicator and the subsequent receiver "kiss-off" by connecting an amplified/filtered microphone (Bluegrass AS-6000-SL/AS-75 or equivalent) to the listen-in post (see Figure 18) on the control board and then programming a value of "1" into this Function. **Note: Listen-in will only occur when telephone #1 calls the central station unless Function 219 ( audio listen-in telephone #2) is also programmed with a "1". This can be a useful feature to "SPLIT" the operation of listen-in to a separate receiver.**

#### **147 - FOR FUTURE USE (EXITS TO PROGRAMMING ENTRY MODE)**

Entry into this location will command the system to return to the point where programming is first entered with all LEDs flashing for verification just as it did when program mode was initially entered. This Function is a stopping block to prevent unintentional entry of the location that follows.

#### **148 - COPY TELEPHONE NUMBER 1 ACCOUNT, FORMATS, AND REPORT CODES TO TELEPHONE NUMBER 2**

Entry into this location will command the system to copy all of the values in Functions 77 - 86 and 88 - 119 and duplicate them into Functions 150 - 192. **NOTE: No values may be programmed into this location.**

#### **149 - COPY TELEPHONE NUMBER 1 TO TELEPHONE NUMBER 2**

Entry into this location will command the system to copy all of the values in Functions 120 - 145 and enter them into Functions 193 - 218. **NOTE: No values may be programmed into this location.**

#### **150-153 - ACCOUNT NUMBER (TELEPHONE NUMBER 2)**

Functions 150 to 153 store the 3 or 4 digit account code. Valid range is 0-15. Please refer to Functions 77-80 for additional important information.

#### **154 - TRANSMISSION FORMAT (TELEPHONE NUMBER 2)**

Program the value in the same manner as location 81.

#### **155 - SINGLE ROUND REPORTING (TELEPHONE NUMBER 2)**

Program the value in the same manner as location 82.

#### **156 - 4/2 TRANSMISSION FORMAT (TELEPHONE NUMBER 2)**

Program the value in the same manner as location 83.

#### **157 - STANDARD 2 LINE EXTENDED REPORTING (TELEPHONE NUMBER 2)**

Program the value in the same manner as location 84.

#### **158 - SINGLE LINE EXTENDED (RADIONICS A+) REPORTING (TELEPHONE NUMBER 2)**

Program the value in the same manner as location 85.

#### **159 - PARITY CHECKSUM (RADIONICS) (TELEPHONE NUMBER 2)**

Program the value in the same manner as location 86.

#### **160 - TOUCHTONE ® DIALING (TELEPHONE NUMBER 2)**

A value of "1" enables the communicator to dial using touchtone ®. A value of "0" enables rotary (pulse) dialing.

**161-176 - ZONES 1-16 REPORTING CODES (TELEPHONE NUMBER 2)**

Value programmed in each location represents the codes that the corresponding hardwire zone will report to the central station receiver (Function 161 corresponds to zone 1, 162 to zone 2 etc.). Determine program values in the same manner as locations 88 -103. Valid range is 0-15. A value of "0" for any selected location disables its reporting.

**177 - KEYPAD ACTIVATED AUXILIARY "A" (FIRE ff) REPORTING CODE (TELEPHONE NUMBER 2)**

Code reported when keypad Auxiliary "A" is activated. Valid range is 0-15. A value of "0" disables reporting.

**178 - KEYPAD ACTIVATED AUXILIARY "B" (POLICE) REPORTING CODE (TELEPHONE NUMBER 2)**

Code reported when keypad Auxiliary "B" is activated. Valid range is 0-15. A value of "0" disables reporting.

**179 - KEYPAD ACTIVATED AUXILIARY "C" (EMERGENCY) REPORTING CODE (TELEPHONE NUMBER 2)**

Code reported when keypad Auxiliary "C" is activated. Valid range is 0-15. A value of "0" disables reporting.

**180 - DURESS REPORTING CODE (TELEPHONE NUMBER 2)**

Code reported when a duress arm/disarm code is entered at the keypad. The extended reporting code which identifies the User is programmed in Functions 294 - 310. Valid range is 0-15. A value of "0" disables reporting.

**181 - OPENING REPORT CODE (TELEPHONE NUMBER 2)**

Code reported upon disarming the control. For exception opening see Function 76. The extended reporting code which identifies the User is programmed in Functions 294 - 310. Valid range is 0-15. A value of "0" disables reporting.

**182 - CLOSING REPORT CODE WITH RINGBACK (TELEPHONE NUMBER 2)**

Code reported upon arming the control. The extended reporting code which identifies the User is programmed in Functions 294 - 310. See Function 109 for further details. Valid range is 0-15. A value of "0" disables reporting.

**183 - SHUNT REPORTING CODE (TELEPHONE NUMBER 2)**

Code reported when the control is armed with a zone shunted. The same code will be reported for any shunted zone. The extended reporting code which identifies the zone is programmed in Functions 344 - 359. Valid range is 0-15. A value of "0" disables reporting.

**184 - CANCEL REPORTING CODE (TELEPHONE NUMBER 2)**

Code reported when an alarm transmission is aborted. The extended reporting code which identifies the User is programmed in Functions 294 - 310. Valid range is 0-15. A value of "0" disables reporting.

**185 - RESTORE REPORTING CODE (TELEPHONE NUMBER 2)**

Code reported when a zone which caused an alarm is restored to operation. The extended reporting code which identifies the zone is programmed in Functions 328 - 343. Valid range is 0-15. A value of "0" disables reporting.

**186 - SUPERVISORY REPORTING CODE (TELEPHONE NUMBER 2)**

Code reported when a zone programmed for supervisory is activated. The extended reporting code which identifies the zone is programmed in Functions 360 - 375. Valid range is 0-15. A value of "0" disables reporting.

**187 - LOW BATTERY/FUSE BLOWN REPORTING CODE (TELEPHONE NUMBER 2)**

Code reported when a low battery voltage or blown fuse is detected. The extended reporting code is programmed in Function 377. Valid range is 0-15. A value of "0" disables reporting. **NOTE: U.L. requires low battery reporting for Grade A Local Burglar, Grade A Police Station Connected and Grade B and C Central Station Burglar Installations.**

**188 - BATTERY/FUSE RESTORE REPORTING CODE (TELEPHONE NUMBER 2)**

Code reported after the restoral of a low battery condition or blown fuse. The extended reporting code is programmed in Function 377. Valid range is 0-15. A value of "0" disables reporting. A battery test must occur before this code will transmit.

**189 - AC FAILURE REPORTING CODE (TELEPHONE NUMBER 2)**

Code reported when AC power is interrupted for more than approximately 5 minutes. The extended reporting code is programmed in Function 376. Valid range is 0-15. A value of "0" disables reporting.

**190 - AC RESTORE REPORTING CODE (TELEPHONE NUMBER 2)**

Code reported when AC power is restored to the control. The extended reporting code is programmed in Function 376. Valid range is 0-15. A value of "0" disables reporting.

**191 - EEPROM MEMORY ERROR REPORTING CODE (TELEPHONE NUMBER 2)**

Code reported when an EEPROM memory error is detected. The extended reporting code is programmed in Function 378. Valid range is 0-15. A value of "0" disables reporting.

#### **192 - COMMUNICATOR TEST REPORTING CODE (TELEPHONE NUMBER 2)**

Code reported when communicator performs a test. Time between tests is set in function 32. The extended reporting code is programmed in Function 379. Valid range is 0-15. A value of "0" disables reporting.

#### **193-218 - TELEPHONE NUMBER 2**

Program the number to be dialed for telephone number 2 in the same manner as programmed in functions 120 thru 145.

#### **219 - AUDIO LISTEN-IN CAPABILITY (TELEPHONE NUMBER 2)**

A value of "1" will enable audio listen-in devices to activate for One (1) minute after receiving the receiver "kiss-off" when the central station is called using telephone #2. (See Function 146)

#### **220 - NUMBER OF RINGS UNTIL AUTO ANSWER**

The control may be programmed to automatically pick-up and answer the telephone line after 1 to 15 rings. This Function must be programmed in order for the "auto answer callback method" of remote programming to operate. (See SPECIAL FEATURES, REMOTE PROGRAMMING) Valid range is 0-15. A value of "0" will disable the auto answer callback method.

#### **221-246 - CALLBACK TELEPHONE NUMBER (REMOTE PROGRAMMING)**

Enter the callback telephone number of the remote programming computer that the control is to dial when remote programming is enabled. Program the number to be dialed in the same manner as programmed in functions 120 thru 145. Valid range is 0-15. A value of "15" for Function 221 will disable the callback telephone number.

#### **247 - SX-3104 EIGHT ZONE EXPANDER ENABLED**

A value of "1" is automatically programmed into this location when the SX-3104 module is plugged in. Program a value "0" to disable.

#### **248 - TWO DIGIT ARMING**

A value of "1" in this location will command the system to arm whenever "command 1" plus the first digit of a user authorization code is entered from a control station. The full code will still be required to disarm. **Note: If this feature is selected, and the first digit of any user authorization code is the same as the first digit of the programming authorization code, use of the programming code will be disabled.**

#### **249 - ENABLE FORCE ARMING**

A value of "1" in this location enables force arming. Force arming allows the control to arm even while a zone is faulted. When a user attempts to arm the system with a faulted zone, the control station will emit a 2 second error tone indicating that the control refused to arm. If the code is re-entered within 8 seconds after the tone quits, the control will "force arm" and the faulted zone(s) will be either temporarily or permanently bypassed, depending on the selection of Function 250. If the code is not re-entered within 8 seconds another error tone sounds to indicate that the allowed time to re-enter the code has expired.

#### **250 - TEMPORARY OR PERMANENT FORCE ARMING**

A value of "0" in this function selects "temporary" force arming which allows a zone that has been force armed to automatically be placed back into service when and if restored. A value of "1" selects "permanent" force arming whereby the zone will remain bypassed until the system is disarmed.

#### **251 - DELAY BURGLAR ZONE RESTORE CODE TRANSMISSION UNTIL ALARM CUT-OFF TIME EXPIRES**

In normal operation, a restoral report, if programmed, is transmitted as soon as the zone restores. Entering a value of "1" in this location prevents the communicator from transmitting a restored zone report until after the alarm cut-off time has expired and the zone has restored. If restoral reports are not programmed, this function can still be used to limit transmissions in the event of a continuously triggering detection device. When this function is programmed, the violated zone cannot report another alarm condition until the alarm cut-off time has expired and the zone has restored.

#### **252 - BURGLAR ALARM REPORTS UNTIL LOCKOUT**

This Function may be programmed to limit the maximum number of successful communicator burglar alarms (from 1 to 15) that may be reported during an armed cycle or timed period. When this value is reached, the communicator will not report another burglar alarm until the system is disarmed and reset or until the automatic test timer expires. This prevents a "runaway" condition which can be caused by a faulty zone or detector. **NOTE: This function effects ONLY burglar defined zone alarms and only locks out after the number of SUCCESSFUL reports. It has no effect on Functions 68 & 69. This Function will not work if function 263 is also selected.**

#### **253 - PULSING BURGLAR ALARM OUTPUT**

A value of "1" instructs burglar alarm output (J-16 pin 12) to repeatedly pulse, one second on and one second off whenever activated. A value of "0" programs the output to be steady.

#### **254 - PULSING AUXILIARY "A" (FIRE ff) ALARM OUTPUT**

A value of "1" instructs Auxiliary "A" alarm output (J-16 pin 11) to repeatedly pulse, one second on and one second off whenever activated. A value of "0" programs the output to be steady.



**255 - BURGLAR LOOP AUDIBLE LOCKOUT**

A value of "1" instructs burglar alarm output (J-16 pin 12) to function only once per arm/disarm cycle. The communicator, if enabled will continue to send reports as each zone is violated.

**256 - MECHANICAL KEYSWITCH MODE CHANGE**

A value of "1" in this location allows key switch change of Interior and Delay modes from a key defined zone. See SPECIAL FEATURES.

**257 - DAY ALERT LATCH**

A value of "1" commands the supervisory/trouble condition to latch on until manually cleared by pressing the " \* " key .

**258 - AUTOMATIC INTERIOR OFF**

A value of "1" in this location commands the system to automatically switch the interior defined zones OFF at the expiration of the exit delay if no delay zones are violated during the exit time. This eliminates the user from having to manually turn interior off if staying in the building.

**259 - AUTOMATIC DELAY OFF**

A value of "1" in this location commands the system to automatically switch the entry delay to OFF at the expiration of the exit delay if no delay zones are violated during the exit time. This eliminates the user from having to manually turn delay off if staying in the building.

**260 - DISABLE INTERIOR FOLLOWER**

The control automatically ignores all interior defined zones upon entry through a delay defined zone. This allows the motion detectors to be placed between the entry delay door and the control station. A value of "1" in this location disables the interior follower feature allowing all interior defined zones to remain instant during the entrance delay period.

**261 - SIREN /BELL TEST UPON ARMING**

A value of "1" in this location enables a one second burglar alarm output (J-16 pin 12) whenever the control is armed. The communicator will not report this alarm. **NOTE: U.L. requires a burglar alarm bell test for Grade A Local Installations.**

**262 - SLAVE MODE OPERATION**

A value of "1" in this location converts the control panel to "slave" mode operation. The control can then only be armed/disarmed from a "master" defined control panel. See SPECIAL FEATURES for details.

**263 - RESET TEST TIMER AFTER SUCCESSFUL REPORT**

A value of "1" in this location causes the automatic test timer to reset after receiving a valid kiss-off signal from the central station receiver. The automatic test will occur 24 hrs after the last successful transmission or as set in Function 32.

**264 - INTERIOR/DELAY DEFAULT ON DISARM**

The interior and delay modes automatically return to the preset (default) on or off status whenever the system is disarmed. The default on disarm may be selected by entering a value of 0 - 3 from the table below.

VALUE	INTERIOR	DELAY
0	ON	ON
1	OFF	ON
2	ON	OFF
3	OFF	OFF

**TABLE 7 DEFAULT ON DISARM**

**265 - COMMAND 4 (INTERIOR ON/OFF) AND 5 (DELAY ON/OFF) AVAILABLE WHEN CONTROL IS ARMED**

A value of "1" in this location will allow the interior and delay command to be operated even if the system is armed. A value of "0" will allow changes to interior and delay only when the system is disarmed.

**266 - DISABLE KEYPAD AUXILIARY "A" (FIRE ff)**

A value of "1" in this location disables the ability to activate Auxiliary "A" (fire ff) from the control stations or the SX-3103 module.

**267 - DISABLE KEYPAD AUXILIARY "B" (POLICE)**

A value of "1" in this location disables the ability to activate "Auxiliary "B" (police) from the control stations or the SX-3103 module.

**268 - DISABLE KEYPAD AUXILIARY "C" (EMERGENCY)**

A value of "1" in this location disables the ability to activate "Auxiliary "C" (emergency) from the control stations or the SX-3103 module.

**69 - DISABLE KEYPAD SHUNTING**

A value of "1" in this location disables the ability to manually shunt zones from the control stations.

**270 - DISABLE KEYPAD CHANGE OF INTERIOR ON/OFF**

A value of "1" in this location disables the ability to turn the interior on or off from the control stations.

**271 - DISABLE KEYPAD CHANGE OF DELAY ON/OFF**

A value of "1" in this location disables the ability to turn the delay on or off from the control stations.

**272 - DISABLE KEYPAD CHANGE OF ZONE MONITOR ON/OFF**

A value of "1" in this location disables the ability to turn the zone monitor on or off from the control stations.

**273 - DISABLE KEYPAD PERFORMED BATTERY TEST/SMOKE (ff) RESET**

A value of "1" in this location disables the ability to perform battery tests and reset smoke detectors (ff) from the control stations.

**274 - DISABLE KEYPAD PERFORMED ZONE WALK TEST**

A value of "1" in this location disables the ability to perform a zone walk test from the control stations.

**275 - SILENT KEYPAD ON BURGLAR ACTIVATION**

A value of "1" in this location instructs all control stations to be silent during a burglar alarm activation.

**276 - DISABLE CONTROL AUDIBLE OR VISUAL INDICATION ON AUXILIARY "B" (POLICE) ACTIVATION**

A value of "1" in this location instructs the control stations not to display visual or audible notification of a Auxiliary "B" (police) activation whether activated from the control station zone or a hardwired Auxiliary "B" zone.

**277 - START ENTRANCE DELAY 1 UPON KEYPAD ENTRIES**

A value of "1" in this location instructs the control stations to begin entrance delay 1 when a keypad key is pressed while armed. This feature provides additional protection against control station tampering for higher levels of security.

**278 - 293 SUPERVISORY/TROUBLE DETECTION ON OPEN OR SHORT? (ZONES 1 - 16)**

Any of the 16 hardwire zones may be defined for supervisory/trouble detection by programming of the zone definitions (functions 51 - 66). Functions 278 thru 293 define whether a trouble condition will be detected due to a short or open in the corresponding zone. A value of "0" instructs the control to detect trouble from a loop open and a value of "1" from a loop short. Functions 278 thru 293 correspond directly to zones 1 thru 16 respectively (function 278 = zone 1, 279 = zone 2, etc.).

**FUNCTIONS 294 TO 383 ARE USED TO SELECT THE EXTENDED REPORTING DIGITS.  
IF EXTENDED REPORTING IS NOT UTILIZED SKIP TO FUNCTION 402.**

The following functions are for programming extended reporting codes when an extended reporting format has been selected. If extended reporting is not selected, functions 294 thru 383 may be skipped. If extended reporting is used, code values possible are 1 thru 15. An extended code of 0 is possible by entering a value of 10 (0 represents the tenth digit). Some receivers receive values of 10 thru 15 as hexadecimal codes A, B, C, D, E, & F.

**294-310 - USER AUTHORIZATION CODE 1-17 EXTENDED REPORTING CODES**

The value in each location represents the extended code which will identify the corresponding user authorization code used to either arm/disarm, shunt, or cancel an alarm when any of those conditions are programmed to report to the central station receiver.

**311 - KEYSWITCH ZONE EXTENDED CODE**

The value in this location represents the extended code transmitted whenever the control is armed/disarmed using a key switch zone.

**312-327 - ZONE 1-16 EXTENDED ALARM REPORTING CODES**

The value in each location represents the extended code which will identify the corresponding hardwire zone when an alarm report is transmitted to the central station receiver.

**328-343 - ZONE 1-16 EXTENDED RESTORE REPORTING CODES**

The value in each location represents the extended code which will identify the corresponding hardwire zone when a zone restore report is transmitted to the central station receiver.

**344-359 - ZONE 1-16 EXTENDED SHUNT REPORTING CODES**

The value in each location represents the extended code which will identify the corresponding hardwire zone when a shunted zone report is transmitted to the central station receiver.

### **360-375 - ZONE 1-16 EXTENDED SUPERVISORY/TROUBLE REPORTING CODES**

The value in each location represents the extended code which will identify the corresponding hardwire zone when a supervisory/trouble condition is detected and transmitted to the central station receiver.

### **376 - EXTENDED AC POWER REPORTING CODE**

The value in this location represents the extended code reported when an AC power failure or AC power restoral code is transmitted to the central station receiver.

### **377 - EXTENDED LOW BATTERY/FUSE BLOWN REPORTING CODE**

The value in this location represents the extended code reported when a low battery/blown fuse or battery/fuse restoral code is transmitted to the central station receiver.

### **378 - EXTENDED MEMORY ERROR REPORTING CODE**

Value programmed in this location represents the extended digit reported when an EEPROM memory error condition is transmitted.

### **379 - EXTENDED TEST REPORTING CODE**

Value programmed in this location represents the extended code reported when a communicator/battery test is conducted or upon initial power-up (see Function 75).

### **380 - EXTENDED KEYPAD AUXILIARY "A" (FIRE ff)REPORTING CODE**

Value programmed in this location represents the extended code reported when keypad Auxiliary "A" (fire ff) is transmitted.

### **381 - EXTENDED KEYPAD AUXILIARY "B" (POLICE)REPORTING CODE**

Value programmed in this location represents the extended code reported when keypad Auxiliary "B" (police) is transmitted.

### **382 - EXTENDED KEYPAD AUXILIARY "C" (EMERGENCY)REPORTING CODE**

Value programmed in this location represents the extended code reported when keypad Auxiliary "C" (emergency) is transmitted.

### **383 - EXTENDED MISSING KEYPAD REPORT**

Value programmed in this location represents the extended code reported when a missing keypad is detected. This code is used as an identification digit only and will not report unless supervisory/trouble conditions are being reported to the central station receiver. A missing keypad activates the control station supervisory/trouble LED. See POWER-UP AND CONTROL STATION OPERATION.

### **384-401 - RESERVED FOR FUTURE USE (EXITS TO PROGRAMMING ENTRY MODE (SEE FUNCTION 147)**

### **402 - "FAST" LOOP RESPONSE TIME 1**

Time in milliseconds that a loop violation must be maintained before an alarm will be recognized on any hardwired zone defined as "FAST RESPONSE". The value programmed is automatically multiplied x 40 milliseconds by the control and the resulting value is the loop response time. A value of "2" will equal 80 milliseconds loop response, value of "10" = 400 milliseconds, etc. **NOTE: 80 milliseconds should be the minimum time programmed and U.L. requires that loop response not exceed one second (a value of 25).**

### **403 - "SLOW" LOOP RESPONSE TIME 2**

Time in milliseconds that a loop violation must be maintained before an alarm will be recognized on any hardwired zone defined as "SLOW RESPONSE". See Function 402.

### **404 - RESERVED FOR FUTURE USE (EXITS TO PROGRAMMING ENTRY MODE (SEE FUNCTION 147)**

### **405 - RESTORE FACTORY DEFAULTS (NEW EEPROM VALUES)**

Factory default EEPROM values may be restored by first entering a "1" in this location, and then exiting the program mode. After exiting, the control will restore all factory defaults after approximately 5 seconds. **NOTE: This function replaces all installer and user level programming values returning the control to factory default values as shipped and disables all central station communication.**

### **406 - LOCKOUT USER FUNCTIONS 1-8**

This Function provides a means of locking out the user level programming of Functions 1 through 8. Using Table 8, select each Function number to be locked out and place the corresponding value from the value column into the space provided in the selection column. Add the values in the selection column and place the result into the bottom block marked TOTAL VALUE. The total value should be programmed into the location indicated in order to lockout User Level programming of the selected Functions.

### **407 - LOCKOUT USER FUNCTIONS 9-16**

Make selections and determine values in the same manner as location 406.

**408 - LOCKOUT USER FUNCTIONS 17-24**

Make selections and determine values in the same manner as location 406. Default value is 192 which locks out functions 23-24.

**409 - LOCKOUT USER FUNCTIONS 25 - 32**

Make selections and determine values in the same manner as location 406. Default value is 255 which locks out functions 25-32.

FUNCTION	VALUE	SELECTION
001 USER CODE 1	1	
002 USER CODE 2	2	
003 USER CODE 3	4	
004 USER CODE 4	8	
005 USER CODE 5	16	
006 USER CODE 6	32	
007 USER CODE 7	64	
008 USER CODE 8	128	
FUNCTION 406 TOTAL VALUE = [0]		
LOCKOUT USER FUNCTIONS 001 - 008		

FUNCTION	VALUE	SELECTION
017 USER CODE 17	1	
018 USER PROGRAM CODE	2	
019 USAGE COUNT CODE 17	4	
020 TIME TILL NEXT TEST	8	
021 CLEAR ALARM MEMORY	16	
022 DELETE CODES	32	
023 ENTRANCE DELAY 1	64	[64]
024 ENTRANCE DELAY 2	128	[128]
FUNCTION 408 TOTAL VALUE = [192]		
LOCKOUT USER FUNCTIONS 017 - 024		

FUNCTION	VALUE	SELECTION
009 USER CODE 9	1	
010 USER CODE 10	2	
011 USER CODE 11	4	
012 USER CODE 12	8	
013 USER CODE 13	16	
014 USER CODE 14	32	
015 USER CODE 15	64	
016 USER CODE 16	128	
FUNCTION 407 TOTAL VALUE = [0]		
LOCKOUT USER FUNCTIONS 009 - 016		

FUNCTION	VALUE	SELECTION
025 EXIT DELAY TIME	1	[1]
026 ACCESS ON TIME	2	[2]
027 DELAY BURGLAR OUTPUT	4	[4]
028 BURGLAR CUTOFF TIME	8	[8]
029 AUX. "A" (FIRE ff) CUTOFF	16	[16]
030 AUX. "B" (POLICE) CUTOFF	32	[32]
031 AUX. "C" (EMER) CUTOFF	64	[64]
032 TIME BETWEEN TEST	128	[128]
FUNCTION 409 TOTAL VALUE = [255]		
LOCKOUT USER FUNCTIONS 025 - 032		

**TABLE 8 LOCKOUT USER FUNCTIONS**

**410 - INSTALLER PROGRAM CODE**

The Installer Program code is programmed in the same manner and functions identically to the standard program authorization code (Function 18) with one exception. Whenever this code is entered the control responds as if the program switch SW1 (See Figure 18) on the control board had been pressed. This allows re-entry into Installer Level programming without having to return to the control panel to press the program switch. This code can be programmed during initial installation or servicing and is automatically deleted whenever the control performs the automatic 24 hour battery test. It also may be manually deleted by entering a "00" into Function 22.

**411 - INTERNAL CLOCK ADJUST (CONSULT FACTORY BEFORE PROGRAMMING THIS FUNCTION)**

**412 - FACTORY USE ONLY (IF THIS FUNCTION IS ACCIDENTALLY ENTERED PRESS "7" TO EXIT)**

**413 - TONE TEST GENERATION (FACTORY USE ONLY. NO VALUES MAY BE PROGRAMMED INTO THIS LOCATION)**

**414 - FACTORY ID (FACTORY USE ONLY. NO VALUES MAY BE PROGRAMMED INTO THIS LOCATION)**

**THIS PAGE INTENTIONALLY LEFT BLANK**

## 8. SPECIAL FEATURES

### 1) REMOTE PROGRAMMING (UPLOADING AND DOWNLOADING)

A powerful feature of the control is the ability to be re-programmed and/or controlled remotely over a standard telephone line using an IBM PC® or compatible computer, a Hayes® modem or compatible and the software package "TRANSPORT PC"®. Each function of the control may be individually programmed while on line or the entire memory contents may be uploaded/downloaded with only a few keystrokes. An upload or download usually requires approximately 1 to 2 minutes. The software is available direct from the factory and requires a licensing agreement contract. Contact the factory sales department for information. There are two methods of remote programming. The following is a description of each method along with the basic operation.

- **ON-SITE "MANUALLY" ASSISTED METHOD**

Establish a telephone connection between the computer site and the telephone that is connected to the control. Select the "Answer" mode on the computer. Instruct the individual at the control to press command "9" and enter their program authorization code. After this is done, they should then select Function 33 and press the "\*" (FIND) key. The control will seize the phone line and begin a complete upload to the computer. When this is complete the control will await any re-programming commands. This method is the most secure method of remote programming since it requires assistance at the control panel site.

- **AUTO ANSWER AND CALLBACK METHOD**

This method requires two programming Functions to be set in order to operate properly. (1) Program Function 220 (Rings until auto answer) must have a value of 1 - 15. A value of "0" will disable auto answer. (2) Functions 221 through 246 must be programmed with the callback telephone number of the computer. The Function following the last telephone digit must be a value of "15".

In operation, the computer dials the telephone number of the control. Upon detecting the programmed number of rings, the control will answer the call and produce a handshake signal. If the proper computer response is received, the control will hang-up and dial the callback telephone number. When the computer answers the callback, various security procedures take place before any programming information can be exchanged. These include: A security access code, computer operator security code, computer operator levels of access, as well as logging of all computer transactions. If the control does not receive the proper computer response or if the callback is not answered within a preset time limit, the control will reset to regular operation. The control will make a second attempt if the first attempt fails. This method virtually eliminates computer hackers from gaining access to the control.

**NOTE: Both methods of remote programming have extensive built-in security features, however none are as important as proper operator screening and training to reduce the liabilities involved with this feature.**

### 2) ZONE EXPANSION - USE OF SX-3104 EIGHT ZONE EXPANSION BOARD

The eight(8) hardwire zones may be expanded to sixteen(16) by using the optional SX-3104 zone expander. Each of the eight additional zones may be defined with any of the options available to the original eight. Installation of the SX-3104 is quick and easy. In fact, when the SX-3104 connector is plugged into the control board, the eight additional zones will automatically be enabled. Then, if the SX-3104 is ever unplugged, zones 09-16 will be violated and the control status light will be OFF. Program function 247 may be programmed with a value of "0" to disable the SX-3104 if it is ever permanently removed from the control. Refer to the SX-3104 Instructions.

### 3) PROCESSING OF ALARMS FOLLOWING TOTAL POWER LOSS

If a total power loss occurs (both AC and Battery) while the control is armed, the control will ignore all burglar defined zones for fifteen (15) seconds once the power is restored. The delay is to allow time for devices such as motion detectors, glass break sensors, etc., to power-up and stabilize. This time is also started whenever the microprocessor is reset by the watchdog circuit. If a total power loss occurs while the digital communicator is transmitting, any hardwire activated zone alarms which have been stored in the EEPROM will be reported upon power restoral. **NOTE: Keypad activated alarms as well as supervisory/trouble, opening/closings, restorals, cancels, and test reports are not stored in EEPROM and therefore, will be lost in the event of total power loss.**

### 4) SILENT EXIT DELAY BEEP

The exit beep is silenced automatically when the system is armed with the interior off. This exit beep may be totally disabled by programming in an odd value when programming exit time.(Program function 25).

## 5) SILENT ENTRANCE DELAY BEEP

This entrance delay warning beep may be silenced by selecting an odd value when programming the entrance delay times. Function 23 selects the time for entry delay "1" defined zones, and Function 24 selects the time for entry delay "2" defined zones.

## 6) SUPERVISORY/TROUBLE ZONE SUB-OPTION

Supervisory/Trouble is a programmable zone-sub option which allows Burglar, Auxiliary "B", Auxiliary "C", Communicator report only, and Keyswitch defined zones to react to either an open loop or shorted loop as a trouble instead of an alarm. A choice must be made as to troubles on opens or troubles on shorts. Troubles on loop opens is the factory default if a zone is defined as supervisory/trouble. Upon detection of a supervisory condition the control station will beep and display visual information and report the condition to the central station receiver if so programmed. The control station will continue to display a supervisory condition as long as the condition exists. When the supervisory condition is cleared, the control station will automatically reset unless the control has been programmed for latching supervisory in which case it will be necessary to press the " " key to silence and reset the control station. See Function 257. These loops must be configured as end-of-line resistor supervised loops (see figure 6) if this option is selected.

## 7) KEY DEFINED ZONE

Any one of the hardwire zones may be defined for system momentary or maintained (shunt type) key switch usage. When the momentary key switch is closed and held closed for one second, the pre-alarm will beep to indicate that the key change was acknowledged. When the key switch closure is released, the control will arm/disarm. If programming function 256 is enabled, holding the key switch closed will change the interior on/off and delay/instant modes once each second, then after the interior and delay status is displayed, release the key switch to arm the system. If a zone is programmed for maintained keyswitch usage, the control stations will be disabled from either arming or disarming the control. Only that keyswitch defined zone may be used to arm or disarm. If a momentary key defined zone is further defined as a supervisory zone, a supervisory/trouble condition on that zone will disable the keyswitch from disarming the control. NOTE: Do not define a maintained keyswitch zone for supervisory/trouble conditioning.

## 8) SHUNTABLE 24 HOUR AUXILIARY "A", "B", "C", COMMUNICATOR, AND KEYSWITCH ZONES

The Auxiliary "A", "B", "C", zones, Communicator Report Only, and Keyswitch defined zones may be programmed as shuntable by adding a value of "32" to their base zone definition. Shunting may be performed manually or through the use of a subzone code. Shunting of these zones may be valuable for servicing or in the event of a false alarming detection device. **NOTE: When an Auxiliary "A" (fire ff) zone is shunted, the control station will beep and display a supervisory/trouble condition. If the communicator is enabled and a code is programmed for supervisory/trouble reporting, a report will be transmitted. The control station can be silenced but the trouble condition will continue to be displayed until the shunt is removed and the zone secured.**

## 9) PRIORITY (NON-SHUNTABLE) BURGLAR ZONES

For a higher level of security, all burglar zones can be individually programmed as non-shuntable. This is accomplished by adding "32" to the zone definition value when defining the zone.

## 10) HIGH SECURITY MASTER ARM/DISARM CODE

One or more of the user authorization codes may be programmed as a "master" code by assigning a configuration digit of "4". Whenever the control is armed by a "master" code, it can only be disarmed by that code or another "master" designated code. All other non-master user codes are inoperable when the control is armed by a master code.

## 11) GROUP SHUNTING

One or more zones may be shunted simultaneously with a feature called "Group Shunting". After displaying the faulted zones using the STATUS command, press the shunt key (" # ") followed by an entry of "0 + 0". The faulted zones will automatically be shunted and the control station will automatically display which zones were shunted by blinking the corresponding LEDs.

## 12) SYSTEM EXPANSION - SLAVE/MASTER SYSTEM CONFIGURATION ††

For zone expansion in large installations, one or more controls may be configured as "slaves" connected to a "master" control using a four wire parallel connection. The slave controls will be armed and disarmed by the master. Each control can report alarms to the central station receiver individually. The slave control(s) must have a ready status before arming unless the forced arming feature is enabled. **WARNING:** If forced arming is used, all controls must be programmed for this feature. Each slave control should have a control station connected in order to allow zone shunting, zone status display, alarm memory display, and for silencing emergency alarms. Manual zone shunting can only be performed at the control station directly connected to each slave control. The directly connected control stations may be further used to subzone (disarm) 1 to 7 zones of each slave control, however **ONLY** the keypad of the master control can arm and disarm the entire network.

### SLAVE/MASTER WIRING PROCEDURE

1. Connect a wire from terminal 28(-) on the designated "master" control to terminal 28(-) on each designated "slave" control.
2. Connect a second wire from the small pin marked SLA on the right side of the "master" control board (See Figure 18) to the pin marked SLB on each "slave" control. Connection to pins SLA and SLB should be made with a small soldered on female connector (not supplied). These may also be available at a local electronics supply house.
3. Connect a third wire from the small pin marked SLB on the right side of the "master" control board to the pin marked SLA on each "slave" control.
4. If you want the master control to be the common audible for the slave(s) and itself, connect a fourth wire from the N/O terminal of relay K1 or K2 on the slave(s) to the (+) positive trigger terminal of the siren driver inside the master. Then connect a jumper from terminal 29 (+) 12 Volts to the common terminal of relay K1 or K2. Connect the appropriate (+) alarm outputs from J-16 of the slave control to the (+) trigger of relay K1 or K2. Then whenever the slave control goes into alarm, the appropriate alarm output will activate the common audible inside the master. Another method is to connect the fourth wire to a zone input inside the master rather than to the siren driver. This method will cause the master zone to violate and the alarm memory to latch for this zone.
5. Program a value of "1" into Function 262 of each designated "slave" control. Function 262 on the "master" must be a value of "0"
6. Constant zone status of each slave control may be displayed by adding an optional SX-3101 Output Expansion Module and a SX-3102 8 LED Annunciator Plate for each control.

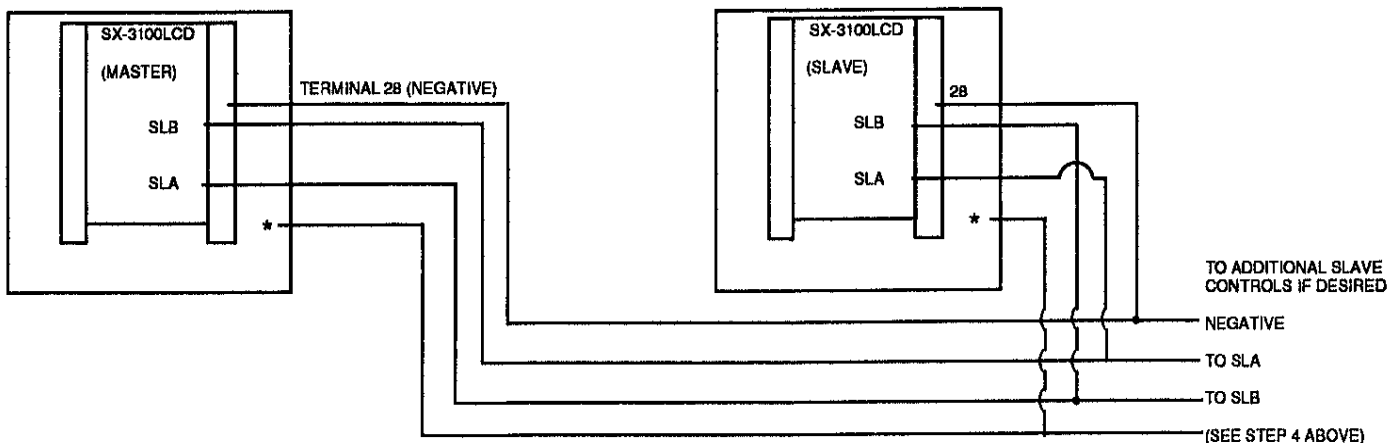

FIGURE 22 SLAVE/MASTER WIRING

## 13) SYSTEM KEY SWITCH USAGE

The system may be armed/disarmed from a maintained key switch connected across terminal 29 (+ AUX. power) and pin "SLA" located on the right side of the control board (see Figure 18). Program function 262 with a value of "1". This alternate method of system key switch usage will not require use of one of the hardwire zones although it is limited to arming and disarming. It cannot be supervised or programmed with any zone features. Function 262 will cancel arm/disarm capabilities from the control station (although a control station may be used for visual system status, shunting, and programming). The control will arm whenever the key switch contacts are open. If an attempt is made to de-activate the alarm by cutting the keyswitch wiring, the control will remain armed.

**NOTE:** This function cannot be used if the terminal SLA is to be used for configuring a slave master system.

†† Do not use slave/master configurations in U.L. installations.



## 14) EXPANDED SUBZONING

The sixteen hardware zones, regardless of type, may be subdivided and individually controlled for applications such as multi-tenant buildings, etc. Subzoning as it is referred to, is enabled by programming one or more of the first 16 user authorization codes as a subzone user code. A subzone code can disarm and re-arm any single zone, or a group of consecutive zones, provided the main control is armed. Since the subzone code actually shunts zones, the main control must be armed unless the zone(s) to be subzoned are defined as 24 hour zones. Each zone to be subzoned must also be defined as shuntable. Burglar zones that are manually shunted prior to arming can be activated (un-shunted) without disarming the system by entering an assigned subzone code. Subzones in alarm condition may be silenced by entering the subzone code but the communicator, if programmed, will still activate, and the main control will still be in alarm condition. A regular non-subzone defined user code must be entered to clear the alarm. The control will not allow a faulted subzone to be restored to service by entering the subzone code.

### • ENABLING SUBZONING

The subzone feature is enabled by programming the configuration digit of a user authorization code with a value of 8, 10, 11, 12, 13, 14, or 15. The configuration digits are programmed in function 34 through 50. See table 4.

CONFIGURATION DIGIT	SUBZONING ASSIGNED TO
8	CORRESPONDING ZONE
10	CORRESPONDING ZONE + NEXT CONSECUTIVE ZONE
11	CORRESPONDING ZONE + NEXT 2 CONSECUTIVE ZONES
12	CORRESPONDING ZONE + NEXT 3 CONSECUTIVE ZONES
13	CORRESPONDING ZONE + NEXT 4 CONSECUTIVE ZONES
14	CORRESPONDING ZONE + NEXT 5 CONSECUTIVE ZONES
15	CORRESPONDING ZONE + NEXT 6 CONSECUTIVE ZONES

TABLE 9 SUBZONING CONFIGURATION DIGIT

The chosen user code MUST correspond to the first zone number to be controlled. The same code may then be assigned to up to 6 additional consecutively numbered zones. If the consecutive zones exceed zone 16, then subzoning will automatically wrap back around to the beginning (Zone 01, then Zone 02, etc.).

**IMPORTANT:** When subzoning is enabled, the control always responds as if 16 zones are possible, whether or not the eight(8) zone expander is used. For example, if configuration digit 15 were to be assigned to code 3, then zones 03, 04, 05, 06, 07, 08, and 09 are assigned to code 3. If the eight(8) zone expander were installed in the system, zone 09 would be included. If the zone expander were not installed, only zones 3 thru 8 would be assigned. This must be kept in mind when attempting to "wrap" zones. If a configuration digit is assigned to zone from 09 thru 16 and the expander is not used, the control will still subzone the expanded zones.

### EXAMPLE OF SUBZONE "WRAPPING"

A building is divided into three (3) areas. Area 1 is zone 02 only. Area 2 is zones 03, 04, and 05. Area 3 is zones 11, 12, 13, 14, 15, 16, and 01. Note that area 3 may still be assigned as detailed below, even if the eight(8) zone expander is not used. The control will still count the zones but actually only subzone (shunt) zone 01 when user code 11 is entered.

AREA 1 User code 2	AREA 2 User code 3	AREA 3 User code 11
ZONE 02	ZONE 03 ZONE 04 ZONE 05	ZONE 11 ZONE 12 ZONE 13 ZONE 14 ZONE 15 ZONE 16 ZONE 01

TABLE 10 SUBZONING WRAP

- Program the zone definitions (Functions 51 thru 66) as required by the installation. Unless the control station is outside of the detection area, make certain that at least 1 zone of each area is programmed for entrance delay to allow entry and exit.
- Program the code for User Code 2 (Function 2). Program the configuration digit of code 2 (Function 35) with a value of "8".
- Program the code for User Code 3 (Function 3). Program the configuration digit of code 3 (Function 36) with a value of "11".
- Program the code for User Code 11 (Function 11). Program the configuration digit of code 11 (Function 44) with a value of "15".
- Program the main arm/disarm code. For this example the main code is User Code 1 (Function 1), however it could be any of the unused codes or even code 17. Program the configuration digit of code 1 with a value which allows arm or disarm.
- Arm the control using the main arm/disarm code.
- Open the delay defined zone of area 1.
- Disarm (shunt) area 1 by entering the programmed User code 2. This will allow full access to zone 2. Whenever the subzone code is entered, the control station will display zone status for eight (8) seconds and the subzoned (shunted) zones will be indicated.
- Enter User code number 2 once again to re-arm area 1. The control stations will display zone status for eight (8) seconds.  
**NOTE: If the zone(s) are not ready to re-arm, the control station will produce a two second error tone and ignore the command.**

## 15) DIGITAL COMMUNICATOR

The control has a built in communicator that can dial two (2) different 26 digit telephone numbers using either rotary or touchtone ® dialing. The report codes for all zones and transmitted conditions are programmable for each telephone number. By programming both telephone numbers and report codes identically, each telephone number can back-up the other if unsuccessful. Certain conditions may also be "split" between two different telephone numbers by programming selected report codes for each telephone number.

## 16) TELEPHONE LINE SEIZURE

When the communicator is triggered, it seizes the telephone line, thereby disconnecting the house telephones. Dial tone detection is then enabled. Once detected, rotary or touchtone ® dialing sequence begins, depending on programming of function 87 and 160. If a dial tone is not detected within 10 seconds, the communicator hangs-up for the time set in programming function 73 (factory default 3 seconds) and re-enables dial tone detection. If a dial tone is not detected within 10 seconds, the communicator will begin its dialing process anyway.

## 17) FORCE ARMING ( See PROGRAMMING THE CONTROL, Function 249)

**THIS PAGE INTENTIONALLY LEFT BLANK**

## 9. SPECIFICATIONS

### **SX-3100LCD Control Board:**

- Eight (8) two wire zones each supervised with a 2200 Ohm end-of-line resistor.
- Expandable to sixteen (16) hardwire zones with the optional SX-3104 Eight Zone Expander.
- Three (3) keypad activated emergency zones.
- Nominal current drain for board only: 80 milliamps.
- Watchdog microprocessor monitoring circuit.
- Superior six (6) stage lightning/transient protection.
- Two general purpose form "C" SPDT (5 Amp DC) relays.
- Ten (10) alarm and control outputs.
- Low battery detection monitoring @ 11.2 Volts threshold.
- Dynamic 24 hour battery load test.
- Automatic system shutdown if voltage falls below 7.5 volts.
- Operating temperature range inside the enclosure: 32 to 122 degrees Fahrenheit (0 to +50 degrees Celsius).

### **Power Supply:**

- Full 1.5 Amp regulated.
- Less than 200 millivolts AC ripple.
- Regulated 13.8 Volts DC 900 milliamps continuous output. (See Table1 for U.L. and C.S.F.M limits)
- Reverse polarity protection on battery inputs.
- Float charging circuit: 13.8 Volts DC
- Fused Outputs for Keypad power (3AG-1.5A), Auxiliary output (3AG-2.5A), and Fire (*ff*) power (3AG-2.5A).

### **Battery (S-2374):**

- Rechargeable 12 Volt 6 Amp-hour lead acid. 5 year warranty.

### **Transformer (Part #8003A-000):**

- U.L listed class II plug-in, 18 volt AC, 35 VA secondary, 120 volt 60 Hz primary.

### **Enclosure:**

- Twenty (20) gauge locking metal cabinet with two keys. Dimensions: 14" x 14" x 3.5" (356mm x 356mm x 89mm)

### **Digital Communicator:**

- Touchtone ® or Rotary (pulse) dialing. Rotary speed: 10pps, (60 % break, 40 % make).
- FCC Registration number: DLH66Y-12286-AL-E. Ringer equivalence: 0.0B.
- Transmission formats include: Slow (10 or 15 baud), fast (20 or 40 baud), Radionics superfast (30 baud) and BFSK ®.
- Reports to most major central station receivers.
- Primary and secondary phone numbers up to 26 digits.

### **Control Station (SX-3136):**

- Four (4) wire plug-in connector hookup.
- Twelve button keypad with audible and tactile feedback.
- Surface or flush mountable. Mounts to any standard single or double gang electrical box.
- Eight (8) LEDs provide total system and zone status.
- Built-in piezo sounder.
- Nominal current drain: 70 mA standby (Power, Ready to Arm, Interior on, Delay on, LEDs lighted), 96 mA in alarm.
- Up to 7 per system. (See Table1 for U.L. and C.S.F.M limits.)
- Size: 6.82" x 4.72" x 0.83" (173mm x 120mm x 21mm)
- Color: Bone white with gray labeling.

\*\* U.L. Listing pending.

\*\* California State Fire Marshall approval pending.

\*\* Canadian Department of Communications pending.

## 10. FEATURES AND ACCESSORIES

- Ready to install with a factory basic program.
  - Plug-in Circuit board for easy pre-wiring.
  - Programmable from SX-3136, SX-3130, SX-3131, SX-3132 or SX-3100ST control stations.
  - Upload/Download programming and control from a remote location using an IBM PC ® or compatible, any Hayes ® or compatible modem, and Moose Transport-PC software.
  - Seventeen (17) User Authorization codes.
  - Expanded Subzoning of 1 to 7 zones by user code.
  - Master/Slave configuration allows zone expansion and arm/disarm of multiple controls from a master control station.
  - Programmable communicator lockout of burglar defined zones to limit runaway reporting.
  - EEPROM memory retains arm/disarm status, alarm memory, and programming after total power loss or board removal.
  - Self-diagnostics with memory error detection and reporting.
  - Hardwire zones programmable as burglar, 24 hr Auxiliary "A" (fire ff), Auxiliary "B" (police), Auxiliary "C" (emergency), and communicator report only.
  - A single zone may be programmed for keyswitch arm/disarm.
  - Burglar zones may be defined as instant or delay (2 delay timers), interior or perimeter, silent instant, priority (non-shuntable), slow or fast loop response.
  - All hardwire zones may be programmed for supervisory/trouble condition latching or timed.
  - Individual or group zone shunt (bypass) from touchpad.
  - Zone force arm with full shunt, or restore when zone restores.
  - Zone auto shunt or auto restore after alarm.
  - 24 hour zones may be programmed as shuntable.
  - Programmable Timers: Entry Delay 1/2, Exit Delay, Access, Alarm Cut-off, and Delay before audible burglar output.
  - Programmable loop response of 40 msec. to 10.2 seconds.
  - Eight (8) second invalid or inactive control station timeout and 3 minute programming timeout.
  - Continuous monitoring of auxiliary and fire (ff) fuses.
  - Optional siren/bell test upon arming.
  - Courtesy "lamp" line carrier trigger output.
  - Timed or latched access (door strike) output.
  - Missing control station detection with communicator report.
  - Digital Communicator Reporting Capabilities:
    - 3 or 4 digit account codes.
    - 1 or 2 digit alarm codes.
    - Report by zone.
    - Single or 2 line extended.
    - Two separate Account codes.
    - Hexidecimal reporting.
    - Split reporting.
    - Opening or Closings by User Code.
    - Shunted zone(s) reported upon arming.
    - Exception openings by User Code.
    - Individual zone and or system restore.
    - Cancel/Abort report by User code.
    - Supervisory/trouble by zone.
    - Low battery and battery restoral.
    - AC failure and AC restoral.
    - Automatic test every 12 hours or 1 to 7 days.
    - Delay before dial.
    - Dial attempts for telephone number one and two.
    - Optional fail-to-communicate annunciation.
    - One (1) minute listen-in on Telephone number 1 or 2.
  - **SX-3100ST Security Terminal:**
    - Two line - 48 character Liquid Crystal Display.
    - Electro-luminescent blue-green backlight.
    - Adjustable intensity touchpad downlight (2 stages).
    - Four (4) wire plug-in connector hookup.
    - Built-in piezo sounder.
    - Two LEDs (ARMED and POWER).
    - Minimum current drain STANDBY: 28 milliamps. (No lights)
    - Maximum current drain in ALARM: 158 milliamps (All lights adjusted to maximum intensity.)
  - **SX-3104 8 Zone Expansion Board:** Expands the control to a total of 16 programmable hard wire zones.
  - **8785A-000 Programming Cable:** For plugging in a control station directly at the control board for programming, etc.
  - **SX-3101 Output Expansion Module ††:** Expands control outputs to include: Individual zone status, Alarm by zone, Supervisory/Trouble, Failure to communicate, Ground start trigger, and audio listen-in trigger.
  - **SX-3103 Three Zone and BCD Interface ††:** Allows hard wiring open circuit devices to activate keypad emergency zones and compatible BCD keypads to operate the control.
  - **SX-3102 Eight Zone LED Display ††:** A surface mountable zone status display for use with a SX-3101.
  - **2575A-000 Low Battery Cutoff Module:** Automatically disconnects battery to prevent deep discharge if battery voltage drops below 7.5 volts.
- †† Not a U.L. Listed device.
- NuTone and NuTech are registered trademarks of NuTone, Inc.  
 TRANSPORT-PC is a trademark of Moose Products, Inc.  
 IBM ® is a registered trademark of International Business Machines, Inc.  
 Hayes ® is a registered trademark of Hayes Microcomputer Products, Inc.  
 Touchtone is a registered trademark of American Telephone & Telegraph, Inc.  
 BFSK ® is a registered trademark of Radionics, Inc.
- Made in USA.

# NOTES

Product specifications subject to change without notice

# NuTone Inc.

**Scovill**

Madison & Red Banks Rds.  
Cincinnati, Ohio 45227

Printed in U.S.A. 4/89  
Part No. 43470  
L7420