

Linear

A NORTEK COMPANY

MODELS 5040A & 50S40A

Passive Infrared Intrusion Detector

Installation Instructions

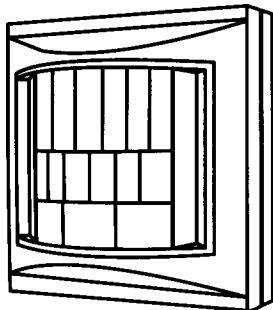

Linear Corporation
(619) 438-7000 • FAX (619) 438-7043
USA (800) 421-1587 & (800) 392-0123

COMPONENT LOCATIONS

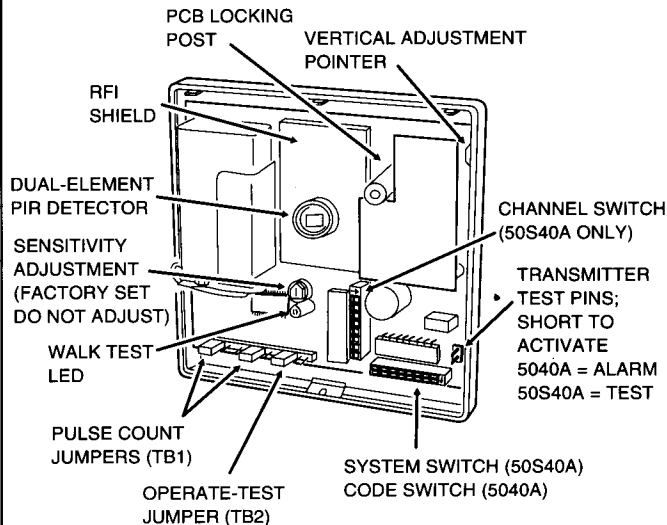

DIMENSIONS

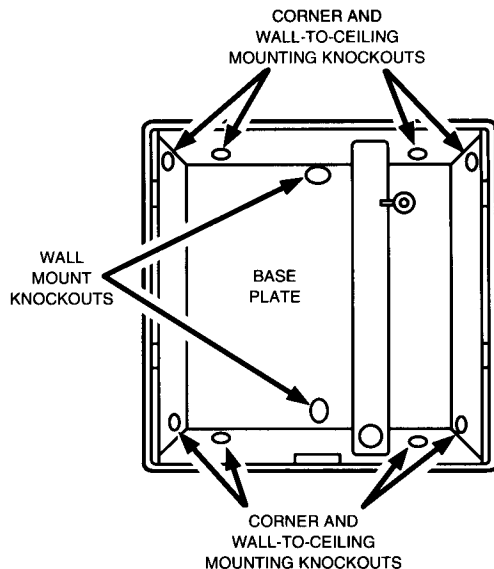
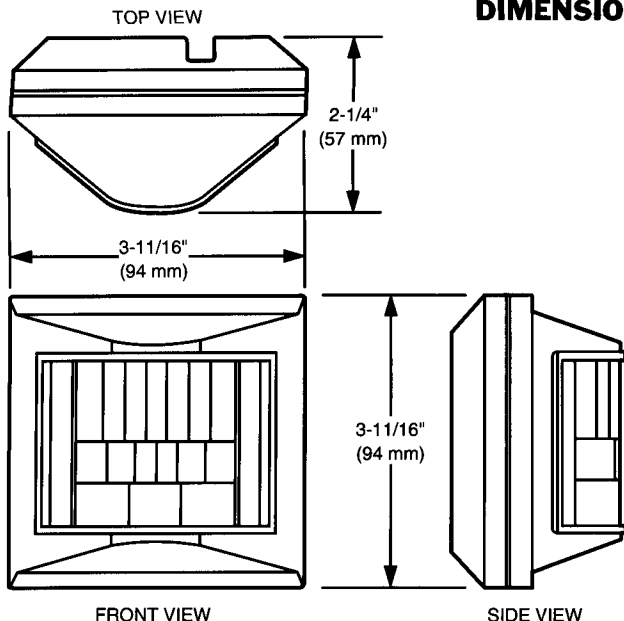

DETECTION PATTERNS

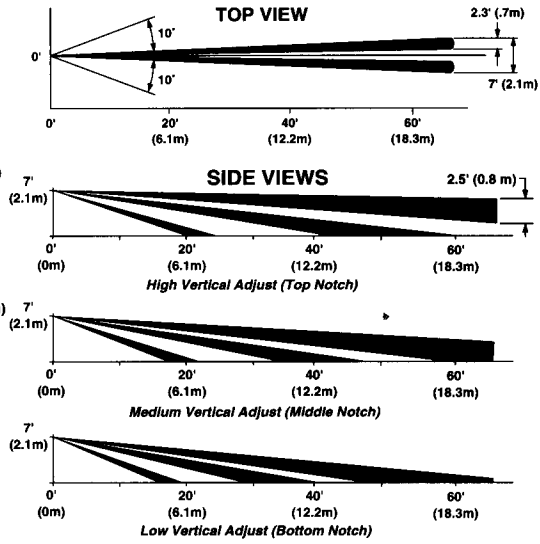
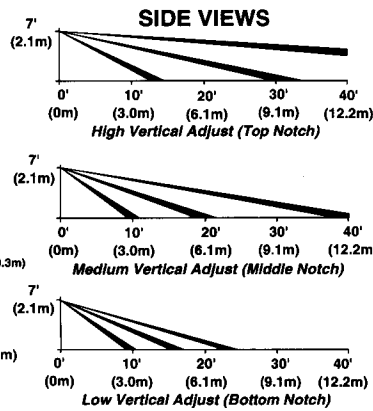
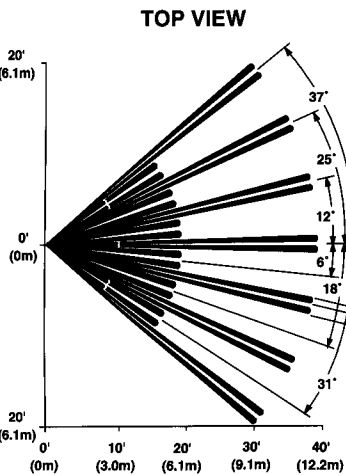

HIGH DENSITY LENS (INSTALLED)

LONG RANGE LENS (IN BOX)

INSTALLATION TIPS

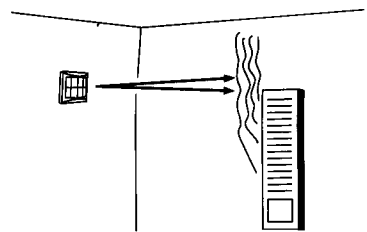

Do not point at objects that change temperature.

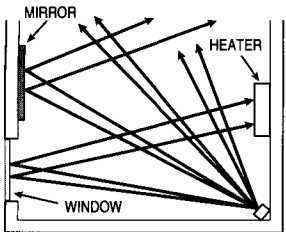

Reflective surfaces will bounce pattern.

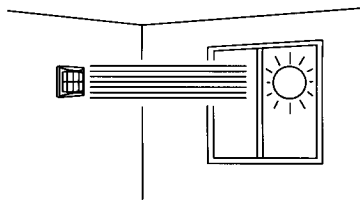

Direct sunlight may damage optics or trigger PIR.

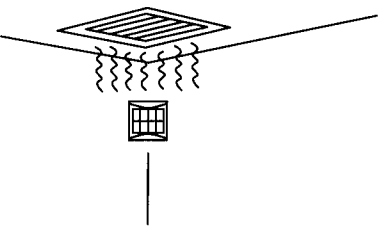

Drafts blowing on case may trigger PIR.

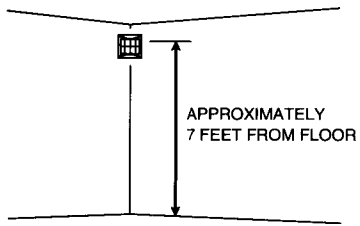

Mount PIR 6-7.5 feet above floor.

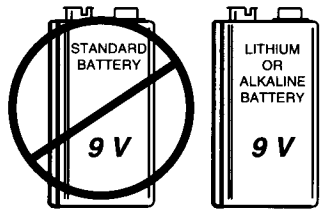

NOTE: For longer life use a lithium battery.
Use alkaline or lithium batteries only.

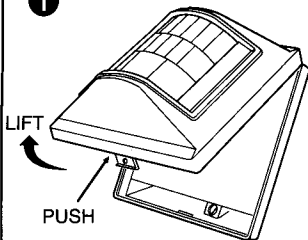
1

Remove the top cover by pressing in on the bottom edge and swinging the cover up. A case cover locking screw is supplied along with mounting screws in a bag in the packing box. After installation, secure the case cover by inserting the case screw.

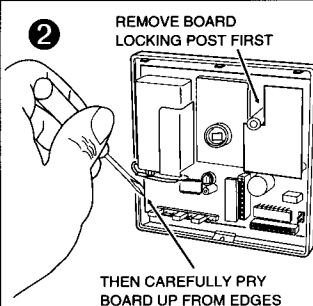
2

Remove the PCB locking post. Remove the circuit board from the base by prying up from the side with a flat blade screwdriver.
CAUTION: DO NOT PULL ON THE CIRCUIT COMPONENTS TO REMOVE THE BOARD!

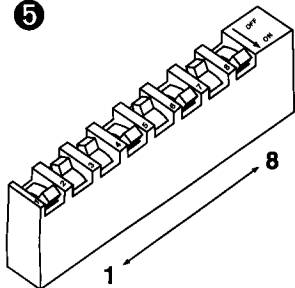
5

Set the digital code switch(es) to the appropriate code as defined in the receiver's instructions (50S40A has two switches). In the example shown, keys 1, 4, 6, and 8 are ON (towards arrow). **NOTE: Pushing switch keys in direction of arrow printed on switch is always ON.** Short test pins to test transmitter.

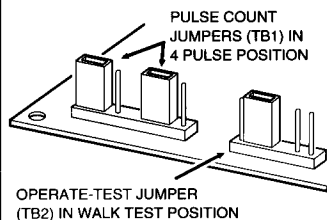
6

Place the pulse count jumpers (TB1) in the 4 pulse position and the operate-test jumper (TB2) in the walk test position (as shown). *NOTE: The pattern test position (far right on TB2) can be used for precise pattern location (optional).*

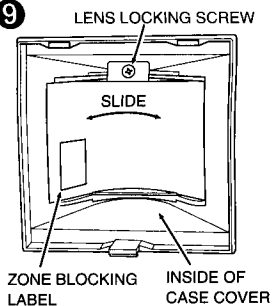
9

To adjust the detection pattern horizontally, remove the cover, loosen the lens locking screw, and slide the lens left or right. Re-tighten screw, replace cover and repeat walk test. Adhesive stick-on zone blocking labels are included for masking portions of the lens. Apply them to the inside of the lens if needed.

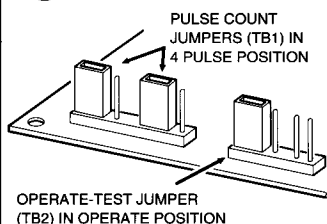
10

Place the operate-test jumper in the operate position (as shown). **DO NOT LEAVE THE JUMPER IN THE WALK OR PATTERN TEST POSITIONS AFTER INSTALLATION.** If the LED blinks in the operate mode, the battery is low. *NOTE: To cause a transmission, wait at least 5 minutes before walking in front of the unit.*

INTERCHANGING LENSES

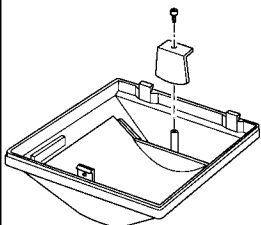

REMOVE LOCKING PLATE

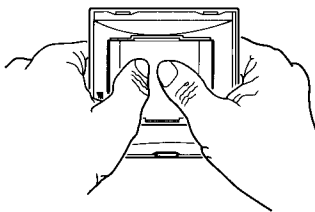

POP OUT OLD LENS FROM INSIDE

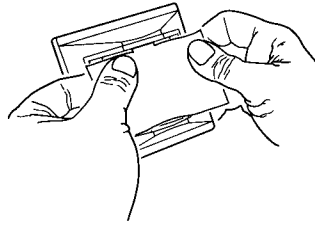

PUT OTHER LENS IN FROM THE FRONT

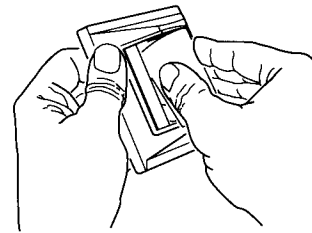

FOLD LENS INTO EDGES TO FIT, THEN REPLACE LOCKING PLATE AND SCREW

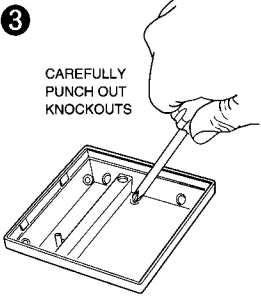

Punch out the desired knockouts with a Phillips screwdriver while the base is on a piece of carpet. Referring to the Installation Tips on the reverse side of these instructions, mount the base to the wall with the locking tab slot down.

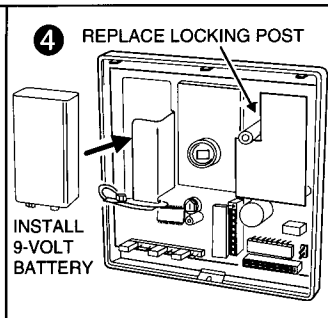

Snap the circuit board into the base and replace the PCB locking post. Align the vertical adjustment pointer to mid-position and tighten the PCB locking post. Install a 9-volt *alkaline* or *lithium* battery. **Do not use a carbon-zinc battery!**

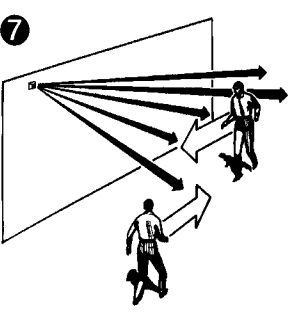

Replace the front cover and walk test unit by moving across the detection pattern from both sides. *NOTE: The transmitter will send a signal each time the LED lights during walk test only (not during pattern test). When in operate, the transmitter will only send a signal after the detector has seen no motion for 2-3 minutes.*

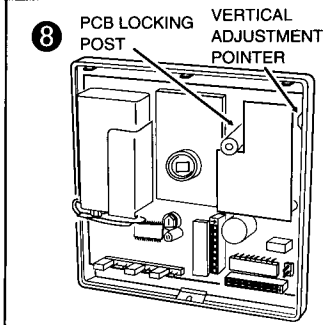

To adjust the detection pattern vertically, remove the cover, loosen the PCB locking post and slide the PCB up or down. Re-tighten post, replace cover and repeat walk test.

SPECIFICATIONS

- COVERAGE:** High Density: 40' x 40' (12.2 x 12.2 m)
Long Range: 70' x 7' (21.3 x 2.1 m)
- NUMBER OF ZONES:** High Density: 16 Twin Beams
Long Range: 3 Twin Beams
- DETECTOR:** Dual-element pyro-electric
- CAPTURE RATE:** .5 to 15 feet/second
(.2 to 5 meter/second)
- VISUAL INDICATOR:** Extra bright LED blinks in walk test
LED also blinks during low battery
- WARMUP TIME:** 3 Minutes
- SIGNAL PROCESSING:** Pulse Count of 2, 3, 4, or 5
- VOLTAGE OPERATING TEMPERATURE:** 9-volt battery
- TEMPERATURE:** Battery limited
- MAXIMUM HUMIDITY:** 95%
- RFI IMMUNITY:** Sensor and critical circuitry shielded for maximum immunity
- ZONE BLOCK:** Die-cut adhesive stick-ons
- SIZE:** 1.163" x 5.30" (2.95 cm x 13.46 cm)
- LENS:** Interchangeable High Density and Long Range Fresnel type
- COLOR:** Egg Shell White
- MOUNTING:** Wall or Corner

LINEAR LIMITED WARRANTY

This Linear product is warranted against defects in material and workmanship for twenty four (24) months. The Warranty Expiration Date is labeled on the product. **This warranty extends only to wholesale customers** who buy direct from Linear or through Linear's normal distribution channels. **Linear does not warrant this product to consumers.** Consumers should inquire from their selling dealer as to the nature of the dealer's warranty, if any. **There are no obligations or liabilities on the part of Linear Corporation for consequential damages arising out of or in connection with use or performance of this product or other indirect damages with respect to loss of property, revenue, or profit, or cost of removal, installation, or reinstallation.** All implied warranties, including implied warranties for merchantability and implied warranties for fitness, are valid only until Warranty Expiration Date as labeled on the product. **This Linear Corporation Warranty is in lieu of all other warranties express or implied.**

For warranty service on Linear equipment return product, at sender's expense to:
Linear Corporation 2580 Pioneer Avenue, Suite C, Vista, CA 92083 Attention: Repairs Department

IMPORTANT !!!

- Linear radio controls provide a reliable communications link and fill an important need in portable wireless signaling. However, there are some limitations which must be observed.
- * For U.S. installations only: The radios are required to comply with FCC Rules and Regulations as Part 15 devices. As such, they have limited transmitter power and therefore limited range.
 - * A receiver cannot respond to more than one transmitted signal at a time and may be blocked by radio signals that occur on or near their operating frequencies, regardless of code settings.
 - * Changes or modifications to the device may void FCC compliance.
 - * Infrequently used radio links should be tested regularly to protect against undetected interference or fault.
 - * A general knowledge of radio and its vagaries should be gained prior to acting as a wholesale distributor or dealer, and these facts should be communicated to the ultimate users.