

---

# Content

---

---

## Section 1 System Overview ..... 1-1

---

1.1	Features .....	1-1
	Hardware: .....	1-1
	Software: .....	1-2
1.2	Optional Accessories .....	1-2
1.3	Formats Compatible with the 9800 .....	1-3
1.4	9800 Supported SIA Digital I-III Levels .....	1-4
1.5	How to Use this Manual .....	1-5
1.6	Terminology .....	1-5
1.7	What's in the Box .....	1-6
1.8	How to Contact Silent Knight .....	1-6

## Section 2 Agency Requirements ..... 2-1

---

2.1	Telephone Requirements .....	2-1
2.2	FCC Warning .....	2-1
2.3	UL Requirements .....	2-2
	2.3.1 Hardware Requirements .....	2-2
	2.3.2 Operational Requirements .....	2-2
	2.3.3 Programming Requirements .....	2-3

## Section 3 Installation ..... 3-1

---

3.1	Environmental specifications .....	3-1
3.2	Electrical Specifications .....	3-1
3.3	Overview .....	3-2
3.4	Rack Mounting .....	3-3
3.5	Line Card Installation .....	3-5
3.6	Removing Line Cards .....	3-6
3.7	Telephone Line Connection .....	3-7
3.8	Parallel Printer Connection .....	3-7
	3.8.1 Printer Cable Pin-Outs .....	3-8
	3.8.2 Com Ports 1 & 2 .....	3-9
	3.8.3 Remote Alert Output .....	3-9
3.9	AC Power Cord Connection .....	3-10
	3.9.1 Switching to a 230 VAC Power Supply .....	3-10
	3.9.2 How to Verify Earth Ground .....	3-12
3.10	Battery Connection .....	3-13
3.11	Automation Computer Connection .....	3-14
	3.11.1 Computer Port Baud Rate Selection .....	3-14

## Section 4 Operation ..... 4-1

---

4.1	Touchpad Function Buttons .....	4-1
4.2	Displays .....	4-3
4.2.1	LED Displays .....	4-3
4.2.2	LCD Status Display .....	4-3
4.2.2.1	Adjusting LCD Contrast .....	4-4
4.2.2.2	LCD Abbreviations .....	4-5
4.3	Initial System Power Up .....	4-6
4.4	Log On / Log Off .....	4-7
4.4.1	Installer Profile .....	4-7
4.4.2	Operator Profile .....	4-7
4.4.3	Default User Codes .....	4-8
4.4.4	How to log on the system. ....	4-8
4.4.5	How to log off the system. ....	4-9
4.5	Modes of Operation .....	4-10
4.5.1	Normal Mode .....	4-10
4.5.1.1	Manual Operation .....	4-10
	How to Manually Acknowledge Calls: .....	4-10
4.5.1.2	Automatic Operation .....	4-10
4.5.1.3	Log Only .....	4-10
4.5.2	Program Mode .....	4-10
4.6	Main Menu .....	4-11
4.6.1	How to display the Main Menu .....	4-11
4.6.2	How to Maneuver Through Main Menu .....	4-12
4.6.3	Call History .....	4-13
4.6.4	System History .....	4-13
4.6.5	System Info .....	4-14
4.6.6	Set Time & Date .....	4-15
4.6.7	System Restart .....	4-16
4.6.8	Printer Menu .....	4-17
4.6.8.1	Print Report .....	4-18
	How to Print Call History .....	4-18
	How to Print System History .....	4-19
	How to Print System Configuration .....	4-20
	How to Print a Test Page .....	4-21
4.6.8.2	Edit Event Format .....	4-21
4.6.8.3	Configure Printer .....	4-23
4.6.9	Program Menu .....	4-24
4.6.10	Diagnostics Menu .....	4-24
4.6.10.1	Phantom Menu .....	4-25
4.6.10.2	Message Que .....	4-26
4.6.10.3	Event Log .....	4-26
4.6.10.4	Format .....	4-27
4.6.10.5	LC Debug Mode .....	4-27
4.7	Listen-In and Hang Up .....	4-28
4.7.1	Manual (Common) Listen-In Operation .....	4-28
4.7.2	PBX Operation .....	4-29
4.8	Testing the System .....	4-29

## Section 5

### Programming ..... 5-1

---

5.1	How to Enter Program Mode .....	5-1
5.1.1	Programming Fields .....	5-1
5.1.2	How to Maneuver Around in Program Mode .....	5-2
5.2	Programming Choices .....	5-2
5.3	General Options .....	5-3
5.3.1	Operation Mode .....	5-7
5.3.1.1	How to change the operation mode .....	5-8
5.3.2	Display Options .....	5-9
5.3.2.1	How to Change Language Display .....	5-10
5.3.2.2	How to Change Time Format Display .....	5-10
5.3.2.3	How to Change Date Format Display .....	5-11
5.3.2.4	How to Turn “On” or “Off” Daylight Savings. ....	5-11
5.3.2.5	How to Edit ITI Options .....	5-12
5.3.2.6	How to Set Sorted Events .....	5-13
5.3.2.7	How to Set Hold Last Event .....	5-13
5.3.3	Communications .....	5-14
5.3.3.1	How to Set Up Port Function .....	5-18
5.3.3.2	How to set Com Port 1 Parameters .....	5-18
5.3.3.3	How to Set Com Port 2 Parameters .....	5-19
5.3.3.4	How to Edit Init String (Com 1, Com 2, and Parallel Port) .....	5-20
	To clear an init string: .....	5-21
5.3.3.5	How to Set Automation Communication .....	5-21
	How to Set the Format .....	5-21
	How Enable or Disable Hex Mode .....	5-22
	How Enable or Disable Heartbeat .....	5-22
	Time (Period of Heartbeat) .....	5-23
	Ack Time (Acknowledge Time) .....	5-24
	ITI Options (Only Visible if ITI Gen or ITIComp Formats are Chosen) .....	5-25
	Log Recs (For ITI Formats): .....	5-26
	XID (Extended ID for ITI Panels): .....	5-26
	SupCh (Supervisory Character): .....	5-26
	NoData (No Data Character for Log Record): .....	5-26
5.3.3.6	How to Configure the On-board Annunciator Outputs .....	5-27
5.3.3.7	How to Configure the Auxiliary Relay Outputs .....	5-28
5.3.4	System Options .....	5-29
5.3.4.1	How to Change Backup Battery Setting .....	5-30
	To Exit: .....	5-30
5.3.4.2	How to Set the Receiver ID Number .....	5-30
	To Exit: .....	5-30
5.3.4.3	How to Set the Normal State of the Auxiliary Relay Contact .....	5-31
	To Exit: .....	5-31
5.3.5	Message Queue Options .....	5-31
5.3.5.1	Set the Message Queue Warning On level .....	5-32
	To Exit: .....	5-32
5.3.5.2	Set the Message Queue Warning Off Level .....	5-32
	To Exit: .....	5-32
5.3.5.3	Set the maximum Buffer Limit .....	5-33
	To Exit: .....	5-33
5.4	Line Card Menu .....	5-33

5.4.1	Add Line Card .....	5-37
5.4.2	Edit Line Card .....	5-37
5.4.2.1	Handshake Sequence .....	5-39
	To Change the Handshake Sequence Number: .....	5-40
	To Change the Format Group: .....	5-40
	To Change the Handshake Delay Time: .....	5-41
	To Change the Handshake Duration Time: .....	5-41
	To Change the Maximum Handshake Wait Time: .....	5-42
	To Change the Acknowledgment Tone Duration Time: .....	5-42
5.4.2.2	Line Options .....	5-43
	How to Set the Line Card for a Direct Line (Dedicated Line): .....	5-43
	To Change the Number of Rings Follow These Steps: .....	5-44
	To Change the Ring On Time: .....	5-44
	To Change the Ring Off Time: .....	5-45
	To Change the Ring Threshold Voltage: .....	5-45
	To Change the Phone Line Sample Rate: .....	5-46
5.4.2.3	Listen-In .....	5-47
	To Change the Listen Mode: .....	5-47
	To Change the PBX String: .....	5-48
	To Change the Listen-In Timeout: .....	5-49
	To Edit the Listen-In accounts Lists: .....	5-49
	To Add a Listen In Account .....	5-50
	To Edit a Listen In Account .....	5-50
	To Clear a Listen In Account .....	5-50
5.4.2.4	Trap List .....	5-51
	To Add a Trap Account .....	5-51
	To Edit a Trap Account .....	5-51
	To Clear a Trap Account .....	5-52
5.4.2.5	Misc. Line Opt. ....	5-53
	To Change the Echo Suppress Setting: .....	5-53
	How to Set Caller ID .....	5-54
	To Change the Billing Delay Setting: .....	5-54
	To Change the Hunt Group: .....	5-55
5.4.2.6	ITI Options Menu .....	5-55
	ITI SCode Menu: .....	5-57
	To Set Date/Time Flag: .....	5-59
	To Enable or Disable ITI 300 Baud Negotiation: .....	5-59
5.4.3	Copy Line Cards .....	5-59
5.4.3.1	To Program the Default Settings Into a Line Card .....	5-59
5.4.3.2	Copy the Programming of an Existing Line Card to Another .....	5-60
5.4.4	Clear Line Card .....	5-61
	To Clear or Delete a Line Card Form the Receiver Follow These Steps: .....	5-61
5.4.5	View Line Cards .....	5-62
5.5	User List .....	5-63
5.5.1	Adding a User .....	5-64
5.5.2	Editing a User .....	5-65
5.5.3	Clearing a User Out of the Receiver .....	5-67

## **Section 6**

### **Compatible Reporting Formats .....** 6-1

---

6.1	Formats By Communication Group. ....	6-1
6.2	Format Numbers Used In Printer Output .....	6-3

## Section 7 Troubleshooting ..... 7-1

---

7.1	Error Messages .....	7-1
7.2	Troubleshooting Process .....	7-5
7.2.1	Removing the Power Supply/Mother Board Assembly .....	7-6
7.2.2	Replacing the Mother Board/Power Supply Assembly .....	7-7
7.3	Safe Mode .....	7-7
7.4	Updating the Receiver Software .....	7-8

## Section 8 Automation Communication Formats ..... 8-1

---

8.1	Introduction .....	8-1
8.1.1	Conventions Observed In This Section .....	8-1
8.2	Silent Knight 9000 Protocol .....	8-2
8.2.1	Data String Description And Special Characters .....	8-2
8.2.2	Calls From Panels .....	8-4
8.2.3	Long Calls .....	8-5
8.2.4	Bad Data .....	8-5
8.2.5	Good Data with Bad Data .....	8-5
8.2.6	Validation Byte (V-Byte) .....	8-6
8.2.7	System Messages .....	8-6
8.2.8	Communication from a Computer to the 9800 .....	8-7
8.2.8.1	ACKing And NACKing Data .....	8-7
8.2.8.2	Link Test .....	8-8
8.3	SIA CIS (Computer Interface Standard) .....	8-9
8.3.1	Data String Description And Special Characters .....	8-9
8.3.2	Basic Message Format .....	8-11
8.3.3	Modifier Codes .....	8-12
8.3.4	Long Calls .....	8-13
8.3.5	System Status Messages .....	8-14
8.3.6	Heart Beat .....	8-15
8.3.7	Communication from a Computer to the 9800 .....	8-16
8.3.7.1	ACKing and NACKing Data .....	8-16
8.3.7.2	Link Test .....	8-17
8.4	ITI Generic Computer Format .....	8-18
8.4.1	Convention Used In This Section .....	8-18
8.4.2	Report Record .....	8-18
8.4.2.1	Control Panel Type and Zone Attribution Byte .....	8-19
8.4.2.2	Extended Panel ID Codes .....	8-20
8.4.2.3	Alarm Codes .....	8-21
8.4.3	Log Record .....	8-22
8.4.4	Test Record .....	8-22
8.4.5	OKAY Record .....	8-23
8.4.6	ACKing and NACKing Data .....	8-23
8.5	ITI Computer Interface Format .....	8-24
8.5.1	Convention Used In This Section .....	8-24
8.5.2	General Record Structure .....	8-24
8.5.3	Report Record .....	8-25
8.5.3.1	Information Field Identifiers .....	8-27

8.5.3.2	Panel Type Characters .....	8-28
8.5.3.3	Condition Codes .....	8-29
8.5.4	Test Record .....	8-29
8.5.5	Supervisory Record .....	8-30
8.5.6	Log Records .....	8-30
8.5.7	Checksum/Control Field .....	8-31
8.6	SIA 2000 .....	8-31
8.7	SK EXP (Silent Knight Expanded) .....	8-32
8.7.1	SKE Header Block .....	8-32
Example:	.....	8-32
8.7.2	Call Message Block .....	8-33
Example:	.....	8-33
8.7.2.1	Dialer Format .....	8-34
8.7.2.2	Panel Data .....	8-35
Example:	.....	8-36
8.7.2.3	Listen-in Indicator .....	8-37
Example:	.....	8-37
8.7.2.4	Trap Account Indicator .....	8-38
Example:	.....	8-38
8.7.2.5	Long Call Indicator .....	8-38
8.7.2.6	Bad Data Field Indicator .....	8-39
Example:	.....	8-39
8.7.3	System Message Block .....	8-39
Example:	.....	8-39
8.7.3.1	System Messages .....	8-41
8.7.4	Heart Beat Message Block .....	8-42
Example:	.....	8-42
8.7.5	Validation Byte (V-Byte) .....	8-42
8.7.6	ACKing and NACKing Data .....	8-43
8.7.7	Commands Initiated by the Automation Computer .....	8-44
8.7.7.1	Remote Log-on/Log-off .....	8-45
To Log-in:	.....	8-45
To Log-off:	.....	8-46
8.7.7.2	Force Hang-up Request .....	8-46
To Force Hang-up:	.....	8-46
8.7.7.3	Add or Delete a Listen-in Account .....	8-47
To Add a Listen-in Account:	.....	8-47
To Delete a Listen-in Account:	.....	8-47
8.7.7.4	Common Listen-in Extend/End Request .....	8-48
To Extend Listen-in:	.....	8-48
To End a Listen-in Session:	.....	8-48
8.7.7.5	PBX Listen-in String .....	8-49
To Create or Edit PBX String:	.....	8-49
8.7.7.6	Add or Delete a Trap Account .....	8-50
To Add a Trap Account:	.....	8-50
To Delete a Trap Account:	.....	8-50
8.7.7.7	Link Test Request .....	8-51
8.8	US ASCII Character Code .....	8-51

<b>Appendix A</b>	
<b>Programming Quick Chart .....</b>	<b>A-1</b>

<b>Index .....</b>	<b>Index-1</b>
--------------------	----------------

---

# List of Tables

---

---

## Section 1

<b>System Overview</b> .....	1-1
------------------------------	-----

---

1.1 Features .....	1-1
1.2 Optional Accessories .....	1-2
<b>Table 1-1:</b> Optional Accessories for the 9800 receiver .....	1-2
1.3 Formats Compatible with the 9800 .....	1-3
<b>Table 1-2:</b> Formats compatible with the 9800 .....	1-3
1.4 9800 Supported SIA Digital I-III Levels .....	1-4
<b>Table 1-3:</b> 9800 and SIA Levels I-III comparison .....	1-4
1.5 How to Use this Manual .....	1-5
1.6 Terminology .....	1-5
1.7 What's in the Box .....	1-6
1.8 How to Contact Silent Knight .....	1-6

## Section 2

<b>Agency Requirements</b> .....	2-1
----------------------------------	-----

---

2.1 Telephone Requirements .....	2-1
2.2 FCC Warning .....	2-1
2.3 UL Requirements .....	2-2

## Section 3

<b>Installation</b> .....	3-1
---------------------------	-----

---

3.1 Environmental specifications .....	3-1
3.2 Electrical Specifications .....	3-1
3.3 Overview .....	3-2
3.4 Rack Mounting .....	3-3
3.5 Line Card Installation .....	3-5
3.6 Removing Line Cards .....	3-6
3.7 Telephone Line Connection .....	3-7
3.8 Parallel Printer Connection .....	3-7
<b>Table 3-1:</b> External Printer Cable Pin Description .....	3-8
3.9 AC Power Cord Connection .....	3-10
3.10 Battery Connection .....	3-13
3.11 Automation Computer Connection .....	3-14

**Section 4**  
**Operation** ..... 4-1

---

4.1 Touchpad Function Buttons ..... 4-1  
**Table 4-1:** Touchpad Buttons Description ..... 4-2

4.2 Displays ..... 4-3  
**Table 4-2:** LED Description ..... 4-3  
**Table 4-3:** LCD and Printer Abbreviations ..... 4-5

4.3 Initial System Power Up ..... 4-6

4.4 Log On / Log Off ..... 4-7  
**Table 4-4:** Main Menu Option Items by Profile ..... 4-7  
**Table 4-5:** Default User Codes ..... 4-8

4.5 Modes of Operation ..... 4-10

4.6 Main Menu ..... 4-11  
**Table 4-6:** Printer Menu Choices ..... 4-17  
**Table 4-7:** Event Format Choices and Meaning ..... 4-22  
**Table 4-8:** Phantom Signals Formats List ..... 4-25

4.7 Listen-In and Hang Up ..... 4-28

4.8 Testing the System ..... 4-29

**Section 5**  
**Programming** ..... 5-1

---

5.1 How to Enter Program Mode ..... 5-1  
**Table 5-1:** Types of Programming Fields ..... 5-1

5.2 Programming Choices ..... 5-2

5.3 General Options ..... 5-3  
**Table 5-2:** General Options Items and Description ..... 5-4  
**Table 5-3:** Operation Mode Choices and Descriptions ..... 5-7  
**Table 5-4:** Display Options and Descriptions ..... 5-9  
**Table 5-5:** Communications Options and Description ..... 5-14  
**Table 5-6:** Initialization String Characters ..... 5-20  
**Table 5-7:** ITI Automation Format Options ..... 5-25  
**Table 5-8:** On-board Annunciator and Auxiliary Relay Options ..... 5-27  
**Table 5-9:** System Options ..... 5-29

5.4 Line Card Menu ..... 5-33  
**Table 5-10:** Line Card Menu Options ..... 5-34  
**Table 5-11:** Edit Line Card List Items and Description ..... 5-38  
**Table 5-12:** Valid Programmable String Characters ..... 5-48  
**Table 5-13:** Account Characters ..... 5-50  
**Table 5-14:** ITI Options Menu Items ..... 5-56  
**Table 5-15:** ITI SCode (Security Code) Options ..... 5-58

5.5 User List ..... 5-63  
**Table 5-16:** User List Menu Items and Steps ..... 5-63  
**Table 5-17:** Available Characters ..... 5-64



## Section 6 Compatible Reporting Formats ..... 6-1

---

6.1	Formats By Communication Group. ....	6-1
	<b>Table 6-1:</b> Formats compatible with the 9800 .....	6-1
6.2	Format Numbers Used In Printer Output .....	6-3
	<b>Table 6-2:</b> Formats By Report Number .....	6-3

## Section 7 Troubleshooting ..... 7-1

---

7.1	Error Messages .....	7-1
	<b>Table 7-1:</b> Error Messages .....	7-1
7.2	Troubleshooting Process .....	7-5
7.3	Safe Mode .....	7-7
7.4	Updating the Receiver Software .....	7-8

## Section 8 Automation Communication Formats ..... 8-1

---

8.1	Introduction .....	8-1
8.2	Silent Knight 9000 Protocol .....	8-2
	<b>Table 8-1:</b> Data String Description .....	8-2
	<b>Table 8-2:</b> Special Characters Used in the Protocol .....	8-3
	<b>Table 8-3:</b> System Messages .....	8-7
8.3	SIA CIS (Computer Interface Standard) .....	8-9
	<b>Table 8-4:</b> Data String Description .....	8-9
	<b>Table 8-5:</b> Special Characters .....	8-10
	<b>Table 8-6:</b> Modifier Codes Used With The 9800 .....	8-12
	<b>Table 8-7:</b> System Status Messages .....	8-15
8.4	ITI Generic Computer Format .....	8-18
	<b>Table 8-8:</b> Number and ITI Digit Equivalent .....	8-18
	<b>Table 8-9:</b> Report Record Components .....	8-18
	<b>Table 8-10:</b> Upper Nibble Description .....	8-19
	<b>Table 8-11:</b> Lower Nibble Description .....	8-19
	<b>Table 8-12:</b> Extended Panel ID Codes (XID) .....	8-20
	<b>Table 8-13:</b> Alarm Code and Description .....	8-21
	<b>Table 8-14:</b> Log Record Components and Description .....	8-22
	<b>Table 8-15:</b> Test Record Components and Description .....	8-22
	<b>Table 8-16:</b> Okay Record Components and Description .....	8-23
8.5	ITI Computer Interface Format .....	8-24
	<b>Table 8-17:</b> Number and ITI Digit Equivalent .....	8-24
	<b>Table 8-18:</b> Type of Record Identifiers .....	8-24
	<b>Table 8-19:</b> Record Components .....	8-25
	<b>Table 8-20:</b> Report Record Components and Description .....	8-26
	<b>Table 8-21:</b> Information Field Identifiers .....	8-27
	<b>Table 8-22:</b> Panel Type Characters .....	8-28
	<b>Table 8-23:</b> Panel Type Characters (Continued) .....	8-28
	<b>Table 8-24:</b> Condition Codes and Descriptions .....	8-29

	<b>Table 8-25:</b> Condition Codes and Descriptions .....	8-29
	<b>Table 8-26:</b> Test Record Information Fields and Descriptions .....	8-29
	<b>Table 8-27:</b> Log Record Information Fields And Descriptions .....	8-30
8.6	SIA 2000 .....	8-31
	<b>Table 8-28:</b> Checksum Verification Process .....	8-31
8.7	SK EXP (Silent Knight Expanded) .....	8-32
	<b>Table 8-29:</b> SKE Header Block Components Description .....	8-32
	<b>Table 8-30:</b> Call Message Components and Description .....	8-33
	<b>Table 8-31:</b> Dialer Format Types By Code .....	8-34
	<b>Table 8-32:</b> Panel Data Identifiers and Descriptions .....	8-35
	<b>Table 8-33:</b> Call Message Components .....	8-36
	<b>Table 8-34:</b> Call Message With Listen-in Data .....	8-37
	<b>Table 8-35:</b> Trap Account Indicator Components .....	8-38
	<b>Table 8-36:</b> Bad Data Field Indicator Components .....	8-39
	<b>Table 8-37:</b> System Message Components .....	8-40
	<b>Table 8-38:</b> System Messages .....	8-41
	<b>Table 8-39:</b> Link Test Components .....	8-42
	<b>Table 8-40:</b> Response Messages by the 9800 Receiver .....	8-44
	<b>Table 8-41:</b> Command Requests by Identifiers .....	8-45
	<b>Table 8-42:</b> Log-in Request Components .....	8-45
	<b>Table 8-43:</b> Log-off Request Components .....	8-46
	<b>Table 8-44:</b> Force Hang-Up Request Components .....	8-46
	<b>Table 8-45:</b> Add Listen-in Account Request Components .....	8-47
	<b>Table 8-46:</b> Delete a Listen-in Account Request Components .....	8-47
	<b>Table 8-47:</b> Extend Listen-in Period Request Components .....	8-48
	<b>Table 8-48:</b> Extend Listen-in Period Request Components .....	8-48
	<b>Table 8-49:</b> Delete a Listen-in Account Request Components .....	8-49
	<b>Table 8-50:</b> Add Listen-in Account Request Components .....	8-50
	<b>Table 8-51:</b> Delete a Listen-in Account Request Components .....	8-50
8.8	US ASCII Character Code .....	8-51
	<b>Table 8-52:</b> US ASCII Character Code .....	8-51

## Appendix A

<b>Programming Quick Chart</b> .....	A-1
--------------------------------------	-----

<b>Table A-1:</b> Programming Quick Chart .....	A-1
---	-----

<b>Index</b> .....	Index-1
--------------------	---------

---

# Section 1

## System Overview

---

---

This manual describes installation, operation, and programming of the Model 9800 Central Station Receiver. The 9800 can be used as a desk-top receiver, however it must be rack-mounted for UL listed installations. This section will list features, optional accessories, compatible formats, and SIA options supported. This section also contains conventions held throughout the manual, terminology relevant to this product, and other information.

### 1.1 Features

---

#### Hardware:

- Supports both 120 and 240 VAC installations at 60 and 50Hz operation.
- External annunciation with auxiliary Form C dry contact relay. (Programmable)
- On-board PZT alert. (Programmable.)
- 1 parallel port.
- 2 serial ports.
- 2 rear SBUS connectors.
- Modular configuration for easy replacement and repair.
- 4 line LCD Display with 20 characters for each line.
- On-board touchpad for manual operation and programming.
- LEDs to indicate system operations.
- Rack mountable design.
- One line card will communicate with all supported formats.
- Supports up to 12 line cards which operate independent of each other.
- Line card parameters are stored on the MCPUC for faster removal and replacement.
- Line cards support Caller ID and Caller Name Delivery.
- Line cards are individually programmable for format priority and ring parameters.
- Line cards support direct connect phone lines monitoring.

**Software:**

- Programmable display options for time and date information.
- View or print the history information by priority or by call or by event.
- Two user profiles to control user access to the receiver.
- Supports up to 40 users.
- Listen-in and trap accounts support wild card variables. Up to 20 accounts available per line card. (20 for listen-in and 20 for trap accounts.)
- Listen-in selectable for direct, hook flash, or PBX phone system.
- Programmable port configuration for automation, printer and backup support.
- 500 event history buffer.

## 1.2 Optional Accessories

---

The following accessories for the Model 9800 receiver are available from Silent Knight Sales Department unless otherwise indicated. You can contact Silent Knight Sales Department by phone or by mail. The Sales Department’s toll free and local numbers are 800-446-6444 and 612-493-6435. Our mailing address is 7550 Meridian Circle, Maple Grove, MN 55369-4927.

**Table 1-1: Optional Accessories for the 9800 receiver**

Item	Silent Knight Model Number (if applicable)	Description/Comments
Line card	9810	The line card monitors the phone line, detects ring and processes the message from the communicating panel.
Backup battery	6712 (See Section 3.10 for installation.)	A 12VDC 7ah battery which will provide a minimum 4 hours of backup power during an AC power loss. (See Section 2.3.2 for UL backup power requirements.)
Printer cable	Not available from Silent Knight	A standard 25-pin cable used to connect the 9800 receiver to an external parallel printer.
Rack-mounting cabinet	Not available from Silent Knight	Used to rack mount the 9800 receiver as required by UL. (See Section 2.3.1 for specifications and vendor information.)
Blank filler panels	Not available from Silent Knight	Used to fill up any unused cabinet spaces as required by UL.
Parallel printer	SK320	Silent Knight Model 9800 receiver requires the SK320 parallel printer to generate a hardcopy of report history.

## 1.3 Formats Compatible with the 9800

---

The 9800 receiver is compatible with all Silent Knight UL listed communicators.

Table 1-2 shows the formats that the 9800 receiver can decode and the handshake frequency groups which accommodate that format (see Section 5.4 for line card programming). Each line card can decode every format listed below. Setting the handshake order only prioritizes the type of communication done by each line card. Section 6 of this manual describes the formats in greater detail.

**Table 1-2: Formats compatible with the 9800**

Format Name	Handshake
BFSK	1400 or 2300 Hz
SK FSK, FSK 0, FSK 80	1400 or 2300 Hz
SK FSK 1, FSK 1, FSK 81	1400 or 2300 Hz
FSK II, FSK 86	1400 Hz
SK 4+2	1400 Hz
SK 3+1/3+1 Extended	1400 or 2300 Hz
Sescoa 3+1/Franklin 3+1	2300 Hz
Radionics 3+1 Checksum	1400 or 2300 Hz
4+1 Extended	1400 or 2300 Hz
FBI 4+3+1	1400 or 2300 Hz
SX-III, SX-IVA	2225 Hz
SX-IVB	2225 Hz
ITI SX-V	2225 Hz
ITI Commander	2225 Hz
ITI RF Commander, Harbor Gard	2225 Hz
ITI Commander 2000, LifeGard	2225 Hz
ITI CareTaker+, SecurityPro 4000	2225 Hz
ITI UltraGard	2225 Hz
SIA DCS	2225 Hz
SIA 2000 (pending approval)	2225 Hz
Ademco Contact ID	1400 and 2300 Hz
Ademco Super Fast	1400 and 2300 Hz
Acron Touch Tone	1400 and 2300 Hz
Ademco Express	1400 and 2300 Hz
DTMF 4+2	1400 and 2300 Hz

## 1.4 9800 Supported SIA Digital I-III Levels

Table 1-3 compares the 9800 receiver to SIA Digital Compatibility Levels I, II, and III and indicates which of them we comply with.

**Table 1-3: 9800 and SIA Levels I-III comparison**

		9800	Function/Capability	Transmitter	Receiver
<b>Level I</b>	<b>Level II</b>	✓	Support Tonal Acknowledgments	required	required
		✓	Support N blocks with Zone Numbers Only	required	required
		✓	Support single Account Block per Call	required	required
		✓	Support O Blocks	(optional)	required
		✓	Support X Blocks	(optional)	required
		✓	Support 300 Baud (Fast)	(optional)	required
<b>Level III</b>			Support Configuration Block	required	required
			Support Data Acknowledgments	required	required
	✓		Support Modifier codes <i>id</i> , <i>da</i> and <i>ti</i> .	(optional)	required
	✓		Support Multiple Account Blocks per Call	(optional)	required
	✓		Support E Blocks	(optional)	required
	✓		Support Data Codes with Units Numbers	(optional)	required
			Support RECEIVER call out and Access Passcode	required	required
			Support Reverse Channel C Blocks	required	required
			Support Reverse Channel P Blocks	required	(optional)
			Support Reverse Channel A Blocks	(optional)	required
			Support Dynamic block and Group Sizes	(optional)	required
	✓		Support Listen-in	(optional)	required
	✓		Support A Blocks to RECEIVER	(optional)	required
			Support V-Channel communication	(optional)	(optional)

## 1.5 How to Use this Manual

---

This manual contains information on how to install, operate and program the 9800 receiver. Silent Knight strongly suggests that the manual be reviewed in its entirety to become familiar with procedures and parameters of the product. Once you are familiar with the product, the manual can be used as a reference document.

The manual uses the following conventions:

- A small graphic of each touchpad button is used to represent which touchpad key is to be pressed for a given operation. For example, an up-arrow would be shown as: 
- LCD display      This typeface represents messages that appear on the LCD.
- **2225Hz**      This typeface represents an editable field that appears on the LCD.
- Pages of the manual are numbered by section. For example, a page numbered as “5-1” is Page 1 of Section 5.
- When this manual refers to **default settings**, it means programmable options set at the factory. Any programming after the receiver is powered up will change these setting.

## 1.6 Terminology

---

This section lists terminology that is specific to this product and their meaning.

Term	Meaning
Communication Group	Silent Knight has separated the different types of communication by handshake type. These handshake types can be assigned in a numbered order. (See Section 6 for more details.)
Listen-in	Listen-in is the ability to listen in to what is happening real-time from the central station to a remote location. This can help the central station operator determine if he or she should dispatch for a particular alarm situation.
PZT	PZT is an abbreviation for a piezo alert sounder.
PIN	An abbreviation for Personal Identification Number. PINs are used to log in and out of the receiver.
SBUS	Serial Bus interface to connect a 9800 receiver to 9810 Line cards and the LCD display.
MCPU	Master Central Processing Unit.
Main Menu	The main menu will be displayed as either <Installer Menu> or <Operator Menu>. However, this manual will refer to them as the main menu.
ACK	Stands for acknowledgment.
NACK	Stands for no acknowledgment.

## 1.7 What's in the Box

---

This section contains a list of the parts that are shipped with the 9800 receiver and a brief description of their intended use.

Item	Quantity	P/N	Description
Battery/Alert Relay Wiring Harness	1	130393	Wiring harness used to connect the 9800 receiver to a backup battery. It also provides a normally open or normally closed output for an alert sounder.
9800 Installation/Operation Manual	1	151018	A manual covering installation and operation information related to the 9800 receiver.
Central Station Receiver	1	9800	The central station receiver assembly.
Line Card	1	9810	Line card for land lines.
Strain Relief Tie Wrap	1	120101	Tie wrap used as a strain relief on the phone cord. See Figure 3-3 for location of strain relief tabs.
Receiver Mounting Screws	4	119593	#10-32 x 3/8 flat head screws used to mount the receiver to a UL listed rack. (See Section 3.4 for rack mounting instructions.)
Telephone Cord	1	130071	A 7 foot long telephone cable with RJ-11 connectors.
Power Cable	1	119229	AC power cable used to connect the 9800 receiver to an AC wall plug.

## 1.8 How to Contact Silent Knight

---

If you have a question or encounter a problem not covered in this manual, contact Silent Knight Technical Support at 800-328-0103 (or 612-493-6455). To order parts, contact Silent Knight Sales at 800-446-6444 (or 612-493-6435).



---

## Section 2

# Agency Requirements

---

---

### 2.1 Telephone Requirements

---

If requested by the telephone company, the following information must be provided before connecting this device to the phone lines:

- |    |  |                   |
|----|--|-------------------|
| A. | Manufacturer:  | Silent Knight     |
| B. | Model Number:  | 9800              |
| C. | FCC Registration Number:                                 | AC6USA-31519-AL-E |
| D. | Type of jack (to be installed by the telephone company): | RJ31X             |
|    | Ringer equivalence:                                      | 0.1B              |

This device may not be connected directly to coin telephones or party line services.

This device cannot be adjusted or repaired in the field. In case of trouble with the device, notify the installing company or Silent Knight for an RMA and then return it to:

Silent Knight Security Systems

7550 Meridian Circle

Maple Grove, MN 55369-4927

800-328-0103 or 612-493-6455

The telephone company may make changes in its facilities, equipment, or procedures that could affect the operation of the equipment. If this happens, the telephone company will provide advance notice to allow you to make the necessary modifications to maintain uninterrupted service.

### 2.2 FCC Warning

---

This device complies with FCC Rules Part 68.

This device has been verified to comply with FCC Rules Part 15. Operation is subject to the two following conditions: (1) This device may not cause radio interference, and (2) This device must accept any interference received including interference that may cause undesired operation.

## 2.3 UL Requirements

---

Follow the procedures outlined in the sections below for listing as an NFPA 72 Central Station Service installation. The 9800 is also suitable for household and commercial burglary service. Note that installation regulations are subject to the jurisdiction of a local authority.

### 2.3.1 Hardware Requirements

See Figure 3-4 and Figure 3-5 (Section 3) for diagrams of a suggested installation.

1. A second 9800 must be installed as a backup in case the primary 9800 fails. The backup system must be able to take over within 30 seconds. (Note: This requirement does not apply to burglary-only installations.)
2. The 9800 must be housed in a UL listed for fire protective signaling use, metal rack-mounting cabinet. A recommended enclosure is a listed control unit accessories system cabinet, manufactured by Atlas/Soundelier, (The series, WA200, intended for 19-inch rack mount panels, can be used.) A taller cabinet could be used to house additional units.
3. Any unused front panel rack space must be filled with blank panels so that all wiring remains enclosed.
4. The external conduit must exit through the knockouts in the cabinet or go directly through the floor.

### 2.3.2 Operational Requirements

1. The transmitters reporting to the 9800 must be UL Listed DACTs (digital alarm communicator transmitters).
2. The central station must provide a minimum of 24 hours of backup power within 30 seconds of a AC power loss. The backup must either be in the form of a UL listed UPS or electrical generator.
3. If the 9800 is not automated, the central station operator must check for the 24 hour test signals from the communicators. (Note: This requirement does not apply to burglary-only installations.)
4. The connection between the 9800 and the UL listed computer should be according to the pin configuration for Com port 1 as shown in Section 3.11, Figure 3-15 and Figure 3-16, of this manual.
5. If a computer is used, the computer and its accessories must be installed in the same room as the receiver.
6. If the listen-in feature is used the receiver must meet the loading requirements specified in NFPA 72 paragraph A-4-5.3.2.2.2.3. Additional line cards can be installed to meet this requirement, however, the additional line cards can not be programmed for listen-in. Any line card used for Listen-In must not be counted in the hunt group calculations.

### **2.3.3 Programming Requirements**

In a UL listed installation, the Model 9800 receiver must be programmed according to the following procedure:

- Do NOT use the alarm output relay in UL installations.
- Each log-on code must have at least four digits.



# Section 3

## Installation

This section contains information necessary to install a 9800 Central Station Receiver.

**IMPORTANT:**  
**Do not connect power to the system until you have read these instructions carefully.**

### 3.1 Environmental specifications

- Temperature range is 32° to 120° F.
- Indoor use only.
- 85 percent non-condensing humidity.
- Non-corrosive environment.

### 3.2 Electrical Specifications

Line Voltage:		120VAC ± 10%	60Hz, 100VA
		240VAC ± 10%	50Hz, 100VA
Fuse:		2.5A Slow Blow	
Backup Battery Connection: <i>Note:</i> A 12 VDC battery does not provide standby time required by UL and NFPA standards. A UPS (listed for Protective Signaling Use) must be utilized when standby power is required. See 5.3.4 for details on backup battery configuration.	Input	10.2 to 14.0 VDC	3 Amp Max.
	Output	13.65 VDC	1 Amp charging current
Auxiliary Relay:		2.5 Amp @ 48VDC	Resistive Power Limited
		2.5 Amp @ 48VAC	Resistive Power Limited

### 3.3 Overview

The 9800 is assembled at the factory. One line card is shipped with the 9800 receiver. Follow the procedures described in Section 3.5 to install additional line cards.

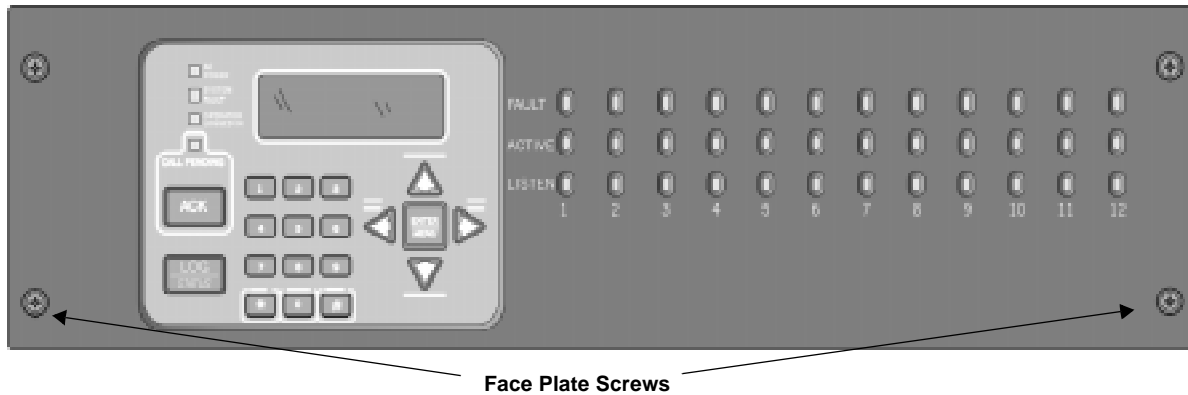

Figure 3-1 Model 9800 Front View

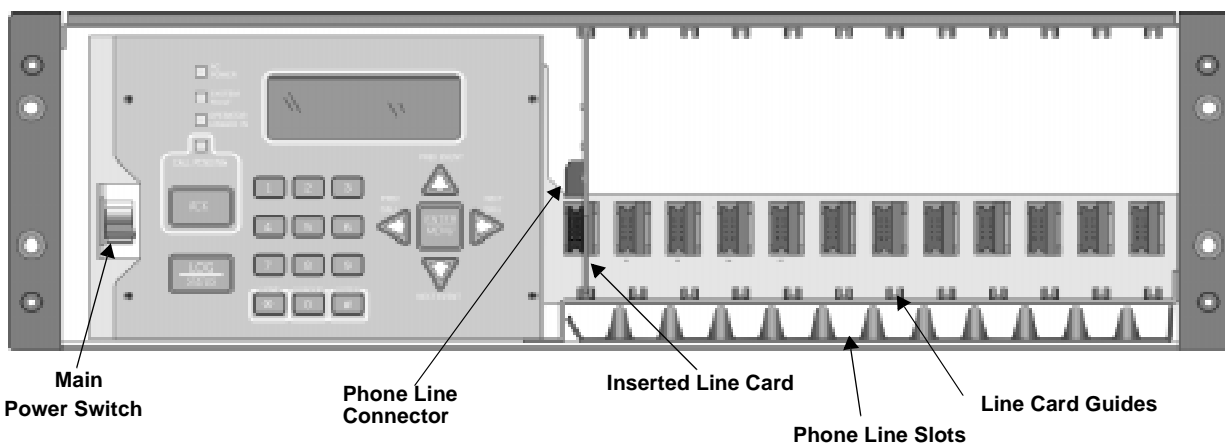

Figure 3-2 Model 9800 Front View Without Front Plate Attached

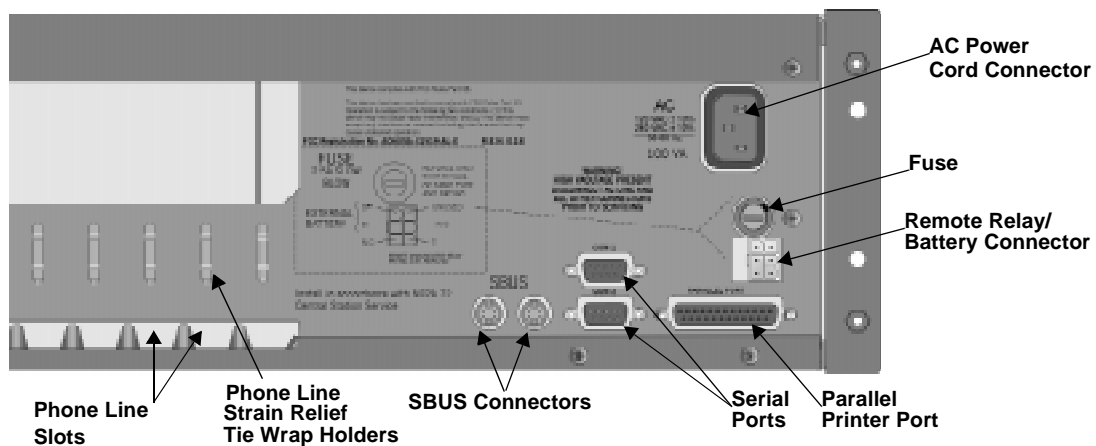
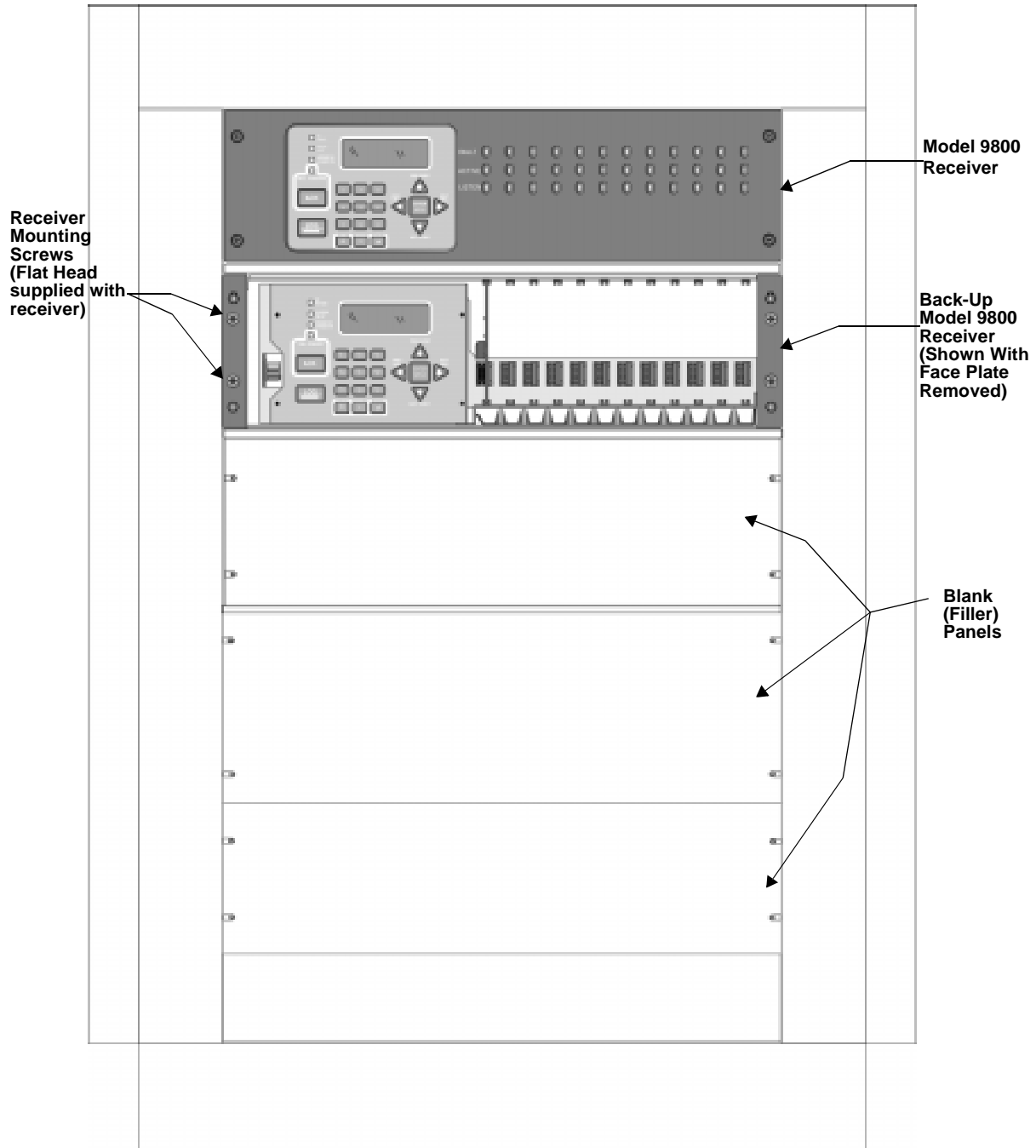

Figure 3-3 Model 9800 Rear View

### 3.4 Rack Mounting

This diagram shows how to mount the model 9800 in a UL listed rack enclosure.



**Figure 3-4 Rack Mount Enclosure, Front View**

*Note: All wiring that exits cabinet must be in electrical conduit.*

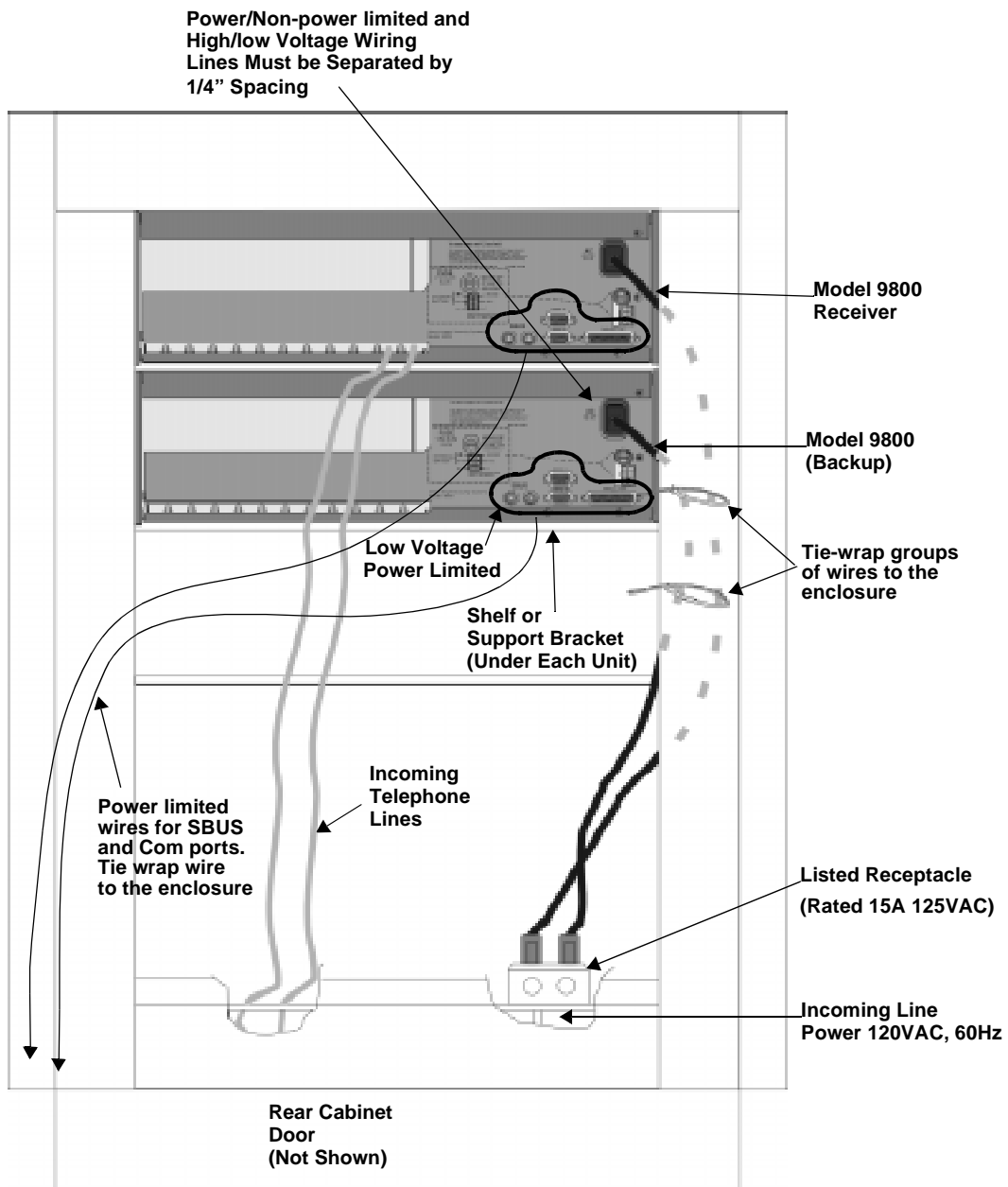

Figure 3-5 Rack Mount Enclosure, Rear View

Note: All wiring that exits cabinet must be in electrical conduit.



## 3.5 Line Card Installation

### Caution:

To reduce the risk of electrical shock and damage to the receiver, follow these steps in the order they are listed here.

1. Open the 9800's front panel by unscrewing the four front plate retaining screws located on the front of the panel. (See Figure 3-1 for front plate retaining screw locations.)
2. Turn off the 9800's AC power switch (see Figure 3-2 for power switch location).
3. When the front panel is removed, you will see that there are 12 slots for line cards. The receiver recognizes each slot by number 1 through 12 (slot one is closest to the keypad and display). It is not necessary to put line cards in numbered order because the receiver continually polls each slot to see if existing line cards are functioning and if it is still in its slot. The receiver also looks to see if a new line card has been added. Figure 3-6 shows where each line card should be placed.

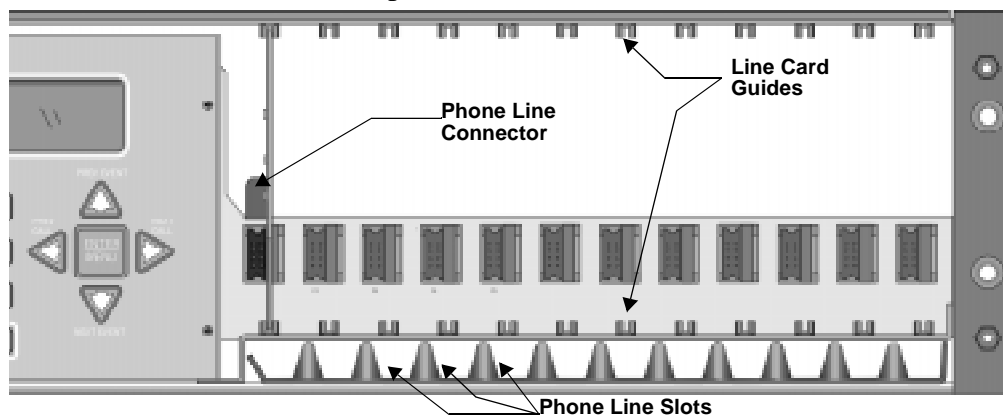

Figure 3-6 Line Card Locations

4. Position the line card as shown in Figure 3-7.

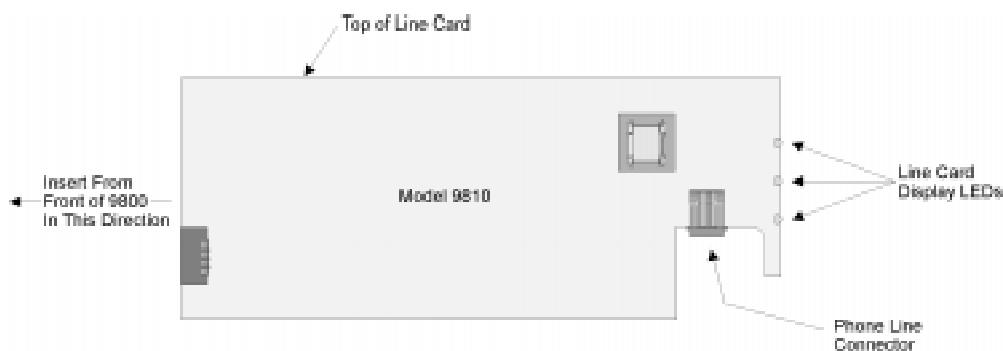

Figure 3-7 Line Card Position and Components

5. Carefully slide the card into its guides (both top and bottom) until it fits into its connector at the back of the receiver. Gently push the card as far into the connector as you can. The card is now in place.
6. Connect telephone line. (See Section 3.7 for telephone line installation.)

*Note: Use the tie wrap (P/N 120101 provided with each line card) on the tie wrap holder to add strain relief to the telephone lines. See Figure 3-3.*

7. Power up the 9800.
8. Close the 9800's front panel and tighten the front plate retaining screws to hold the front plate in place. If you are simply replacing a line card with another card of the same type and are using the same format settings, your installation is now complete. If not continue to the next step.
9. Enter programming mode to select the appropriate handshake configuration. (Go to Section 5.4 for programming procedure.)

## 3.6 Removing Line Cards

---

If you need to remove a card:

1. Open the 9800's front panel by unscrewing the four front plate retaining screws located on the front of the panel. (See Figure 3-1 for front plate retaining screw locations.)
2. Turn off the 9800's AC power switch (see Figure 3-2 for power switch location).
3. With the front panel removed, you will see that there are 12 slots for line cards.
4. Locate the Line Card that you wish to remove.
5. Unplug the telephone line. (See Figure 3-6 and Figure 3-7.)
6. From the front side of the receiver pull the line card straight back. This will pull the card free from the connector.
7. When the card is free, slide it carefully out of the receiver.

*Note: If replacing a line card with a new one see Section 3.5 to install the new line card.*

8. Power up the 9800.
9. Close the 9800's front panel and tighten the front plate retaining screws to hold the front plate in place.
10. Enter programming mode to clear the linecard from the system.. (See Section 5.4 for programming procedure.)

## 3.7 Telephone Line Connection

---

See Figure 3-6 for the location of the phone line inputs. Connections to the 9800 phone jacks are made with a standard 7-foot phone cord (provided with each line card).

Use the following procedure to connect phone lines to the 9810 line cards:

1. Remove the front panel of the 9800 receiver by loosening the front plate retaining screws. (See Figure 3-1 for front plate retaining screws locations.)
2. From the back side of the receiver insert the telephone line through the corresponding slot for the desired line card. (See Figure 3-6 and Figure 3-7 for phone line slot locations.)
3. Gently push it all the way through to the front side of the receiver.
4. Plug the RJ-11 phone connector into the connector on the 9810 line card. (See Figure 3-6 and Figure 3-7.)

*Note: Use the tie wrap (P/N 120101 provided with each line card) on the tie wrap holder to add strain relief to the telephone lines. See Figure 3-3.*

5. Replace the front panel of the 9800 receiver by tightening the front plate retaining screws. (See Figure 3-1 for front plate retaining screws locations.)

## 3.8 Parallel Printer Connection

---

The 9800 Receiver connects to model SK320 printer for UL applications. To connect the SK320 to the 9800 receiver follow these steps:

1. Connect the standard parallel printer cable to the parallel printer port on the back of the 9800 receiver. (See Figure 3-8.)

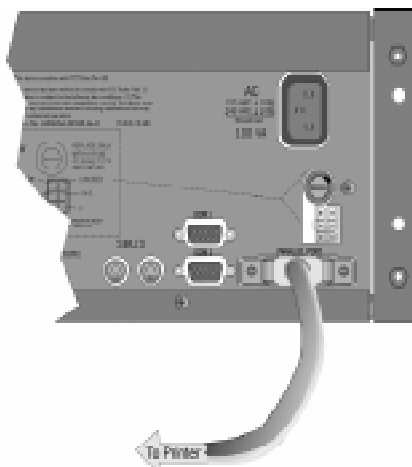

**Figure 3-8 Parallel Printer Cable Connection to 9800**

2. Connect the other end to the SK320 parallel printer port.

*Note: Make sure that printer power is turned off.*

3. Turn the printer power “on”.

### 3.8.1 Printer Cable Pin-Outs

25 pin printer cables are a standard items at most electronic stores, however, if you create your own cable, use the pin description in Table 3-1.

**Table 3-1: External Printer Cable Pin Description**

9800 Pin #	Signal	Direction	Description
1	Data Strobe (Low)	Out	A low strobe pulse to read data in the pulse width is greater than 0.5 microseconds.
2	Data Bit 1	Out	These signals represent information of the first to eighth bits of parallel data. Each signal is at high level when the data is logic 1 and low when it is logic 0.
3	Data Bit 2	Out	
4	Data Bit 3	Out	
5	Data Bit 4	Out	
6	Data Bit 5	Out	
7	Data Bit 6	Out	
8	Data Bit 7	Out	
9	Data Bit 8	Out	
10	/AckNlg	In	A low pulse from the printer signals the control that the printer is ready for additional data.
11	Busy	In	A high level indicates that the printer is busy.
12	Paper Empty	In	A high level indicates that the printer is out of paper.
13	Select	In	A low level indicates the printer is offline or in an error condition.
14	Not used	-	-
15	Not used	-	-
16	Logic ground	-	Logic ground for printer
17	Not used	-	-
18 to 25	Logic Ground	-	Ground return for data lines.

Figure 3-9 shows the wiring sequence of this connector.

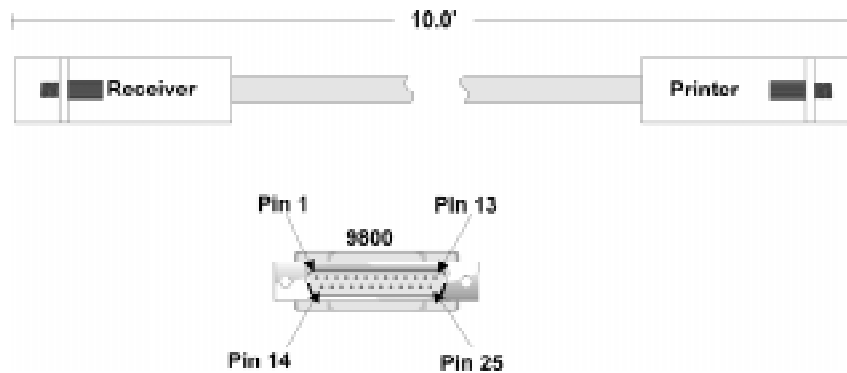

Figure 3-9 Wiring Sequence For Parallel Printer Port Interface

### 3.8.2 Com Ports 1 & 2

Com ports one and two are serial communication ports that (through a null modem cable) can be used to communicate to other serial communication devices. Com port one is the only serial communications port that can be used with the automation computer (see Section 3.11). A standard null modem cable can be used to connect com port 1 or 2 to another serial device such as a printer or a PC. Figure 3-15 and Figure 3-16 shown the pin-outs for a null modem cable. See Section 5.3.3 to configure the Com Port 1 and Com Port 2.

### 3.8.3 Remote Alert Output

1. Plug the Battery/Relay wiring harness onto the connector on the back of the 9800 receiver. (See Figure 3-10.)

*Note: The remote alert output is a form C relay with a normally open or a normally closed wire.*

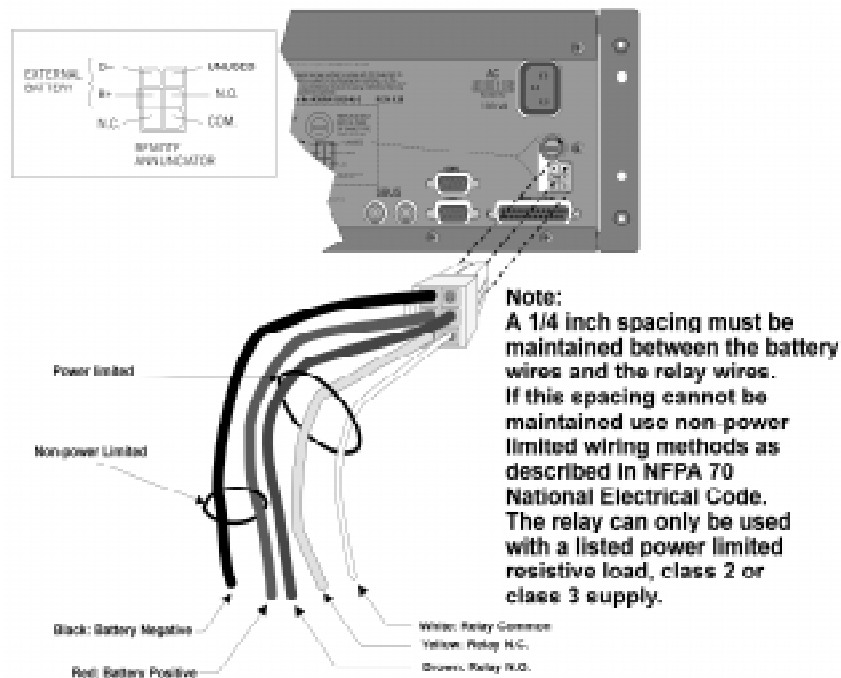

Figure 3-10 9800 Remote Alert Output/Backup Battery Connection

2. Connect the white wire to common.
  3. Use the Yellow wire for a normally closed circuit
- Or
- Use the Brown wire for a normally open circuit.

## 3.9 AC Power Cord Connection

---

1. Before the AC power cord is connected, make sure that the power switch is in the OFF (down) position.
2. Connect the appropriate end of the power cord into its receptacle on the back of the 9800.
3. Plug the three-pronged end of the power cord into a 120 VAC 60 Hz outlet (three-prong type only). The outlet should be unswitched, so that power remains on 24 hours a day. The outlet must also be earth grounded. Follow the directions in Section 3.9.2 if you need to measure for proper earth grounding.

### 3.9.1 Switching to a 230 VAC Power Supply

1. Remove the front plate by unscrewing the front plate retaining screws. (See Figure 3-1 for locations of front plate retaining screws.)
2. Turn the main power switch to the “off” position. (See Figure 3-12.)
3. Disconnect AC power cable.
4. Disconnect the backup battery. (See Figure 3-14.)
5. On the back of the receiver remove the four screws that hold the mother board/power supply assembly to the chassis. (See Figure 3-11 for screw locations.)

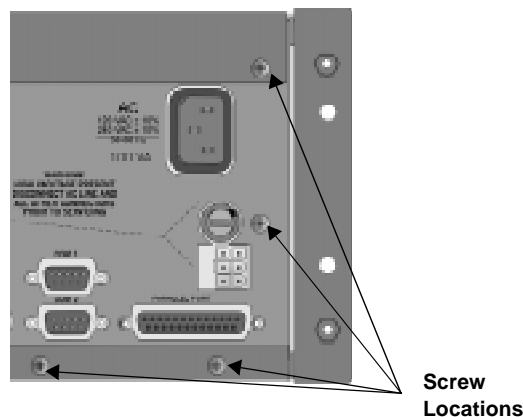

**Figure 3-11 Mother Board/Power Supply Assembly Retaining Screw Locations**

6. From the front of the receiver pull the mother board/power supply assembly out.

- Switch the power supply select switch to the up position. The switch will show 230VAC. (See Figure 3-12.)

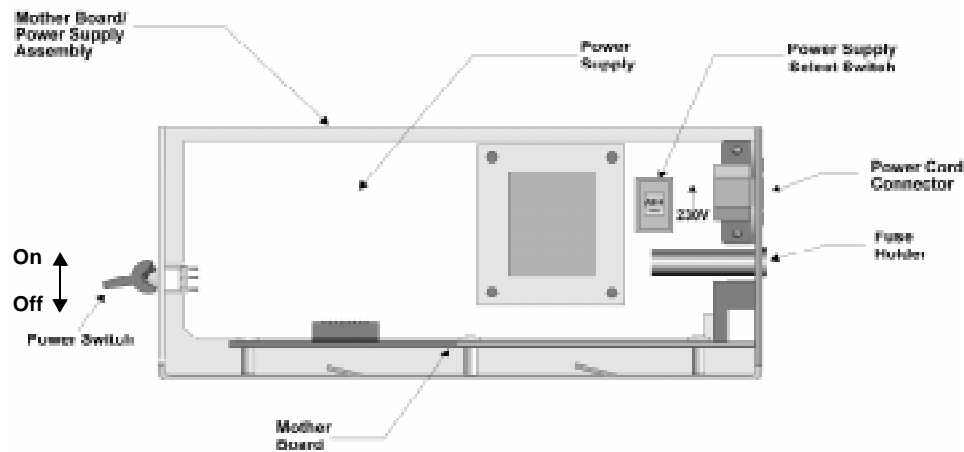

**Figure 3-12 Side View of Mother Board/Power Supply Assembly**

- Slide the mother board/power supply assembly back into the receiver chassis.
- On the back of the receiver replace the four screws that hold the mother board/power supply assembly in place. (See Figure 3-11.)
- Reconnect the AC power cable.

*Note: Make sure to plug the AC power cable into a grounded 240VAC outlet.*

- Reconnect the back-up battery. (See Figure 3-14.)
- Turn the main power switch to the “on” position. (See Figure 3-12.)
- Replace the front plate by screwing in the front plate retaining screws. (See Figure 3-1.)

### 3.9.2 How to Verify Earth Ground

To verify earth ground at the AC outlet the 9800 receiver is powered from, use the following steps:

1. Measure the AC voltage between the center ground post and each side of the outlet (see A & B in Figure 3-13). You should read approximately 120 VAC (or 240VAC for 240VAC circuits) at measurement point B and nominal VAC at measurement point A.

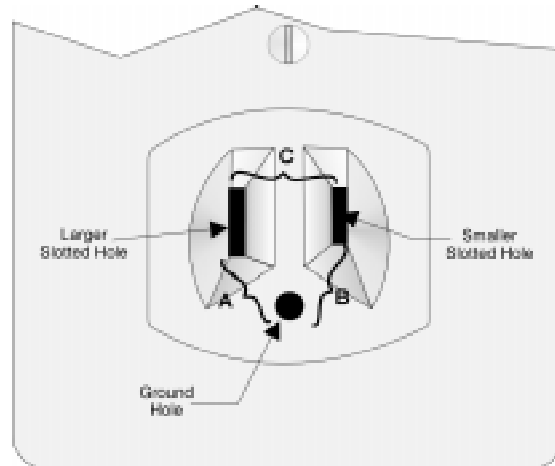

**Figure 3-13 Outlet Voltage Measurement Points**

2. Measure the voltage between the two slotted holes. It should be equal to the voltage reading at measurement point B. (See Figure 3-13.)

If these voltages are not equal, the outlet does not have a proper earth ground.

3. Ground the outlet by running a wire (18 gauge or higher) to a good earth ground.

The wire should be of equal or greater diameter to the wires used to feed the outlet. It may be necessary to have a licensed electrician ground the outlet.



## 3.10 Battery Connection

---

To install the 6712 backup battery follow these steps:

*Note: The 6712 (12VDC 7ah battery) will provide a minimum of 4 hours of battery backup power. (See 2.3.2 for UL requirements.)*

1. Plug the Battery/Relay wiring harness onto the connector on the back of the 9800 receiver. (See Figure 3-14.)

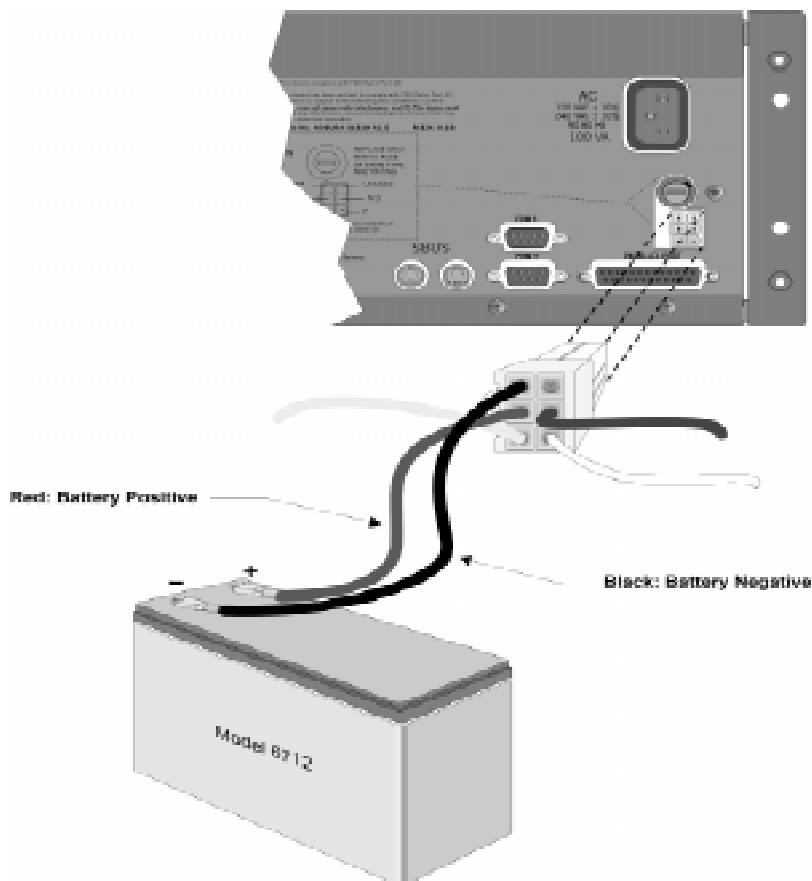

**Figure 3-14 Battery Connections**

2. Connect the RED terminal to the positive (+) side of the battery.
3. Connect the BLACK terminal to the negative (-) side of the battery.

*Note: Incorrect polarity can damage the battery and the 9800.*

## 3.11 Automation Computer Connection

An automation computer can be connected to Com Port 1 on the 9800 receiver. Com Port 1 is a 9-pin DTE port. Refer to Section 8 for details on automation communication protocols. The diagrams below describe some of the cable options.

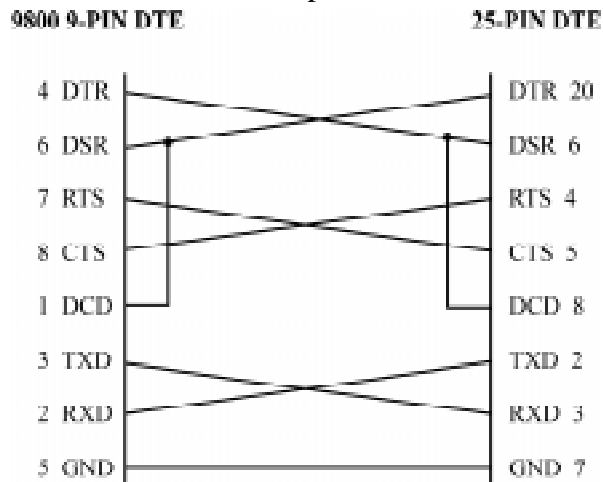

Figure 3-15 25-Pin Null Modem Cable Connection

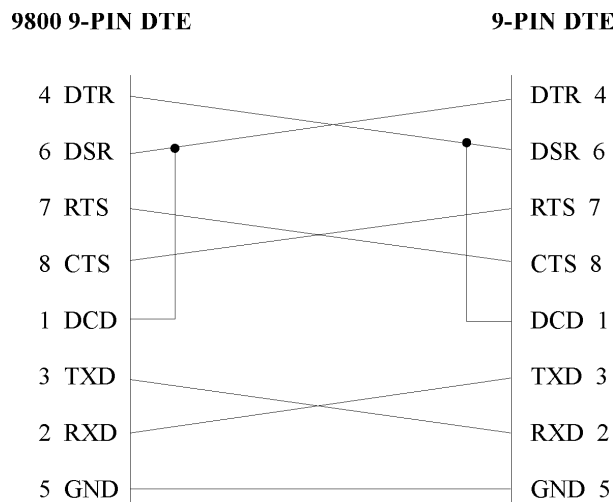

Figure 3-16 9-Pin Null Modem Cable Connection

### 3.11.1 Computer Port Baud Rate Selection

The computer port baud rate is selectable from 110 to 19200 (See Section 5 *Programming*).

---

## Section 4

# Operation

---

This section covers information on how to operate the 9800 Receiver.

### 4.1 Touchpad Function Buttons

---

The front panel of the 9800 is made up of; a touchpad, containing numbers, arrows and buttons; a LCD display; and an array of LED indicators. (See Figure 4-1.)

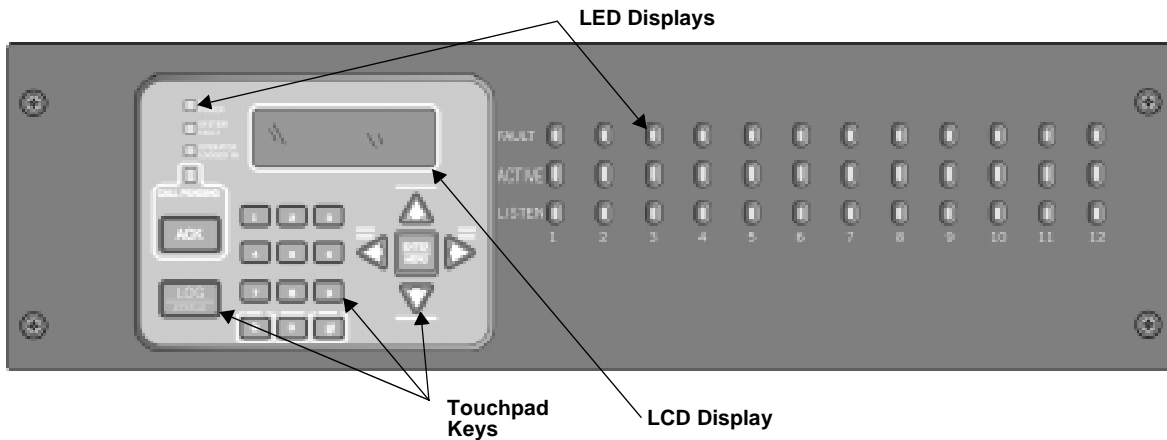

**Figure 4-1 Model 9800 Front Panel**











The touchpad on the 9800 Receiver is used in all operating modes (normal and programming mode).



**Figure 4-2 Touchpad Layout**

Table 4-1 displays each individual touchpad key and describes its function in each operating mode.

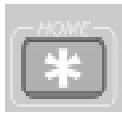
**Table 4-1: Touchpad Buttons Description**

Key	Name	Operating Modes	
		Normal	Programming
	Up Arrow	Display previous event.	Go back to previous choice or character.
	Down Arrow	Display next event.	Move to next choice or character.
	Left Arrow	Display previous call.	Exit the current menu. Move to previous programming field.
	Right Arrow	Display next call.	Select menu item indicated by equal sign (see Figure 4-6). Move to next programming field.
	Enter/Menu Button	Bring up Main Menu.	Select menu item indicated by equal sign (see Figure 4-6). Enter chosen parameter.
	Acknowledge Button	Manually Acknowledge a call or event. (Used only if receiver is in manual mode.)	Used in log mode to acknowledge and silence system troubles.
	Log Button	Pressed to log on or off the system. Pressed to view system status messages.	N/A
	Digit Keys	Used to enter numeric inputs.	Numeric input, option selection.
	Star or Home Key	Will return display to the oldest unacknowledged event.	Enters a * Character when programming in an "Edit" field. See Table 5-1 for <i>Types of Programming Fields</i> , descriptions.
	0 or Hangup key	In manual mode the 0/hangup key is used to hangup line card when the listen feature was activated, or to end a runaway call from a panel.	Used to enter numeric inputs.
	Pound Key or Listen Key	In manual mode this key is used to initiate the listen in feature.	Enters a # Character when programming in an "Edit" field. See Table 5-1 for <i>Types of Programming Fields</i> , descriptions.

## 4.2 Displays

This section describes the two types of displays that the 9800 receiver uses.

### 4.2.1 LED Displays

**Table 4-2: LED Description**

LED		Meaning		
		On	Off	Flashing
Touchpad LEDs	AC Power	AC power is on.	No AC or DC power to the Receiver	No AC power and the system is operating on the backup battery.
	System Fault	A fault condition exists that has been acknowledged but not cleared.	The system is operating normally.	A fault condition exists that has not been acknowledged.
	Operator Logged In	An operator is logged on.	No operator is logged on.	
	Call Pending	The acknowledge key was pressed at least once, but not all the events in a call were acknowledged.	No calls pending or all calls have been acknowledged.	Calls pending.
Line Card LEDs	Fault	N/A	The line card is operating normally.	Trouble or fault condition exists.
	Active	The line card is in active communication.	No Activity.	Indicates the line is ringing.
	Listen	Comes on when operator acknowledges the listen-in call.	No listen-in occurring.	N/A

### 4.2.2 LCD Status Display

The status display is a 4-line 20 character (each line) back-lit LCD that shows the various alarm and function messages. It functions in all modes of operation (normal and programming mode). As the 9800 acknowledges calls and messages, it updates the calls on the LCD and silences the alert tone.



**Figure 4-3 LCD Display**

### 4.2.2.1 Adjusting LCD Contrast

The LCD is factory set at the highest contrast level and for most installations will not need to be adjusted. Use these steps to change the LCD contrast if the brightness of the room or the location in which the receiver is located should require a contrast change:

1. Press and hold both the up arrow and the left arrow keys at the same time. (See Figure 4-4.)



**Figure 4-4 Contrast Adjustment**

2. Release the up and left arrow keys when you reach the desired contrast level.

### 4.2.2.2 LCD Abbreviations

Many of the words used on the LCD are abbreviated to accommodate 20 characters per line. Table 4-3 compares the event that is reported to how it is output to the LCD and printer.

**Table 4-3: LCD and Printer Abbreviations**

Event	LCD	Printer
Alarm	Alrm	Alarm
Trouble	Trbl	Trouble
Restore	Rstr	Restore
Supervisory	Sprv	Superv
Opening	Open	Opening
Closing	Clos	Close
Remote	Rmot	Remote
Disable	Dsbl	Disable
Bypass	Byps	Bypass
Unbypass	Ubyp	Unbypass
Test	Test	Test
Listen-in	Lstn	Listen
System	Sytm	System
Access	Accs	Access
Report	Rprt	Report
Cancel	Cncl	Cancel
Zone Number	Z#	Zone
Door Number	D#	Door
User Number	Us#	User
Area Number	A#	Area

## 4.3 Initial System Power Up

Apply power to the 9800 by plugging in the AC power cable and then turning the main power switch “on”. (See Figure 3-2 and Figure 3-3.) When the 9800 powers up, the display will go through the routine shown in Figure 4-5.

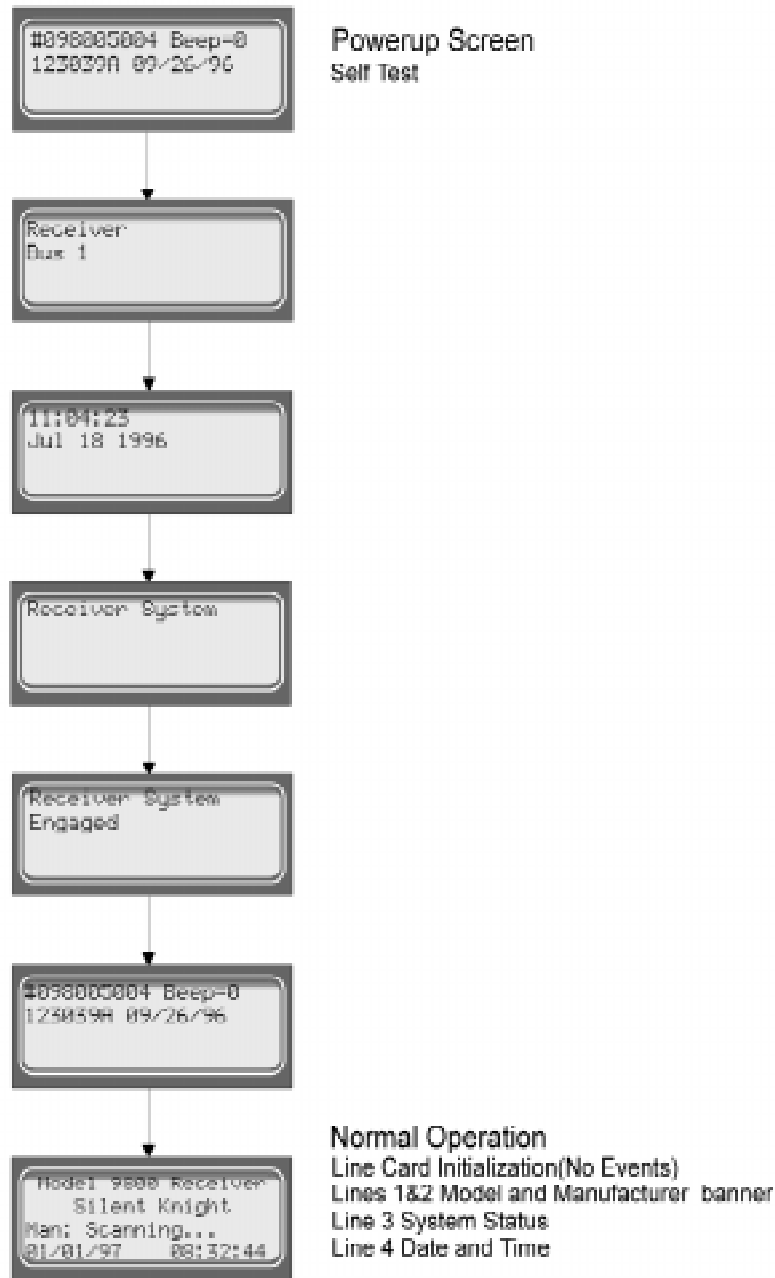

**Figure 4-5 Power-up Routine**

The system defaults in the manual operation. To select automatic operation see Section 5.3.1.1.

*Note: Any time the main power switch is turned off the time and date will have to be reprogrammed on power-up.*



## 4.4 Log On / Log Off

---

Persons operating the 9800 must log on and off the system. This is a way of keeping track of whom is operating the system at any given time. You can program a total of 40 codes. Each code will be assigned to one of two user profiles (Installer profile or Operator profile). (See Section 4.4.3 for default user codes.)

### 4.4.1 Installer Profile

The Installer profile will have access to all options on the main menu (see Table 4-4 for “Main Menu” options).

### 4.4.2 Operator Profile

The Operator profile has access to fewer main menu options than the Installer profile (see Table 4-4). These options allow the operator to perform basic operation of the 9800. Both profiles can acknowledge all calls and events.

**Table 4-4: Main Menu Option Items by Profile**

Installer Profile	Operator Profile	Menu Options
✓	✓	Call History
✓	✓	System History
✓	✓	System Info
✓	✓	Set Time & Date
✓	✓	System Restart
✓		Printer Menu
✓		Program Menu
✓		Diagnostics

*Note: See Section 4.6 for detailed information on the main menu options.*

**You must have at least one Installer Profile Code programmed in the system at all times.**

### 4.4.3 Default User Codes

At initial power up, the system provides two default user codes. User code 1 defaults with an Installer profile and user code 2 defaults with an Operator profile. Table 4-5 shows the default codes and their profiles.

**Table 4-5: Default User Codes**

User Number	Default Code (PIN)	Default Profile
*1	9800	Installer
2	1111	Operator

*\* Note: User code 1 can be changed but not deleted. User code 1's profile will always remain as "installer".*

### 4.4.4 How to log on the system.

Follows these steps to properly log on to the system:

1. Press the  button.

The LCD will display Enter Log In Code:  
[ ]

2. Enter your PIN code. (See Table 4-5 for default codes.)

*Note: This screen will time out after 15 seconds.*

3. Press the  button.

If the correct PIN is entered the LCD will display Installer # XX  
User Name.

The "Operator Logged In" LED will also turn on.

If an invalid code is entered the LCD will display Access code not verified.

*Note: If the previous user has not logged off, a new user can still log on by entering a PIN code. This will automatically log off the previous user and log in the new user.*

## 4.4.5 How to log off the system.

Follows these steps to properly log off the system:

1. Press the  button.

The LCD will display

```
#nn User Name
Log Out
[ ]
```

*Note: This screen will time out after 15 seconds.*

2. Enter your PIN code. (See Table 4-5 for default codes.)

3. Press the  button.

If the correct PIN is entered the LCD will display User Name Logged out. The “Operator Logged In” LED will also turn off.

If an invalid code is entered the LCD will display Access code not verified.

## 4.5 Modes of Operation

---

This section describes the different modes of operation for the 9800 Receiver (normal mode and programming mode) and the options available in them.

### 4.5.1 Normal Mode

Normal mode consists of three options, one if the receiver is intended to be used with a automation system, one for manual operation, and one to just log the events without manual acknowledgments or automation communication.

#### 4.5.1.1 Manual Operation

Requires a manual acknowledgment of each call or event from an operator.

##### How to Manually Acknowledge Calls:

When a the call pending LED is flashing and the on-board annunciator is beeping:

1. Press the  button to acknowledge the call.
2. Repeat step 1 until all calls are acknowledged and the display shows No More Data.

#### 4.5.1.2 Automatic Operation

Event information is sent directly to the automation computer.

*Note: If the automation system fails, the receiver will automatically switch to manual mode in less than 30 seconds. The switching time is twice the value set in Ack Timeout (See Table 5-5). The receiver will return to automatic mode after communication to the automation computer is restored.*

#### 4.5.1.3 Log Only

Log only mode will log event data without manual acknowledgments or communications with the automation computer. All event information is intended for printer output.

*Note: On initial power-up the receiver will default in manual operation. The receiver can be set to automatic or log only operation in program mode (see Section 5.3.1).*

### 4.5.2 Program Mode

In program mode all general, line card, and user profile options can be changed. See Section 5 *Programming* for more detailed information on programming the receiver or refer to the Quick Chart (, Table A-1) for programming overview.

## 4.6 Main Menu

This section gives detailed information about the items available in the Installer/operator menu options, which this manual will refer to as the main menu. The menu items available to each logged on user is dependent on the profile assigned to that user (see Table 4-4 for menu items for each profile). The user profile is assigned to each user through programming (see Section 5.5 for programming user profiles).

### 4.6.1 How to display the Main Menu

Once a user has logged on to the system (see Section 4.4.4), follow these steps to view the main menu options:

1. Press the  button.

The LCD display will show the main menu options.

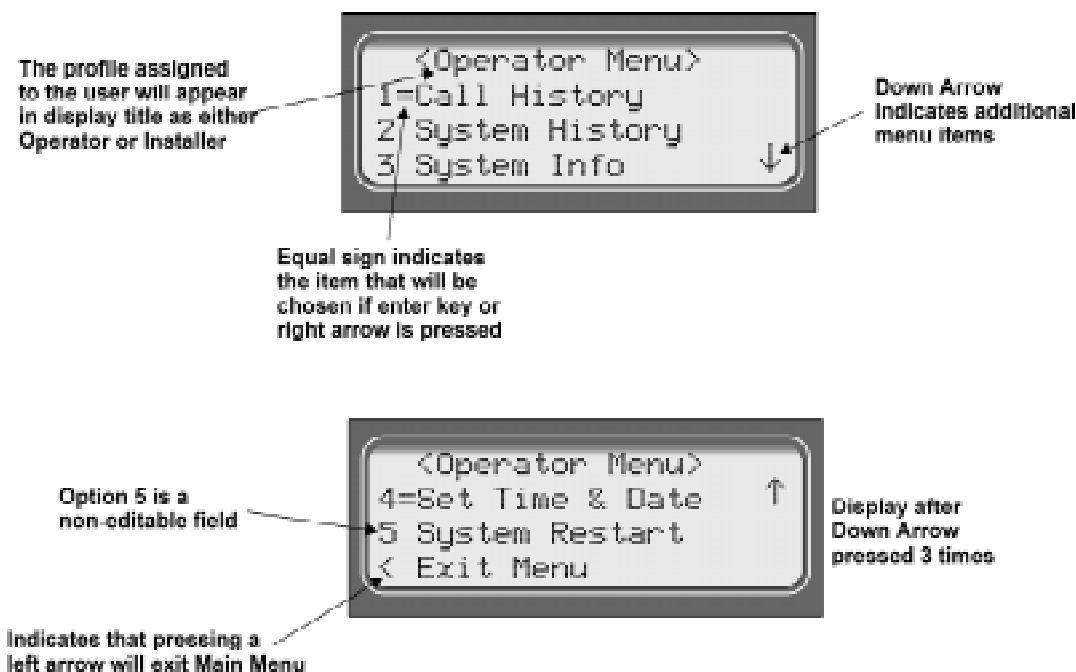

**Figure 4-6 Main Menu Display**

*Note: The main menu display will remain visible for 15 minutes of idle time after which it will revert back to the manual or automatic display window. See Figure 4-3.*

2. Choose the desired menu item. (See Figure 4-7.)

## 4.6.2 How to Maneuver Through Main Menu

Figure 4-7 indicates what keys on the touchpad are used to maneuver through the Main Menu.







Menu Controls	
To accept a menu item press	
Or press	
Or press the number key corresponding to the desired menu option	 Number can also be used to enter numeric information where needed
To Choose the next menu item press	
Go back to previous choice	
Exit current menu or menu item. Move back to previous entry.	

Figure 4-7 Main Menu Controls



### 4.6.3 Call History

Call history displays the calls that are in the history buffer.

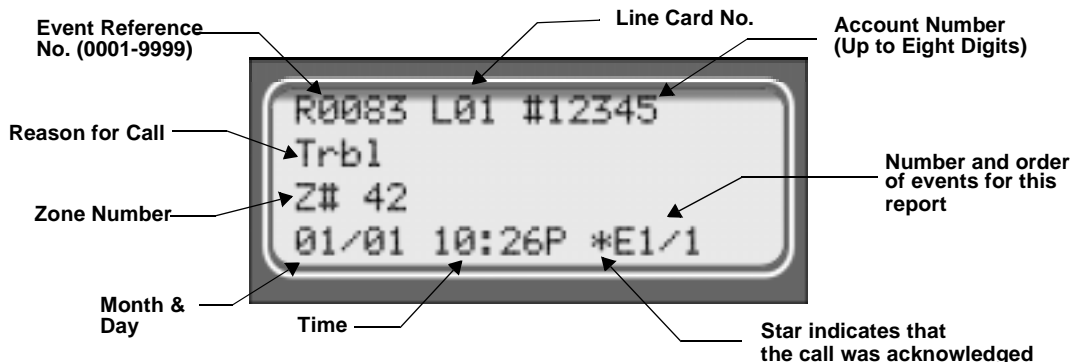

**Figure 4-8 View of a Call History Screen**

*Note: The Letter preceding the linecard number may appear as a "G" if the linecard the call came in on is programmed for a hunt group. See "Misc. Line Opt." in Section 5.4.2.5.*

To display a specific event enter the reference number then press the . Press the  to go to most recent call. See Table 4-3 for display abbreviations.

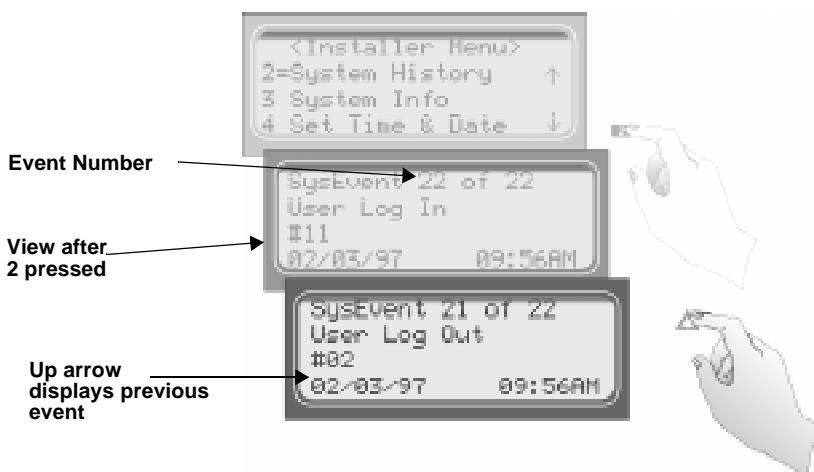

### 4.6.4 System History

System history displays any events that are stored in the history buffer. System events are any events related to the receiver operation such as line card faults, low backup battery, AC power loss, log in, log out, system program change, communication failure to a printer or automation system, etc.



**Figure 4-9 System History Display Sequence**

*Note: Up arrow moves back to the previous event that occurred.*

To display a specific event enter the event number (see Figure 4-9) then press the . Press the  to go to most recent call.

## 4.6.5 System Info

System Info is a non-editable screen that displays the model number, the software revision, software date code, receiver ID number. If a down arrow is pressed, the display will show the line card firmware information, which includes the model number, the software revision, the software date code, and letter revision.

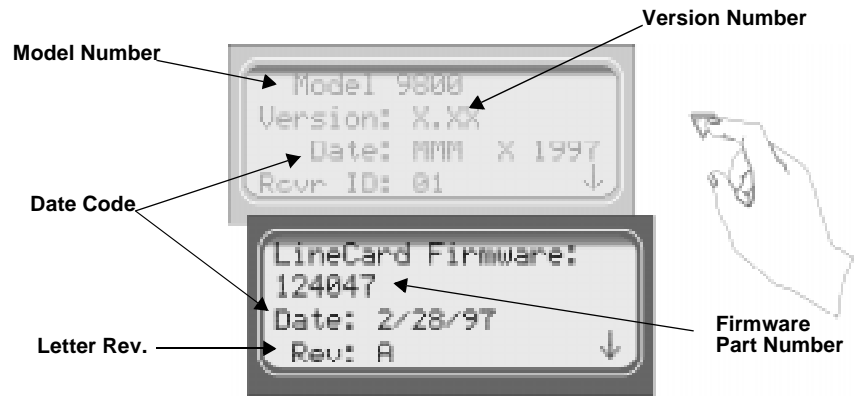

Figure 4-10 System Information Display



## 4.6.6 Set Time & Date

If Set Time & Date, is selected the operator can change the time and date currently displayed on the receiver. (See Figure 4-11 for setting time and date procedure.)

### Set Time and Date

1. Press the Menu button.
2. Press the 4 button to

3. Set the Hour (1 to 12). The field to be changed flashes.



4. Set the Minutes. The field to be changed flashes.



5. Set time to AM or PM. The field to be



6. Set the Month. The field to be changed flashes.



7. Set the Day. The field to be changed flashes.



8. Set the Year (0 to 99). The field to be



9. Set Greenwich mean time offset (+ or -). The field to be



10. Set the number of hour offset from Greenwich mean time.



11. Set the number of minutes (in 10 minute increments) offset from Greenwich mean time.



12. Press Enter button at the correct time to synchronize with.



Figure 4-11 Setting Time and Date Program Sequence

## 4.6.7 System Restart

System restart allows the operator or installer to restart the receiver. An installer has the option to set the receiver back to factory default settings, while an operator can only restart the receiver.

*Note: The time and date set in the receiver will be saved. However, all of the call history will be lost*

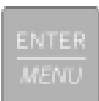

**Figure 4-12 System Restart Display**

Follow These Steps to restart the receiver:

*Note: All messages must be acknowledged before a system restart procedure can be performed. If all messages are not acknowledged, cycle the receiver's power to restart the system. If the power is cycled all unacknowledged messages will be lost.*

1. Log on to the receiver (see Section 4.4.4 for log on procedure).

2. Press the  button to view the main menu items.

3. Press  for System Restart.

The display reads

```

Do you wish to
shutdown & restart
system?No
    
```

4. Press the  or  button to toggle No to Yes.

5. Press . Users with an operator profile are done at this point.

The display reads

```

Do you wish to set
to factory default
settings?No
    
```

*Note: This display will only appear if the logged on User has an Installer Profile (see section 4.4.1).*

6. Press the  or  button to toggle between No and Yes.

*Note: If you choose Yes all linecard and user custom programming will be lost.*

## 4.6.8 Printer Menu

In the print menu you can print customized reports by the type of alarm (as defined by UL 864, Section 72.15F), edit the desired print output, configure output for your printer.



Figure 4-13 Print Menu Items

Table 4-6: Printer Menu Choices

Printer Menu	Choice 1	Choice 2	Comments	
Print Report	Call History	Priority 1 (Life safety signals-Fire, Duress)	Y Indicates that this item will print on this report.	
		Priority 2 (Property safety signals-Burg.)	N Indicates that this item will not print on this report.	
		Priority 3 (Supervisory signals)	The call History print will execute once you exit from "Choice 2". <b>Note:</b> Choice 2 settings are not retained in flash memory and have to be chosen for each call history printing.	
		Priority 4 (Trouble signals)		
		Priority 5 (All other signals)		
	System History		This option prints all the system events in the event history buffer.	
	System Config	Print All		Print all of the receiver and line card data.
		Program Data		Print just the systems programmed data.
Line Card #			Print line card configurations per line card.	
Test Page			Print a test page.	
Edit Evnt Format	Date	Y or N	Y Indicates that this item will print on a report. N Indicates that this item will not print on a report.	
	Format Type	Y or N		
	Ref Number	Y or N	Default setting is Y for all edit event format options. These settings are saved to flash memory.	
	Call Sep	Y or N		
	Device Num	Y or N		
Config Printer	Line Terminator	CR or CRLF	CR = Carriage return. CRLF = Carriage return and Line feed.	
	Offline Time	0 - 60 seconds	Offline time is how long the receiver will wait before giving a trouble indication after communication is lost with the printer. The default setting is 2 seconds. (30 second maximum for UL applications.)	
	Switch Delay Time	0 - 60 seconds	Switch delay time is the duration the receiver will wait before switching to the backup printer after communication is lost with the primary printer. The default setting is 20 seconds.	

### 4.6.8.1 Print Report

Through the print report option you can choose to print the call history, system history, system configuration information, or just print a test page.



Figure 4-14 Print Report Menu Items

#### How to Print Call History

Follow these steps to print the call history:

1. Log on to the receiver (see Section 4.4.4 for log on procedure).

2. Press the  button to view the main menu items.

3. Press  for the printer menu. (See Figure 4-13.)

4. Press  for print report menu. (See Figure 4-14.)

5. Press  for call history options.

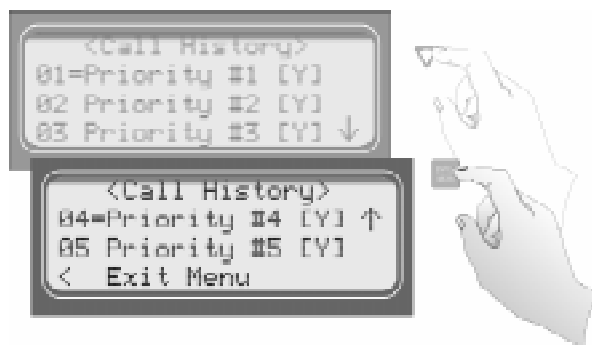







Figure 4-15 Call History Options

6. Press the  or  button to move through the call history menu choices. See Figure 4-15.
7. When the equal sign highlights the call history items you desire to print for this report  
press  or  to toggle the setting between Y (yes print) or N (don't print).
8. Press  to exit menu.

### How to Print System History

Follow these steps to print the system history:

1. Log on to the receiver (see Section 4.4.4 for log on procedure).

2. Press the  button to view the main menu items.

3. Press  for the printer menu. (See Figure 4-13.)

4. Press  for print report menu. (See Figure 4-14.)

5. Press  to print the system history.

6. Press  to exit menu.

## How to Print System Configuration

Follow these steps to print the system configuration:

1. Log on to the receiver (see Section 4.4.4 for log on procedure).

2. Press the  button to view the main menu items.



3. Press  for the printer menu. (See Figure 4-13.)

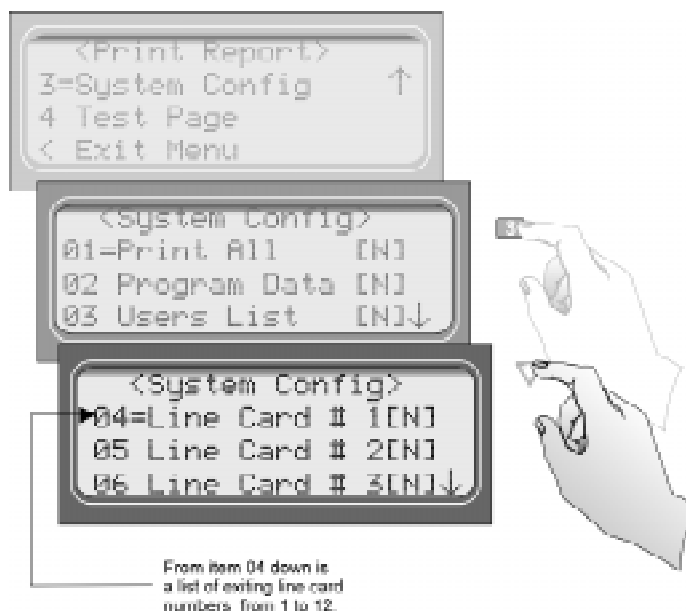

4. Press  for print report menu. (See Figure 4-14.)

5. Press  to view system configuration options. See Figure 4-16.



**Figure 4-16 System Configuration Print Items**

6. Press the  or  button to move through the system configuration print choices.

7. When the equal sign highlights an option press  or  to toggle the setting between Y (yes print) or N (don't print).

8. Press  to print the data and exit menu.

*Note: These choices are not saved to flash memory and will have to be chosen each time that print system configuration is entered.*

## How to Print a Test Page

Follow these steps to print a test page:

1. Log on to the receiver (see Section 4.4.4 for log on procedure).

2. Press the  button to view the main menu items.

3. Press  for the printer menu. (See Figure 4-13.)

4. Press  for print report menu. (See Figure 4-14.)

5. Press  to print a test page.

6. Press  to exit menu.

### 4.6.8.2 Edit Event Format

Edit event format allows you to configure what information will print on reports to the receiver.

Follow these steps to configure the report format:

1. Log on to the receiver (see Section 4.4.4 for log on procedure).

2. Press the  button to view the main menu items.

3. Press  for the printer menu. (See Figure 4-13.)

4. Press  for event format menu items. (See Figure 4-17.)

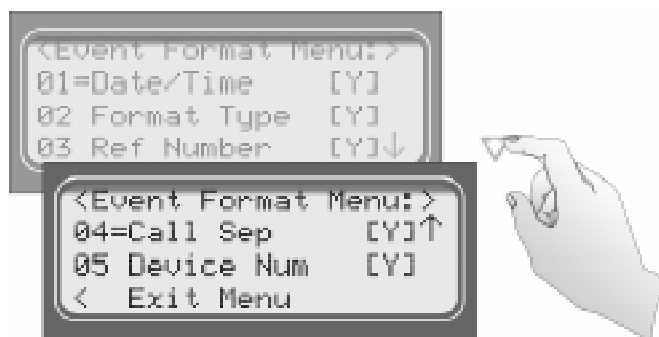





Figure 4-17 Event Format Menu Items

5. Press the  or  button to move through the event format choices. (See Table 4-6 for choice definitions)

**Table 4-7: Event Format Choices and Meaning**

Event Format Options	Choices	Meaning
Date/Time	Y (Yes)	Y = date and time will print for each report message to the printer.
	N (No)	N = Date and time will not print for each report message to the printer.
Format Type	Y (Yes)	Y = The reporting format type of the calling control panel will print for each report message to the printer.
	N (No)	N = The reporting format type of the calling control panel will not print for each report message to the printer.  <b>Note:</b> The Format Type will be listed as a number, which represents the format used for that communication. See
Reference Number	Y (Yes)	Y = The reference number will print for each report message to the printer.
	N (No)	N = the reference number will not print for each report message to the printer. (See Figure 4-8)
Call Separator	Y (Yes)	Y = Print a dashed-line between each message report to the printer.
	N (No)	N = Do not print a dashed-line between each message report to the printer.
Device Number	Y (Yes)	Y = Print the device number of the reporting message to the printer.
	N (No)	N = Do not print the device number of the reporting message to the printer.

6. When the equal sign highlights each option press  or  to toggle the setting between Y (yes print) or N (don't print).

*Note: These settings are saved to flash memory.*

7. Press  to exit menu.





### 4.6.8.3 Configure Printer

Depending on the printer you are using it may require that this be set to either carriage return or carriage return with a line feed.

Follow these steps to configure the printer:

1. Log on to the receiver (see Section 4.4.4 for log on procedure).

2. Press the  button to view the main menu items.

3. Press  for the printer menu. (See Figure 4-13.)

4. Press  for configure printer menu items.

The display will be flashing on the line terminator field.

5. Press the  or  button to toggle between CR or CRLF. (See Table 4-6.)

6. When the desired setting is flashing press .

The display will now flash on the offline time field.

7. Enter the desired time (from 01-99 seconds), 30 second maximum in UL applications.

8. Press .

The display will now flash on the switch delay time field.

9. Enter the desired time (from 01-99 seconds).

10. Press .

11. Press  to exit menu.

### 4.6.9 Program Menu

If program is selected from the main menu the system will enter into “Program Mode”. (See Section 4.5 for information on modes of operation.) In program mode you can program all the general options, line card options, and user list. (See Appendix A, Table A-1 for programming *Quick Chart*.)



Figure 4-18 Program Menu Items

### 4.6.10 Diagnostics Menu

The diagnostics menu items can be used while testing and troubleshooting the system.

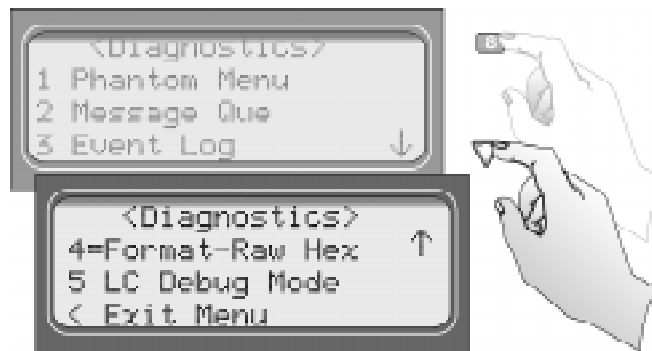

Figure 4-19 Diagnostics Menu Items

### 4.6.10.1 Phantom Menu

The phantom menu contains list of various communication format phantom signals (see Table 4-8) that can be used to test the receiver or automation software configurations. For example, you set a linecard parameters for a particular communications format and would know like to verify that this new configuration will communicate with other communication formats, you can send phantom signals in the formats you wish to test that linecard with.

**Table 4-8: Phantom Signals Formats List**

Choice	Format
01 DCS	DCS
02 CID	Contact ID
03 ITI	ITI format
04 BFSK	BFSK
05 A31 Task 1	3/1 format
06 A31 Checksum	3/1 format w/checksum
07 A41	4/1 format
08 A42	4/2 format
09 FSK0	FSK0
10 FSK1	FSK1
11 FSK2	FSK2
12 SIA D1	SIA D1
13 ADM42 Checksum	Ademco 4/2 format w/ checksum
14 SIA D1 Checksum	SIA D1 w/checksum
15 ACRON TOUCH TONE	Acron Touch Tone
16 ADM41 Checksum	Ademco 4/1 format w/ checksum
17 FBI 4+3+1	FBI 4+3+1

### 4.6.10.2 Message Que

Message Que gives a visual indication of how full is the message queue. It does this with both a percentage indication and a bar graph (made of \*'s). Each \* is approximately 5%.

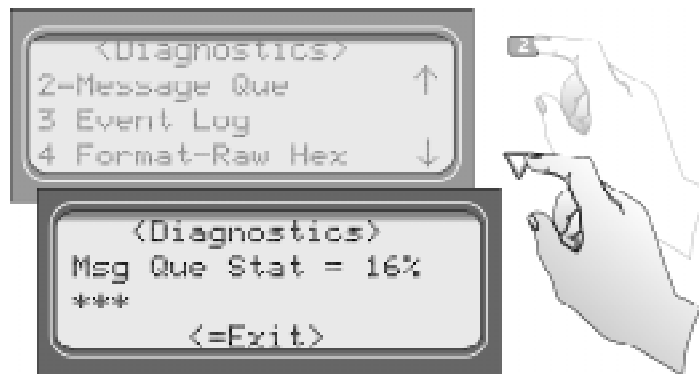

Figure 4-20 Message Queue Level

### 4.6.10.3 Event Log

Print Log allows you to print out a certain range of reference numbers to the port designated to diagnostics. This can be used to as a troubleshooting tool while correlating alarm messages from the receiver to the automation computer.

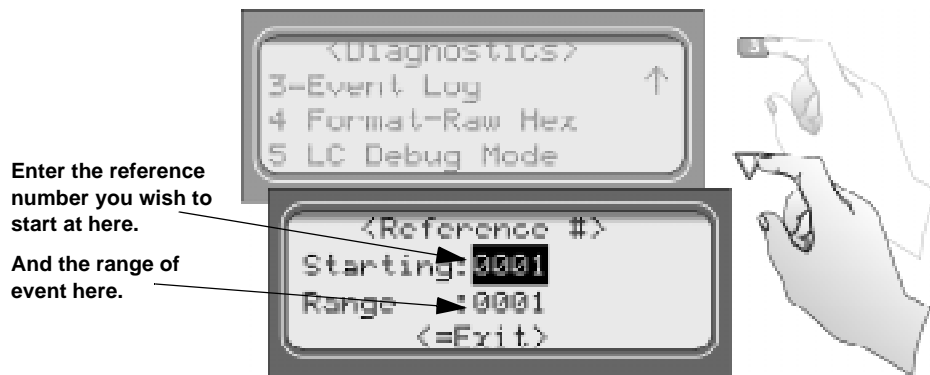

Figure 4-21 Event Log Display

For example, if the automation computer indicated a report that you are not familiar with, you would enter the reference number for that report in the event log and the raw data would be output to the diagnostic port. From the raw data you could determine what the signal was and make adjustment to the automation computer for future signals like that one.

#### 4.6.10.4 Format

Format designates the type of output you wish for the Event Log report. The output format can be in raw ASCII, a printer format, or one of the receivers automation communication formats (see Section 8 for automation protocols).

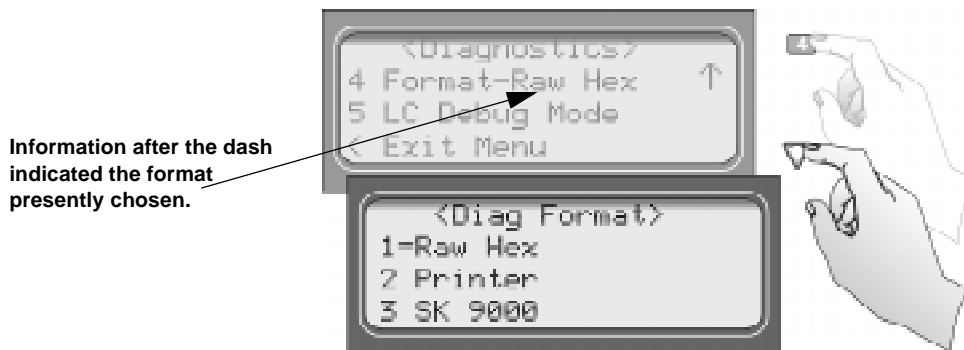

Figure 4-22 Diagnostic Formats

#### 4.6.10.5 LC Debug Mode

LC debug enables the receiver to generate detailed history of handshake sequences to the call buffer. This information can be used for troubleshooting.

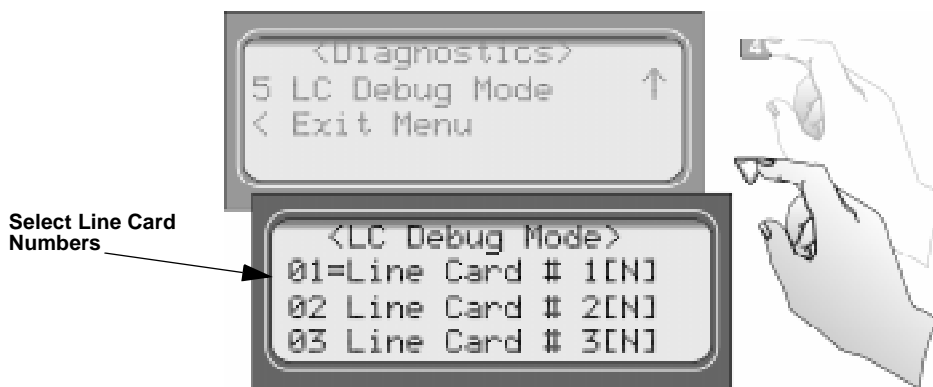





Figure 4-23 Select LC Debug Mode by Line Card

Use the  right arrow or  to toggle the line card selection between “Yes” or “No”.

Press  to exit and “Yes” to save changes.

## 4.7 Listen-In and Hang Up

*Note: See Section 2.3.2 for UL requirement on listen-in.*

This section explains how to operate the receiver for listen-in calls. Some panels that perform listen-in send a listen-in indicator included in the reported message to the receiver. Any panel that does not send this message must be added to the Listen-In Account List (see Section 5.4.2.3).

When a listen-in call is received by the 9800, the LCD display will indicate the account number and (depending on the panel) the listen-in timeout period. The listen-in LED on the linecard will be illuminated to confirm the line card indication.

### 4.7.1 Manual (Common) Listen-In Operation

Follow these steps to manually handle the listen call:

1. Press  .
2. Enter the line card number.
3. Pick up the telephone the listen-in call is on. See Figure 4-24 for a diagram of how the listen-in phone should be connected (in parallel) with the phone line of the line card.

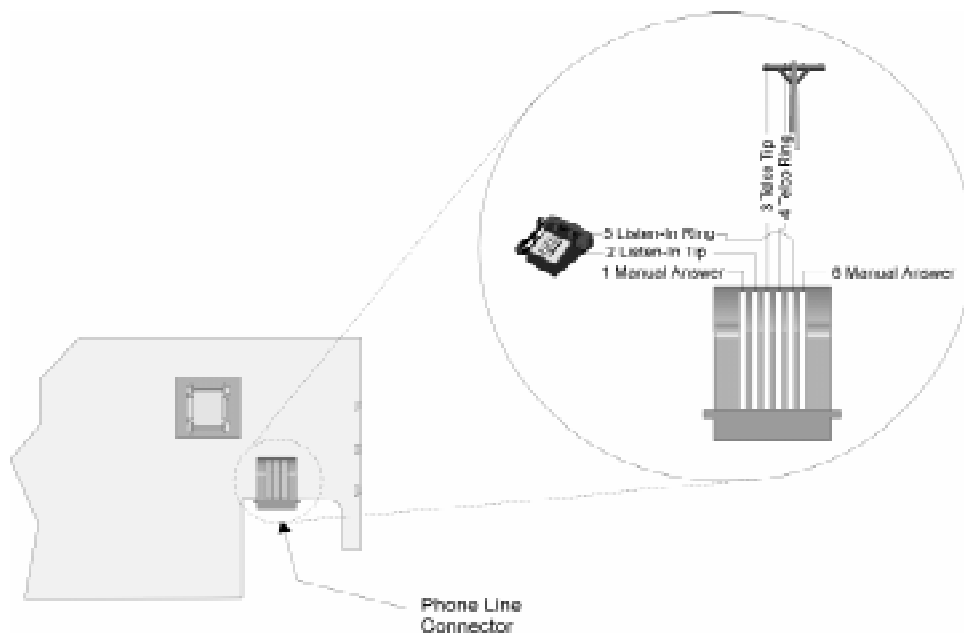

**Figure 4-24 Phone Connector Pin-Out and Listen-in Wiring Diagram**

4. Perform the listen-in procedures for that panel (refer to panel operation manual).

## 4.7.2 PBX Operation

Prior to performing listen-in functions on a PBX phone line system the receiver must be set up with the proper listen-in mode and PBX string. Refer to Sections 5.1 and 5.4.2.3 to properly program the receiver to handle PBX listen-in calls.

## 4.8 Testing the System

---

<b>IMPORTANT:</b>
-------------------

The 9800 should be tested regularly to ensure complete and proper operation.
--

Because there are so many variations in dialer parameters and phone line conditions, the only way to be absolutely certain that all subscribers can communicate with the 9800 is to test every subscriber's dialer individually. Subscribers must test their communicators every 30 days to make sure the 9800 receives the information.

When you install a new 9800, test every manufacturers' panels for each format. This is necessary because different manufacturers' panels may operate differently even if all panels use the same format.





---

## Section 5

# Programming

---

---

This section lists the programmable features in programming mode and the procedures for each of them. The options available are general options, line card options, and user options.

### 5.1 How to Enter Program Mode

---

Follow these steps to enter into program mode:

1. Log on to the receiver (see Section 4.4.4 for log on procedure).

2. Press the  button.

3. Press the  button.

The display will briefly display `Initializing`









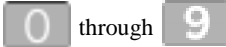

`Please wait . . .`

4. Select the option you wish to program. (See Section 5.2 for options.)

#### 5.1.1 Programming Fields

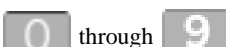
In program mode there are three types of programming fields that data can be entered into. Table 5-1 list the three types of fields and the various parameters associated with them.

**Table 5-1: Types of Programming Fields**

Type of Field	Control Keys	Comments
Numeric	 through  or   keys	These fields require a numeric entry only.
List	  keys	Predefined choices are put in a list and can be selected by pressing the up or down arrow keys.
Edit	 through  or   keys	Enter a number from the numeric keypad or enter any special characters by pressing the up or down arrow keys.

## 5.1.2 How to Maneuver Around in Program Mode

Figure 5-1 shows what keys on the touchpad are used to maneuver in program mode.

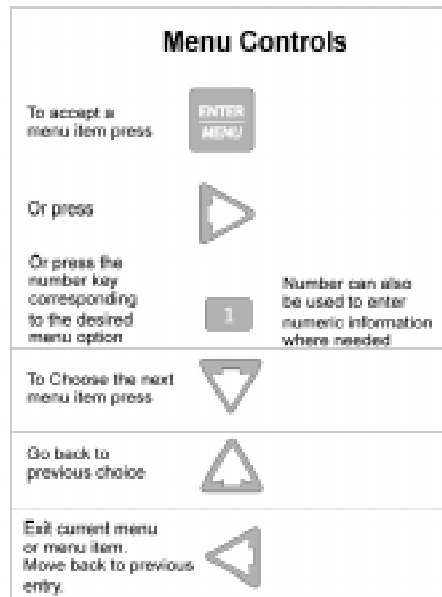

Figure 5-1 Programming Controls

## 5.2 Programming Choices

---

In programming mode your first set of choices are general options, line card options, and user list. (Each of these choices will be described in greater detail in the following sections.) Figure 5-2 shows what the display will look like before and after the down arrow is pressed.

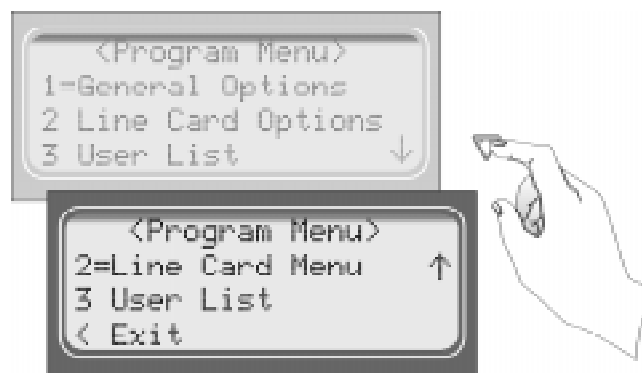

Figure 5-2 Program Menu Choices

## 5.3 General Options

---

The features available for programming under general options are operation mode, display options, communications, and system options.

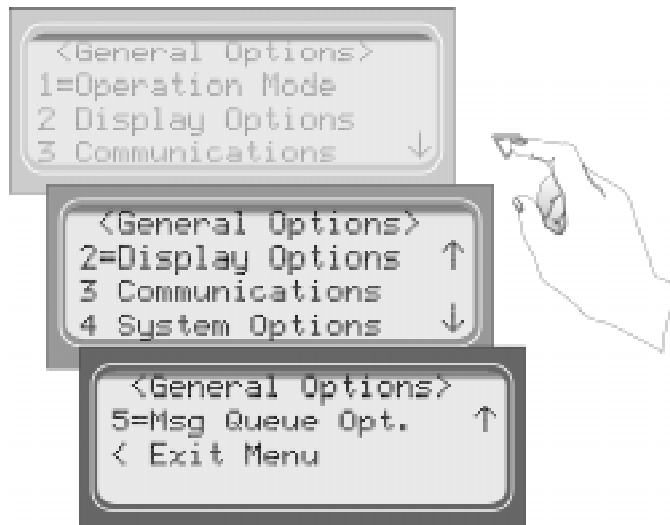

Figure 5-3 General Options Display

Table 5-2 list the available choices under General Options and gives a description of those choices.

**Table 5-2: General Options Items and Description**

General Options Items	Level 1 Choices	Level 2 Choices	Level 3 Choices	Comments	
Operation Mode	Manual			See Section 5.3.1 for additional information on Operation Modes.	
	Automatic				
	Log Only				
Display Options	Language	English		See 5.3.2.1.	
		español		Not available at this time	
	Time Display	AM/PM			AM/PM is used for 12 hour time clock displays. See 5.3.2.2.
		24 Hour			
	Date Format	M/D/Y			M = month, D = day, and Y = year. See 5.3.2.3.
		D·M·Y			
		Y-M-D			
	Daylight Savings	Yes			See 5.3.2.4.
		No			
	Edit ITI Options	Attempts		Yes	Affects printer output for ITI calls only.
				No	
		CPU Time		Yes	
				No	
		CPU Type		Yes	
				No	
	Panel Rev		Yes		
No					
Arming Level		Yes			
		No			
Sorted Events	Yes			Will sort events as defined in UL 864, Section 72.15F 1. Life Safety signals = fire, duress. 2. Property safety signals = burg. 3. Supervisory signals. 4. Trouble Signals. 5. All other signals. See 5.3.2.6.	
	No				
Hold Last Event	Yes			LCD will display the last or oldest unacknowledged event instead of the date/time display. See 5.3.2.7.	
	No				

**Table 5-2: General Options Items and Description**

General Options Items	Level 1 Choices	Level 2 Choices	Level 3 Choices	Comments
Communication	Port Functions	Com1	Unused/Automation/Printer/	Rules for Port Configuration: 1. Functions in Brackets [ ] will not appear unless “Automation” is selected for Com1 function. 2. Functions in { } will not appear unless “Printer” is selected in Com1 or Par. 3. A function may be selected only once in the 3 ports (only one printer, only one Diag, and so on). 4. All ports may be configured “Unused”. See Section 5.3.3 for additional information.
		Com2	Unused/[Auto Bkp]/[Auto Bkp Prn]/{Print Bkp}/Diag/Printer MeterMinder	
		Par	Unused/[Auto Bkp]/Printer/Diag MeterMinder	
	Com Port 1	Baud Rate	19200/9600/7200/4800/2400/1200/600/300/110	
		D (# Data Bits)	7, 8	
		S (# Stop Bits)	1, 2	
		P (Parity)	Even, Odd, Space, Mark, No	
		F (Flow Control)	Hdwr, None	None = no supervision
		Init String		See Section 5.3.3.4.
	Com Port 2	Same as Com Port 1		See Section 5.3.3.3.
	Par Port	Init String		See Section 5.3.3.4.
	Automation Config	Format	SIA CIS, SIA 2000, SK 9000, SK EXP, ITI Gen, ITIComp	See 5.3.3.5.
		Hex	Y = Enabled	
			N = Disabled	
		Heart Beat	Y = Enabled	
			N = Disabled	
	Time (of Heartbeat)	10-600 Seconds		
	Ack timeout	0-600 Seconds		

**Table 5-2: General Options Items and Description**

General Options Items	Level 1 Choices	Level 2 Choices	Level 3 Choices	Comments
Communication (Continued)	Annunciator Configuration	Printer	Yes or No	See Section 5.3.3.6.  Must be set to No for UL installations.
		Bkp Printer	Yes or No	
		Auto Comp	Yes or No	
		Bkp Auto Comp	Yes or No	
		Meter Minder	Yes or No	
		Battery	Yes or No	
		Line Card	Yes or No	
		Line Fault	Yes or No	
		AC Power	Yes or No	
		Buffer Full	Yes or No	
		Listen In	Yes or No	
	Call Pending	Yes or No		
	Aux Relay Cfg	Printer	Yes or No	See Section 5.3.3.7.  Must be set to No for UL installations.
		Bkp Printer	Yes or No	
		Auto Comp	Yes or No	
		Bkp Auto Comp	Yes or No	
		Meter Minder	Yes or No	
		Battery	Yes or No	
		Line Card	Yes or No	
		Line Fault	Yes or No	
		AC Power	Yes or No	
		Buffer Full	Yes or No	
Listen In		Yes or No		
Call Pending	Yes or No			
System Options	Battery Backup Cfg	No Battery Bkp		See Section 5.3.4.
		Battery Bkp		
		DC Bkp		
	Receiver ID No.	01-99		
	Auxiliary Relay Normal State	De-energized		
Energized				
Message Queue Options	% Warning Lvl	On: 10 to 99 %	75%	The percentage of how full the message queue can get before a trouble indication occurs.
		Off: 01 to 90%	50%	What percentage the message queue must go back down to in order to clear a trouble indication.
	Max Buf Limit	500 to 5000	1000	Used to set the maximum number of bytes in a call. This number is used to determine if a call is a runaway call.

### 5.3.1 Operation Mode

Operation mode chooses how the receiver will operate in normal mode (manual, automatic or log only operation). Table 5-3 breaks down the choices available under operation mode menu item.

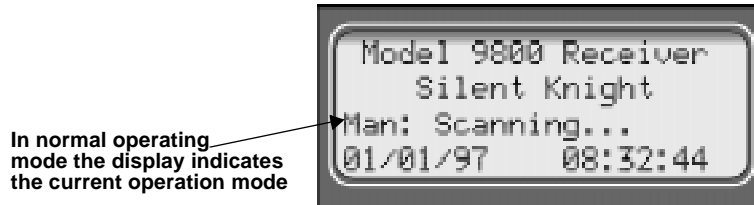

Figure 5-4 Normal Operating Mode Display Indicating Manual Operation

Table 5-3: Operation Mode Choices and Descriptions

Choices	Description	Default
Manual	Requires manual acknowledgments of each call or event from an operator.	✓
Automatic	All event information is sent directly to the automation computer and must be acknowledged by the automation software.	
Log Only	All event information is internally acknowledged and put into event history buffer.	

*Note: Defaults refer to settings from the factory. Once the receiver is programmed, the system will power up in the programmed operation mode.*

### 5.3.1.1 How to change the operation mode

Follow these steps to change the operation mode of the receiver:

1. Log on to the receiver. (See Section 4.4.4 for log on procedure.)

2. Press  button.



3. Press  for program menu.

The display will briefly display `Initializing`  
`Please wait . . .`

4. Press  to choose general options.

5. Press  to choose operation mode.

The current operation mode will flash in the display.

6. Press the  or  button to move through the operation mode choices.

*Note: Each additional press of the up or down arrow key will toggle the operation mode setting to the next choice.*

7. When the display flashes on the desired operation mode press .



### 5.3.2 Display Options

Display options lets you customize the visual outputs of the receiver. These items include language formats, the time display, how events are sorted to the LCD display, or whether or not to hold unacknowledged events. Table 5-4 lists the available choices and gives a description of those choices.



Figure 5-5 View of Display Options







Table 5-4: Display Options and Descriptions

Display Menu Items	Choices	Default	Comments
Language	English	✓	See Section 5.3.2.1 for step-by-step instructions.
	español		Not available at this time.
Time Display	AM/PM	✓	AM/PM is used for 12 hour time clock displays. See Section 5.3.2.2 for step-by-step instructions.
	24 hour		Military time standard. See Section 5.3.2.2 for step-by-step instructions.
Date Display	m/d/y	✓	m = month, d = day, and y = year.
	d'm'y		See Section 5.3.2.3 for step-by-step instructions.
	y-m-d		
Daylight Savings	Yes	✓	See Section 5.3.2.4 for step-by-step instructions.
	No		
Edit ITI Options	Attempts	No	
	CPU Time	No	
	CPU Type	No	
	Panel Rev	No	
	Arming Level	No	

**Table 5-4: Display Options and Descriptions**







Display Menu Items	Choices	Default	Comments
Sorted Event	Yes		Will sort events as defined in UL 864, Section 72.15F 1. Life Safety signals = fire, duress. 2. Property safety signals = burg. 3. Supervisory signals. 4. Trouble Signals. 5. All other signals.
	No	✓	Will display events as they are received.
Hold Last Event	Yes		LCD will display the last acknowledged event instead of the date/time display in the auto mode. In manual mode the display will show the oldest unacknowledged event.
	No	✓	

### 5.3.2.1 How to Change Language Display







1. Enter program mode. (See Section 5.1.)
2. Press  for general options.
3. Press  for display options.
4. Press  until the display flashes on the language format field.
5. Press the  or  button until the display flashes on the desired setting.
6. Press .

*Note: Only English format is available at this time.*







### 5.3.2.2 How to Change Time Format Display

1. Enter program mode. (See Section 5.1.)
2. Press  for general options.
3. Press  for display options.
4. Press  until the display flashes on the time format field.
5. Press the  or  button until the display flashes on the desired setting.
6. Press .

### 5.3.2.3 How to Change Date Format Display

1. Enter program mode. (See Section 5.1.)
2. Press  for general options.
3. Press  for display options.
4. Press  until the display flashes on the date format field.
5. Press the  or  button until the display flashes on the desired setting.
6. Press .

### 5.3.2.4 How to Turn “On” or “Off” Daylight Savings.







1. Enter program mode. (See Section 5.1.)
2. Press  for general options.
3. Press  for display options.
4. Press  until the display flashes on the daylight savings field.
5. Press the  or  button until the display flashes on the desired setting.
6. Press .

### 5.3.2.5 How to Edit ITI Options







If one of the following ITI options is turned on (set to Yes) then the LCD and printer outputs will include that information.

- Attempts
- CPU Time
- CPU Type
- Panel Rev
- Arming Level







To set these display options follow these steps:

1. Enter program mode. (See Section 5.1.)
  2. Press  for general options.
  3. Press  for display options.
  4. Press  until the display flashes on the <ITI> savings field.
  5. Press  .
  6. Press the  or  button until the equal sign is on the desired option.
  7. Press  to change the setting of that option.
- Note: Additional presses of the enter button will toggle the setting between Yes and No.*
8. Repeat steps 6 and 7 for any other ITI display options you wish to edit.

### 5.3.2.6 How to Set Sorted Events

1. Enter program mode. (See Section 5.1.)
2. Press  for general options.
3. Press  for display options.
4. Press  until the display flashes on the sort event field.
5. Press the  or  button until the display flashes on the desired setting.
6. Press .

### 5.3.2.7 How to Set Hold Last Event

1. Enter program mode. (See Section 5.1.)
2. Press  for general options.
3. Press  for display options.
4. Press  until the display flashes on the hold last event field.
5. Press the  or  button until the display flashes on the desired setting.
6. Press .

### 5.3.3 Communications

In the communication option the installer can configure the communication ports, automation configuration, annunciator configurations, and the auxiliary relay configurations.

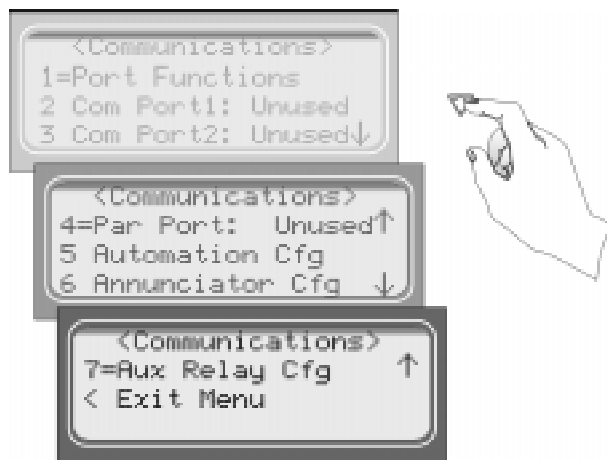

Figure 5-6 Communications Options Menu

Table 5-5 list the available choices and gives a description of those choices.

Table 5-5: Communications Options and Description

Communications Menu	Choices	Options	Default	Comments	
Port Functions	Com1	Unused	✓	<b>Rules for Port Functions:</b> 1. Functions in Brackets [ ] will not appear unless “Automation” is selected for Com1 function. 2. Functions in { } will not appear unless “Printer” is selected in Com1 or Par. 3. A function may be selected only once in the 3 ports (only one printer, only one Diag, and so on). 4. All ports may be configured “Unused”. 5. Only Com port 1 can be set as the primary automation port.	
		Automation			
		Printer			
	Com2	Unused	✓		
		Diagnostics			Would output raw Hex-ASCII code.
		Printer			English output to a printer.
		[Auto Bkp]			Would act as a backup automation port if a fault occurred with the primary automation port.
		[Auto Bkp Prn]			Would act as a backup print output port if a fault occurred with the automation port.
		{Print Bkp}			Would act as a backup printer port if a fault occurred with the primary printer port.
		MeterMinder			Would output MeterMinder output format.

Table 5-5: Communications Options and Description

Communications Menu	Choices	Options	Default	Comments	
Port function (Continued)	Par	Unused	✓		
		Diagnostics		Would output raw Hex-ASCII code.	
		Printer		English output to a printer.	
		[Auto Bkp Prn]		Would act as a backup print output port if a fault occurred with the automation port.	
		MeterMinder		Would output MeterMinder output format.	
Com Port 1	Baud	19200	✓		
		9600			
		7200			
		4800			
		2400			
		1200			
		600			
		300			
		110			
	D (# Data Bits)	7			
		8	✓		
	S (# Stop Bits)	1	✓		
		2			
	P (Parity)	Even			
		Odd			
		Space			
		Mark			
None		✓			
F (Flow)	Hdwr	✓		Unidirectional communication	
	None				
	Init Str (Initialization String)			Two 20 character ESC command sequences. See Section 5.3.3.4 for step-by-step instructions.	
Com Port 2				Same as Com Port 1	
Par Port (Parallel Port)	Init Str (Initialization String)			Two 20 character ESC command sequences. See Section 5.3.3.4 for step-by-step instructions.	

**Table 5-5: Communications Options and Description**

Communications Menu	Choices	Options	Default	Comments
Automation Cfg	Format	SIA CIS		See Section 5.3.3.5 for programming steps.
		SIA 2000		SIA 2000 output same as SIA CIS output.
		SK 9000	✓	See Section 8 for more information on automation formats.
		SK EXP		
		ITI Gen		
		ITIComp		
	Hex	Y = Enabled		When Hex Mode is enabled, any call data that is determined to be bad data will be output in Hex format.
		N = Disabled	✓	
	Heartbeat	Y = Enabled		See Section 5.3.3.5 for programming steps.
		N = Disabled	✓	
Time (of Heartbeat)	10-600 seconds	0 sec	How often a supervisory signal (a heartbeat) is sent to the automation computer. See Section 5.3.3.5 for programming steps.	
Ack Timeout	0-600 seconds	10 sec	15 seconds or less in UL applications. See Section 5.3.3.5 for programming steps.	
Annunciator Cfg	Printer	Yes	✓	Yes = will annunciate if an event, trouble or fault condition occurs.
		No		
	Bkp Printer	Yes	✓	No = no annunciation if an event, trouble or fault condition occurs.
		No		
	Auto Comp	Yes	✓	See Section 5.3.3.6 for programming steps.
		No		
	Bkp Auto Comp	Yes	✓	
		No		
	Meter Minder	Yes	✓	
		No		
	Battery	Yes	✓	
		No		
	Line Card	Yes	✓	
		No		
	Line Fault	Yes	✓	
		No		
	AC Power	Yes	✓	
		No		
	Buffer Full	Yes	✓	
		No		
Listen In	Yes	✓	Must be set to No for UL installations.	
	No			
Call Pending	Yes	✓		
	No			









**Table 5-5: Communications Options and Description**

Communications Menu	Choices	Options	Default	Comments
Aux Relay Cfg	Printer	Yes	✓	Yes = will annunciate if an event, trouble or fault condition occurs. No = no annunciation if an event, trouble or fault condition occurs. See Section 5.3.3.7 for programming steps.
		No		
	Bkp Printer	Yes	✓	
		No		
	Auto Comp	Yes	✓	
		No		
	Bkp Auto Comp	Yes	✓	Must be set to No for UL installations.
		No		
	Meter Minder	Yes	✓	
		No		
	Battery	Yes	✓	
		No		
	Line Card	Yes	✓	
		No		
	Line Fault	Yes	✓	
		No		
	AC Power	Yes	✓	
		No		
	Buffer Full	Yes	✓	
		No		
Listen In	Yes	✓		
	No			
Call Pending	Yes	✓		
	No			







### 5.3.3.1 How to Set Up Port Function

Port functions set up how each of the communication ports will be used. Before you start to set up the port functions review the rules for port functions in Table 5-5.

1. Enter program mode. (See Section 5.1.)
2. Press  for general options.
3. Press  for communications.
4. Press  to set port functions.
5. Press the  or  button until the display flashes on the desired port setting.
6. Press  .
7. Repeat steps 5 through 6 until all port functions are set.
8. Press  to exit menu.





### 5.3.3.2 How to set Com Port 1 Parameters

Set the baud rate, the number of data bits, number of stop bits, the parity, and the flow control (see Table 5-5 for choice details).

1. Enter program mode. (See Section 5.1.)
  2. Press  for general options.
  3. Press  for communications.
  4. Press  to set Com Port1 parameters.
  5. Press the  or  button until the display flashes on the desired port setting.
  6. Press  .
- Note: See “How to Edit Init String” in Section 5.3.3.4.*
7. Repeat steps 5 through 6 until all parameters are set.
  8. Press  to exit menu.

### 5.3.3.3 How to Set Com Port 2 Parameters

Set the baud rate, the number of data bits, number of stop bits, the parity, and the flow control (see Table 5-5 for choice details).

1. Enter program mode. (See Section 5.1.)
2. Press  for general options.
3. Press  for communications.
4. Press  to set Com Port2 parameters.
5. Press the  or  button until the display flashes on the desired port setting.

6. Press  .

*Note: See “How to Edit Init String” in Section 5.3.3.4.*

7. Repeat steps 5 through 6 until all parameters are set.
8. Press  to exit menu.

### 5.3.3.4 How to Edit Init String (Com 1, Com 2, and Parallel Port)

An initialization string can be used to customize the output to the device connected to a port on the receiver.

For example, you can skip over perforations, set proportional spacing, or condense the print output to a printer.

*Note: Refer to the user manual, of the device connected to the receiver, for special command sequences.*

Follow these step to insert an initialization string:

1. Press  at the flashing <Init Str> field.

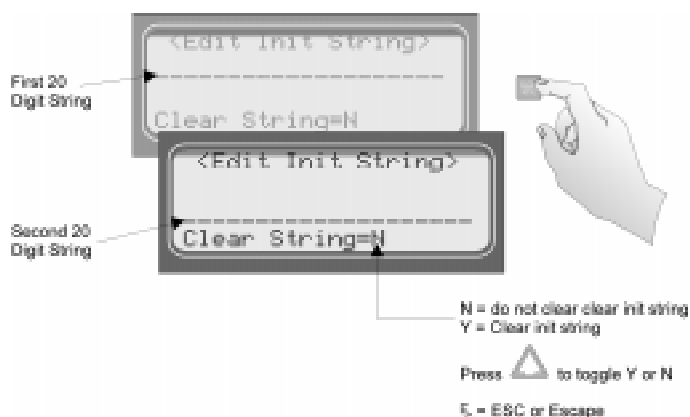

Figure 5-7 Initialization String Display



2. Press the  or  button until the desire character flashes.

Table 5-6: Initialization String Characters

Character	Description
0-9	Numeric characters, which can be entered from the touchpad or up/down arrows.
a-z and A-Z	Alpha characters entered with the up/down arrows.
: _ - . , & * # ? E_C and space bar.	Special Characters entered with the up/down arrows.

3. Press , the next character position will flash.
4. Repeat steps 2 and 3 until the desired sequence is complete.

5. Press .

6. Repeat steps 2 through 5 for the second string.

**To clear an init string:**

1. At the Clear String=N field, press  until the desired option flashes.  
See Figure 5-7.

2. Press  .







3. Press  to exit menu.

**5.3.3.5 How to Set Automation Communication**

Through this option the automation communication format and parameters can be set up. (See Table 5-5 for format choices.)

**How to Set the Format**

Follow these steps to set the automation communication format.









1. Enter program mode. (See Section 5.1.)
2. Press  for general options.
3. Press  for communications.
4. Press  to setup automation configuration.
5. Press the  or  button until the display flashes on the desired port setting.
6. Press  .
7. Press  if you wish to exit menu or continue with heartbeat.

### How Enable or Disable Hex Mode

When Hex Mode is enabled, any call data that is determined to be bad will output in a Hex format. This feature is only available if SK 9000 automation protocol is selected.

*Note: This feature should be disabled if the automation software package that you are using does not recognize Hex data.*







Follow these steps to enable or disable heartbeat:

1. Enter program mode. (See Section 5.1.)
2. Press  for general options.
3. Press  for communications.
4. Press  to set up automation configuration.
5. Press  until the heartbeat field is flashing.
6. Press the  or  button until the display flashes on the desired setting.
7. Press  .
8. If you wish to exit, press  until you exit this menu.

### How Enable or Disable Heartbeat

A heartbeat is a supervisory signal continually test the communication link between the automation computer and the receiver.

Follow these steps to enable or disable heartbeat:

1. Enter program mode. (See Section 5.1.)
2. Press  for general options.
3. Press  for communications.
4. Press  to set up automation configuration.
5. Press  until the heartbeat field is flashing.
6. Press the  or  button until the display flashes on the desired setting.

7. Press  .

8. If you wish to exit, press  until you exit this menu.

### Time (Period of Heartbeat)

This option determines how often the heartbeat is sent to the automation computer. For example, if the time is set to 60 seconds (default setting) then a heartbeat will be sent every 60 seconds.

Follow these steps to set the time period or the heartbeat:



1. Enter program mode. (See Section 5.1.)

2. Press  for general options.

3. Press  for communications.

4. Press  to set up automation configuration.

5. Press  until the time field is flashing.

6. From the number keypad enter the desired number or press the  or  button until the display flashes on the desired setting.









7. Press  .

8. If you wish to exit, press  until you exit this menu.

### Ack Time (Acknowledge Time)

The acknowledge time is the duration that the receiver will wait for a response from the automation computer after a data packet has been sent. Data packets include all reports and heartbeats.

Follow these steps to set the time period or the heartbeat:





1. Enter program mode. (See Section 5.1.)
2. Press  for general options.
3. Press  for communications.
4. Press  to set up automation configuration.
5. Press  until the ack time field is flashing.
6. From the number keypad enter the desired number or press the  or  button until the display flashes on the desired setting.
7. Press .
8. If you wish to exit, press  until you exit this menu.



### ITI Options (Only Visible if ITI Gen or ITIComp Formats are Chosen)

These are options particular to the ITI automation format and can only be edited if one of these formats is used to communicate with the automation computer. See Sections 8.4 and 8.5.

Follow these steps to set the ITI options:





1. Enter program mode. (See Section 5.1.)
2. Press  for general options.
3. Press  for communications.
4. Press  to set up automation configuration.
5. Press  until the ack <ITI> field is flashing.
6. Press  .

**Table 5-7: ITI Automation Format Options**





Option	Choices	Default	Meaning	Comments
Log Recs	Y (Yes)	N	Log records identify the time and date of a incoming report.	
	N (No)			
XID	Y (Yes)	N	Extended panel Identification code.	See 8.4.2.2.
	N (No)			
SupCh		s	Supervisory Character is sent from the automation computer. The receiver will respond with an OKAY or supervisory record. See Sections 8.4.5 and 8.5.5.	
No Data		0	Identifies the no data character in the log record.	

*Note: ITI automation formats are covered in greater detail in Sections 8.4 and 8.5.*





### Log Recs (For ITI Formats):

1. At the flashing Log Recs field press the  or  button until the display flashes on the desired setting.
2. Press  .
3. If you wish to exit, press  until you exit this menu.





### XID (Extended ID for ITI Panels):

1. At the flashing XID field press the  or  button until the display flashes on the desired setting.
2. Press  .
3. If you wish to exit, press  until you exit this menu.

### SupCh (Supervisory Character):

1. At the flashing SupCh [e] field press the  or  button until the display flashes on the desired setting.
2. Press  .
3. If you wish to exit, press  until you exit this menu.

### NoData (No Data Character for Log Record):



1. At the flashing NoData[ ] field enter a digit from 0-9 from the touchpad or press the  or  button until the display flashes on the desired setting.
2. Press  .
3. If you wish to exit, press  until you exit this menu.

### 5.3.3.6 How to Configure the On-board Annunciator Outputs

Program what will give a trouble annunciation or what will not annunciate from the on-board annunciator.

1. Enter program mode. (See Section 5.1.)
2. Press **1** for general options.
3. Press **3** for communications.
4. Press **6** to set annunciator configuration.

A list of the annunciator output options appears.

5. Press the  or  button to move through the annunciator output options.

6. When the equal sign highlights the option you wish to change, press  .

*Note: Additional presses of the enter button toggle the setting between “yes” or “no”. See Table 5-8.*

7. Repeat steps 5 through 6 for all annunciator options you wish to change. See Table 5-8 for list of additional options.

**Table 5-8: On-board Annunciator and Auxiliary Relay Options**



Option	Choices	Comments
Printer	Y (Yes)	Y = The on-board annunciator will beep if there is an error condition. N = No on-board annunciation if an error condition exist.
	N (No)	
Bkp Printer	Y (Yes)	
	N (No)	
Auto Comp	Y (Yes)	
	N (No)	
Bkp Auto Comp	Y (Yes)	
	N (No)	
MeterMinder	Y (Yes)	
	N (No)	
Battery	Y (Yes)	
	N (No)	
Line Card	Y (Yes)	
	N (No)	
Line Fault	Y (Yes)	
	N (No)	
AC Power	Y (Yes)	
	N (No)	
Buffer Full	Y (Yes)	
	N (No)	
Listen In	Y (Yes)	
	N (No)	
Call Pending	Y (Yes)	
	N (No)	

### 5.3.3.7 How to Configure the Auxiliary Relay Outputs

Program what will give a trouble output to the auxiliary relay contact. (To program the normal state of the auxiliary relay see Section 5.3.4.)

1. Enter program mode. (See Section 5.1.)
2. Press **1** for general options.
3. Press **3** for communications.
4. Press **7** to set relay configuration.

A list of the relay output options appears.

5. Press the  or  button to move through the relay output options.

6. When the equal sign highlights the option you wish to change, press  .

*Note: Additional presses of the enter button toggle the setting between “yes” or “no”. See Table 5-8.*

7. Repeat steps 5 through 6 for all relay options you wish to change. See Table 5-8 for list of additional options.

### 5.3.4 System Options

In system options you can configure the backup battery configuration, the receiver ID number, and the normal state of the auxiliary relay.

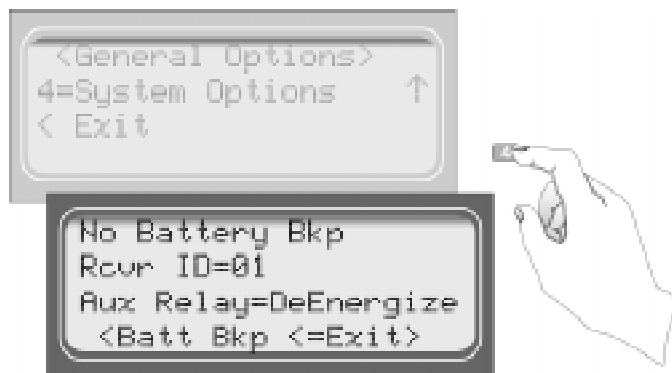

**Figure 5-8 System Options Display**





Table 5-9 list the available choices and gives a description of those choices.

**Table 5-9: System Options**

System Options Menu	Choices	Default	Comments
Battery Backup Cfg	No Battery Bkp	✓	No charging current applied to battery circuit. Receiver will not test battery output or give trouble annunciations.
	Battery Bkp		Charging current applied to battery circuit.
	DC Bkp		No charging current applied to battery circuit. Typically used for systems that use a UPS (uninterrupted power supply) for backup battery power.
Receiver ID	01-99	01	
Aux Relay Normal State	De-energized	✓	See Section 5.3.4.3 for auxiliary relay output options.
	Energized		

### 5.3.4.1 How to Change Backup Battery Setting

Through system options the backup battery can be configured for the type of backup battery your installation site requires.





1. Enter program mode. (See Section 5.1.)
2. Press  for general options.
3. Press  for system options.
4. Press the  or  button until the display flashes on the desired setting.
5. Press .

#### To Exit:

Press  until you return to the main menu.

### 5.3.4.2 How to Set the Receiver ID Number

In large central stations where calls may be coming in on several receivers at once, the automation software will need to identify which receiver it received a call from. This will help in troubleshooting if a problem occurred with the automation system or receiver.

1. Enter program mode. (See Section 5.1.)
2. Press  for general options.
3. Press  for system options.
4. Press .
- The display will flash on the receiver ID number: Rcvr ID=
5. Enter the desired receiver ID number (a number from 01 to 99).
6. Press .

#### To Exit:

Press  until you return to the main menu.



### 5.3.4.3 How to Set the Normal State of the Auxiliary Relay Contact

The auxiliary relay contact is a Form C relay. This feature allows you to set the state of the auxiliary relay normally open contact when power is applied to the receiver.

1. Enter program mode. (See Section 5.1.)
2. Press **1** for general options.
3. Press **4** for system options.

4. Press  .

The display will flash on the auxiliary relay setting: Aux Relay=**Energized**

5. Press the  or  button until the display flashes on the desired setting.

6. Press .

#### To Exit:

Press  until you return to the main menu.

### 5.3.5 Message Queue Options

Set the percentage of how full the message queue must be before a “Message Queue Warning” and “Message Queue Warning Restore” occur. See Section 7 for trouble messages.

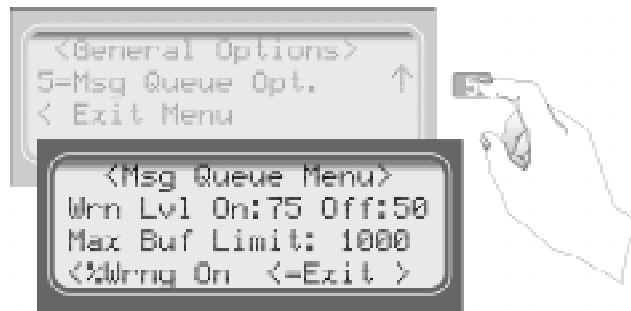



**Figure 5-9 Message Queue Display**

*Note: The “Warning On” can be set from 10% to 99%, the “Warning Off” can be set from 1% to 90%. A minimum separation of 5% will be set between the On % and the Off %. For example, if the “Warning On” is set to 82% the “Warning Off” maximum setting can be 77%.*

### 5.3.5.1 Set the Message Queue Warning On level

Set the percentage of how full the message queue can get before the receiver indicates a “Message Queue Warning” condition.

1. Enter program mode. (See Section 5.1.)
2. Press  for general options.
3. Press  for message queue options.
4. Enter the level (in %) you wish the receiver message queue to get before it will indicate a message queue warning.



5. Press  .

#### To Exit:

Press  until you return to the main menu.

### 5.3.5.2 Set the Message Queue Warning Off Level

Set the percentage level where the receiver will indicate a restore condition for a “Message Queue Warning”.

1. Enter program mode. (See Section 5.1.)
2. Press  for general options.
3. Press  for message queue options.
4. Press  until the display flashes on the **Off** field.
5. Enter the level (in %) you wish the receiver message queue to get before it will indicate a message queue warning restore.

6. Press  .



#### To Exit:

Press  until you return to the main menu.



### 5.3.5.3 Set the maximum Buffer Limit

Used to set the maximum number of bytes in a call. This number is used to determine if a call is a runaway call.

1. Enter program mode. (See Section 5.1.)
2. Press **1** for general options.
3. Press **5** for message queue options.
4. Press  until the display flashes on the Max Buf Limit field.
5. Press .

#### To Exit:

Press  until you return to the main menu.

## 5.4 Line Card Menu

---

Through the line card menu you can add a new line card, edit, clear, or view existing line cards.

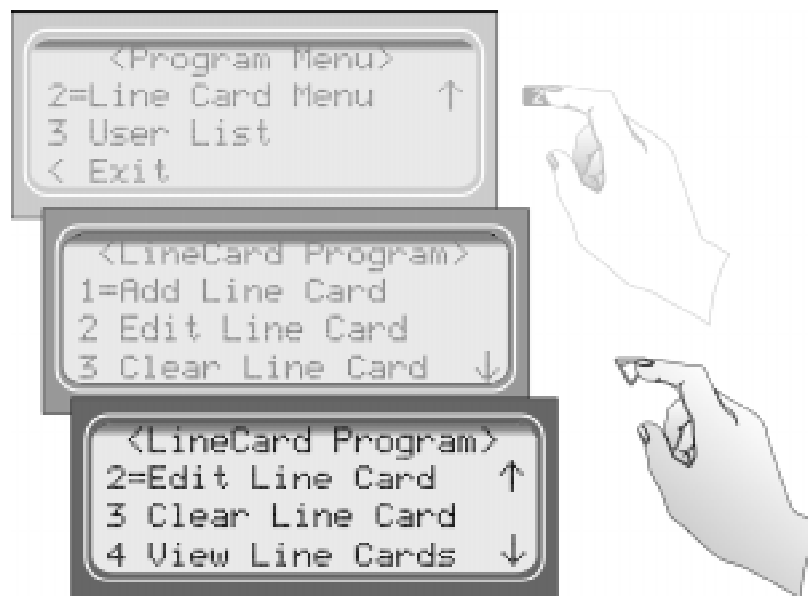

Figure 5-10 Choosing Line Card Menu and Line Card Program Menu Items

Table 5-10 lists the menu options available under line card menu.

**Table 5-10: Line Card Menu Options**

Line Card Menu	Choice	Choice	Choice	Default	Comments
Add Line card	Line card #	Use Defaults			
		Copy Existing			
Edit Line Card	Handshake Sequence	Sequence Number	1	See the corresponding numbers below.	The order in which the line card will output different handshakes. For more information see page 5-40.
			2		
			3		
			4		
			5		
			6		
		Handshake Group	2225Hz	1	Number in default column indicate the defaults per handshake sequence number. For more information see page 5-40
			1400Hz	4	
			1400_2300Hz	2	
			BFSK_1400Hz		
			BFSK_2300Hz		
			4/1 1400Hz	6	
			4/1 2300Hz	5	
			1400 Even		
			2300 Even		
			VEMS Term		
			Not Used		
			2300Hz	3	
		Handshake Delay	0-255 In 50ms periods	1. 010 (500ms)	For more information see page 5-41
				2. 002 (100ms)	
				3. 002 (100ms)	
				4. 002 (100ms)	
				5. 002 (100ms)	
				6. 002 (100ms)	
Handshake Duration	0-255 In 10ms periods	1. 090 (900ms)	For more information see page 5-41		
		2. 010 (100ms)			
		3. 100 (1 sec)			
		4. 100 (1 sec)			
		5. 100 (1 sec)			
		6. 100 (1 sec)			

Table 5-10: Line Card Menu Options

Line Card Menu	Choice	Choice	Choice	Default	Comments	
Edit Line Card (Continued)	Handshake Sequence (Continued)	Handshake Wait	0-255 In 50ms periods	1. 064 (3.2 sec)	For more information see page 5-42	
				2. 010 (500ms)		
				3. 064 (3.2 sec)		
				4. 064 (3.2 sec)		
				5. 064 (3.2 sec)		
				6. 064 (3.2 sec)		
		Handshake Acknowledge Duration	0-255 In 10ms periods	1. 075 (750ms)		For more information see page 5-42
				2. 055 (550ms)		
				3. 100 (1 sec)		
				4. 100 (1 sec)		
				5. 100 (1 sec)		
				6. 100 (1 sec)		
	Line Options	Direct	Y (Yes)		Y = dedicated or direct connect phone line. N = used for standard phone lines. See page 5-43 for more information.	
			No (No)	✓		
		Number of Rings	000-255	002	If caller ID is turned on (see Section 5.4.2.5), rings should be set to 2.	
		On time	1-255 in 50ms periods	010 (500ms)	See page 5-44 for more information.	
		Off time	1-255 in 50ms periods	010 (500ms)	See page 5-45 for more information.	
		Threshold	1-15 in 2.0 VDC steps	08 (16.0VDC)	See page 5-45 for more information.	
		Sample Time	0-255 seconds	020 (20 Sec)	See page 5-46 for more information.	
	Listen In	Listen Mode	Not Used	✓	See page 5-47 for more information. Must not be used in UL installations.	
			Common			
PBX						
PBX String edit			None	See page 5-48 for more information.		
Timeout		0-255	0	See page 5-49 for more information.		
Listen In account edit	Add Account	None		See page 5-49 for more information.		
	Edit Account					
	Clear Account					
Trap List	Add Account	Enter Account #	None	See page 5-51 through page 5-52 for more information.		
	Edit Account	Choose Account				
	Clear Account	Choose Account				

**Table 5-10: Line Card Menu Options**

Line Card Menu	Choice	Choice	Choice	Default	Comments
Edit Line Card (Continued)	Misc. Line Options	Echo Suppress	Y (Yes)		Outputs a 2 second 2025Hz tone to disable echo suppression equipment that may interfere with modem formats.
			N (No)	✓	
		Caller ID	Yes	✓	The Caller ID information will only be sent on incoming call messages that contain no data. If the call message contains any data (valid or invalid) no Caller Id information will be output.
			No		
		Billing Delay	Y (Yes)		Initiates a 2 second delay at the start of each call before the handshake delay.
			N (No)	✓	See page 5-54 for more information.
	Hunt Group	00-99	00	Allows multiple line cards to report under the same group number to the automation software.	
	ITI Options Menu	ITI SCode Menu	Default SCode	12345	Used in communication locking on ITI panels.
			Add Acct/ SCode	None	See Section 5.3.2.5.
			Edit Acct/ SCode	None	See Section 5.3.2.5.
			Clear Acct/ SCode	None	See Section 5.3.2.5.
			Add SCode Table	None	See Section 5.3.2.5.
			Clear SCode Table	None	See Section 5.3.2.5.
		Date/Time Flag	Requested	✓	
			Always		
		ITI 300 Baud	Yes		If enabled, the receiver will attempt to negotiate 300 baud communication with ITI panels that support 300 baud communication. See 5.4.2.5 for programming steps.
			No	✓	
	Copy Line Card(s)	Use Defaults	Choose Line card(s) #	Choose Line card(s) # that you wish to be programmed to factory defaults.	
		Copy Existing	Choose Line card # of Source & target Line Card	Copy the programming of one line card (source) and paste it into one or several (target) line cards.	
	Clear Line Card	Choose line card #		Deletes a line card from the receiver.	
	View Line Card			Views what line cards are installed.	

### 5.4.1 Add Line Card

To program in a new line card follow these steps:

1. Install the new line card. (See Section 3.5.)
2. Log on to the receiver. (See Section 4.4.4 for log on procedure.)

3. Press  button.

4. Press  for program menu.

The display will briefly display Initializing  
Please wait . . .

5. Press  to choose line card menu.

6. Press  to add a new line card.

The Display will show <Add Line Card> \_ \_  
Enter Line card #:

7. Enter the slot number of the line card being added (1-12).

8. Press  button.

9. Choose  to use line Card defaults.

or

10. Press  to use the programming of another line card.

### 5.4.2 Edit Line Card

To edit an existing line card follow these steps:

1. Log on to the receiver. (See Section 4.4.4 for log on procedure.)

2. Press  button.

3. Press  for program menu.

The display will briefly display Initializing  
Please wait . . .

4. Press  to choose line card menu.

5. Press **2** to edit line card.

The display will show a list of the existing line cards.

6. Press the  or  arrow buttons to move through the available list.

7. When the equal sign highlights the line card you wish to edit:

Press  .

The display will show a list of choices. Table 5-11 lists these choices and a brief description.

**Table 5-11: Edit Line Card List Items and Description**

Edit Line Card List	Description
1 Handshake Seq	This function is used to program the handshake order and parameters for this line card.
2 Line Options	Used to set number of rings, ring on/off duration, threshold voltage, and sample time.
3 Listen In	Used to program the parameters for the listen in (two-way voice communication) feature if used. Must not be used in UL installations.
4 Trap List	Used to set up accounts that need to be trapped such as panel which must be sent to a down loading computer for programming or updating.
5 Misc. Line Opt.	Used to program hunt group number, enable or disable echo suppression and billing delay.

### 5.4.2.1 Handshake Sequence

Each line card is intelligent enough to determine what format is being sent from a reporting panel. You only need to program the handshake order and parameters for each line card. A line card will initiate up to four different types of handshake tone groups. The order in which the receiver sends out these handshake signals can be changed in this program location for each line card. Table 6-1 in Section 6 lists the proper handshake to use for the type of communication format you are using with a panel.

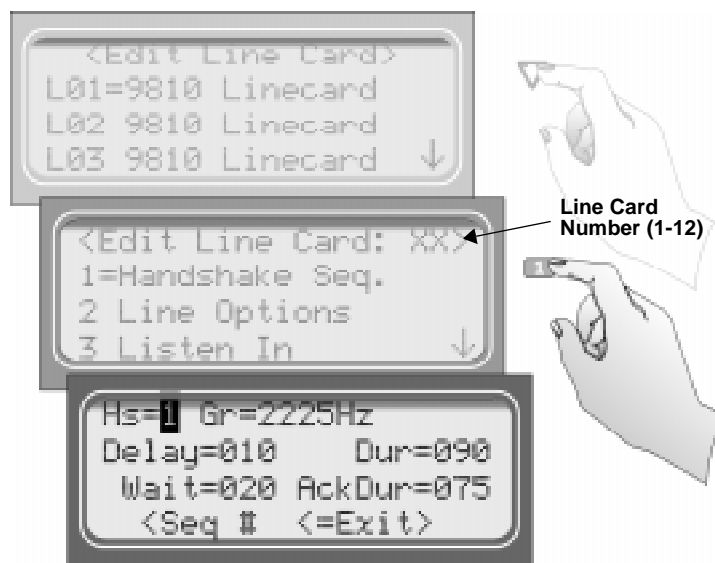

**Figure 5-11 Handshake Sequence Menu**

Follow these steps to change the handshake order and or the parameters associated with the handshake.



### To Change the Handshake Sequence Number:

Handshake sequence sets the order in which the receiver will send out handshakes.

1. Follow the procedures in Section 5.4.2.

2. Press **1** for handshake sequence menu.

When display flashes on the Seq# (see Figure 5-11).

3. Press the  or  button to change the ordered handshake number.

1 = the first handshake tone sent 2 = the second handshake tone to be sent and so on.

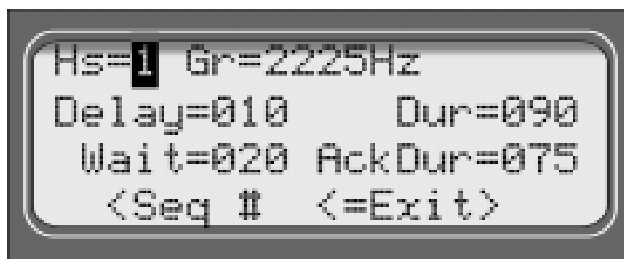



Figure 5-12 Handshake Order Number

4. When the desired order number is flashing press  or .



The display will start flashing the format group field.



### To Change the Format Group:

1. Follow the procedures in Section 5.4.2.

2. Press **1** for handshake sequence menu.

3. Press  until the display flashes on the Format Group field. See Table 5-10 for valid entries.







4. Press the  or  button to change the format group. See Table 6-1 in Section 6 for your communication format.

5. When the desired format group is flashing press  or .









**To Change the Handshake Delay Time:**

This is the duration of time that the receiver will wait before it sends its handshake tone. See Table 5-10 for valid entries.

1. Follow the procedures in Section 5.4.2.
2. Press  for handshake sequence menu.
3. Press  until the display flashes on the Hs delay field.
4. Enter the desired value from the keypad or press the  or  button to change the delay time.
5. When the desired handshake delay time is flashing press  or .







**To Change the Handshake Duration Time:**

The handshake duration is the length of time that the receiver will send a handshake tone. See Table 5-10 for valid entries.

1. Follow the procedures in Section 5.4.2.
2. Press  for handshake sequence menu.
3. Press  until the display flashes on the Hs duration field.
4. Enter the desired value from the keypad or press the  or  button to change the handshake duration time.
5. When the desired handshake duration time is flashing press  or .





### To Change the Maximum Handshake Wait Time:

The wait time is the amount of time the receiver will wait for data from the reporting panel before outputting the next handshake sequence. See Table 5-10 for valid entries.

1. Follow the procedures in Section 5.4.2.
2. Press  for handshake sequence menu.
3. Press  until the display flashes on the Max Wait field.
4. Enter the desired value from the keypad or press the  or  button to change the wait time.
5. When the desired wait time is flashing press  or .

### To Change the Acknowledgment Tone Duration Time:

The acknowledgment tone duration time is the amount of time the receiver will send an acknowledgment tone to the reporting panel. See Table 5-10 for valid entries.

1. Follow the procedures in Section 5.4.2.
2. Press  for handshake sequence menu.
3. Press  until the display flashes on the Ack duration field.
4. Enter the desired value from the keypad or press the  or  button to change the acknowledgment tone duration time.

### 5.4.2.2 Line Options

Line options is used to set the type of phone line, number of ring, ring on/off duration, threshold voltage, and sample time.

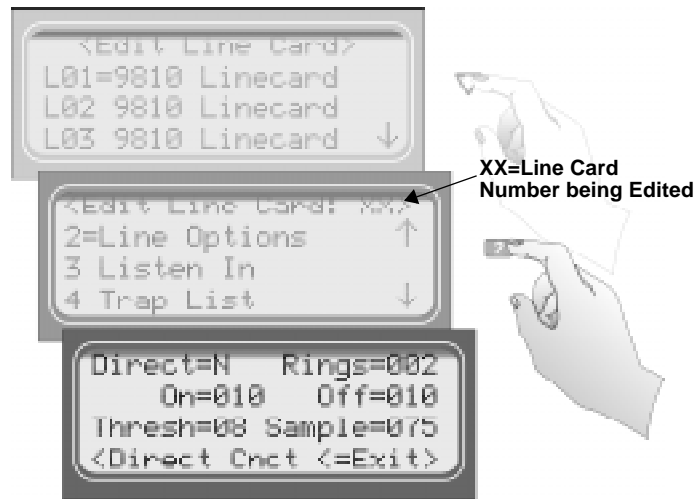









Figure 5-13 Line Options Menu

#### How to Set the Line Card for a Direct Line (Dedicated Line):

1. Follow the procedures in Section 5.4.2.
2. Press **2** for Line Options menu.
3. The display will flash on the `Direct` field.
4. Press the  or  button to between Y for Yes, or N for No.
5. When the desired setting is flashing press  or .

### To Change the Number of Rings Follow These Steps:





This controls the number of rings the receiver needs to see before it will answer the call.

1. Follow the procedures in Section 5.4.2.
2. Press **2** for Line Options menu.
3. The display will flash on the Num Rings field.
4. Enter the desired value from the keypad (0-255) or press the  or  button to change the number of rings before the receiver will answer.
5. When the desired number of rings is flashing press  or .

*Note: If Caller ID (see Section 5.4.2.5) is turned on the number of rings must be set to 2.*







### To Change the Ring On Time:

The “On” field controls the ring on time. The ring on time is the length of time the receiver will listen to a ring prior to recognizing it as a ring.

1. Follow the procedures in Section 5.4.2.
2. Press **2** for Line Options menu.
3. Press  until the display flashes on the On Time field.
4. Enter the desired value from the keypad or press the  or  button to change the ring on time. Values range from 0 to 255 in increments of 50ms (1=50ms, 2=100ms, 3=150ms and so on).
5. When the desired ring on time is flashing press  or .







**To Change the Ring Off Time:**

The “Off” field controls the ring off time. The ring off time is the length of time the receiver will recognize an “Off” ring voltage.

1. Follow the procedures in Section 5.4.2.
2. Press  for Line Options menu.
3. Press  until the display flashes on the Off Time field.
4. Enter the desired value from the keypad or press the  or  button to change the ring off time. Values range from 0 to 255 in increments of 50ms (1=50ms, 2=100ms, 3=150ms and so on).
5. When the desired ring off time is flashing press  or .







**To Change the Ring Threshold Voltage:**

The “Threshold” field controls the phone line low voltage/Line Fault threshold level. If the voltage on the phone line connected to the line card drops below this set threshold level for that line card, the receiver will indicate a Line Fault on that phone line.

1. Follow the procedures in Section 5.4.2.
2. Press  for Line Options menu.
3. Press  until the display flashes on the Threshold field.
4. Enter the desired value from the keypad or press the  or  button to change the Line fault threshold level. Values range from 1 to 15 volts in 2.0 VDC increments (0=line monitor disabled. 1=2.0VDC, 2=4.0VDC, 3=6.0VDC and so on).
5. When the desired line fault threshold is flashing press  or .

### To Change the Phone Line Sample Rate:

The sample time field controls how often the receiver will sample the phone line to verify that it is above the set threshold level of that line card. This is how often the receiver verifies the integrity of the phone line.

1. Follow the procedures in Section 5.4.2.
2. Press  for Line Options menu.
3. Press  until the display flashes on the Sample Time field.
4. Enter the desired value from the keypad or press the  or  button to change the line sample rate. Values range from 0 to 255 in 1 second increments (1=1 second, 2=2 seconds, 3=3 seconds and so on). The receiver will make two to three samples before generating a trouble condition on a faulty line.
5. When the desired sample time is flashing press  or .
6. Press  to exit this menu.

### 5.4.2.3 Listen-In

*Note: See Section 2.3.2 for UL requirement on listen-in.*



The listen in feature is used to perform two-way voice alarm verification between the central station and the alarm installation site.



**Figure 5-14 Listen Mode Menu Display**

#### To Change the Listen Mode:





1. Follow the procedures in Section 5.4.2.
1. Press **3** for the listen in options menu.
2. When the display shows the listen in options menu (see Figure 5-14):

Press the  or  button to change the listen mode setting.

3. When the desired setting is flashing press  .





### To Change the PBX String:

This option only appears if PBX is select as the mode.

1. Follow the procedures in Section 5.4.2.
2. Press  for Listen In options menu.
3. Press  until the display flashes on the <Str> field.
4. Press .
5. Enter the desired numeric value from the keypad or press the  or  button to enter any special characters.

**Table 5-12: Valid Programmable String Characters**

Character	Description
F	Flash hook.
P	Delay 500ms
,	Delay 2 seconds
H	Force a hang up of the line.
@	Detect dial tone.
t	Check to see if the line is busy by looking for a busy tone.
0-9, *, #, A, B, C, D	DTMF digits.





6. Press  to move to the next character.  
or
7. Press  to enter the PBX string.
8. Select Y or N by pressing the the  or  arrows.  
Y = Yes, erase or clear the PBX string. N = No, do not clear the PBX string, save the entered value.

*Note: If Yes is selected the PBX string will be cleared and the “Clear String” option will revert to N (No).*





**To Change the Listen-In Timeout:**

Timeout is the amount of time Listen-in will remain active before timing out.

1. Follow the procedures in Section 5.4.2.
2. Press **3** for Listen In options menu.
3. Press  until the display flashes on the <Timeout> field.
4. Enter the desired value from the keypad or press the  or  button to change the timeout setting. Values range from 0 to 255 in 1 second increments.
5. When the desired value is flashing press .

**To Edit the Listen-In accounts Lists:**

1. Follow the procedures in Section 5.4.2.
2. Press **3** for Listen In options menu.
3. Press  until the display flashes on the <Account List> field.
4. Press .

The Figure 5-15 shows the next display.



**Figure 5-15 Listen In Accounts Menu**

### To Add a Listen In Account

5. Press **1**.

The display briefly shows the number (indicated by XX) of the lowest available listen in account number slot (20 total listen in account numbers). Adding # XX

6. Enter the account number you wish to add to the listen in account list.



7. When the desired account number is flashing press .

**Table 5-13: Account Characters**

Characters	Description
0-9	Numeric entries
A-Z	Alpha entries
*	Alpha-numeric wild card entry. Example: 123* = any account starting with 123.
#	Numeric wild card entry. Example: # = 0 to 9. Example: 12345# = 123450 to 123459.

### To Edit a Listen In Account

8. Press **2**.

9. Press the  or  button until the desired listen in account is highlighted by the equal sign.

10. Press .



11. Enter the revised account number you wish to the account list. See Table 5-13.

12. Press .

*Note: When editing an existing account it must be completely re-entered.*

### To Clear a Listen In Account

13. Press **3**.

14. Press the  or  button until the desired listen in account is highlighted by the equal sign.

15. Press .

The Display will read: < WARNING! >  
Delete Record No

16. Press the  or  button to toggle to Yes.



*Note: Additional presses of the up or down arrow will toggle the choice between “yes” and “No”.*

17. Press  .

#### 5.4.2.4 Trap List

The trap list is used to trap an account that you wish to route to a downloading computer for initial or additional programming.







##### To Add a Trap Account

1. Follow the procedures in Section 5.4.2.
2. Press  for Trap List menu.
3. Press  .





The display briefly shows the number (indicated by XX) of the lowest available trap account number slot (20 total trap account numbers). Adding # XX

4. Enter the account number you wish to add to the trap account list. See Table 5-13.
5. When the desired account number is flashing press  .

##### To Edit a Trap Account

1. Follow the procedures in Section 5.4.2.
2. Press  for Trap Lists menu.
3. Press  .
4. Press the  or  button until the desired trap account is highlighted by the equal sign.
5. Press  .
6. Enter the account number you wish to add to the trap account list. See Table 5-13.
7. Press  .

### To Clear a Trap Account

1. Follow the procedures in Section 5.4.2.
2. Press  for Trap List menu.
3. Press .
4. Press the  or  button until the desired listen in account is highlighted by the equal sign.

5. Press .

The Display will read:   < WARNING! >  
                          Delete Record No

6. Press the  or  button to toggle to Yes.

*Note: Additional presses of the up or down arrow will toggle the choice between “yes” and “No”.*

7. Press .

### 5.4.2.5 Misc. Line Opt.

Some phone lines may use echo suppression, a billing delay feature, or a hunt group. These miscellaneous phone options can be set through this programming menu.





Figure 5-16 Miscellaneous Phone Line Options

#### To Change the Echo Suppress Setting:

If echo suppression is enabled (Y) a 2025Hz signal will be output for two seconds to disable echo suppression equipment. This option should be used only for panels that require a 2225Hz handshake.

1. Follow the procedures in Section 5.4.2.
2. Press **5** for Miscellaneous Line Options menu (see Figure 5-16).

The display Flashes on the Echo Suppress= field.

3. Press the  or  button to change the echo suppress option from Y (Yes) to N (No) or vice versa.

4. When the setting is flashing press .

## How to Set Caller ID

Caller Id information is only sent if the incoming call has no data contained in it.



*Note: If the incoming message contains any data (valid or invalid) no Caller ID information will be sent.*

1. Follow the procedures in Section 5.4.2.

2. Press  for Miscellaneous Line Options menu (see Figure 5-16).

The display Flashes on the Echo Suppress= field.

3. Press  until the display flashes on the Caller ID field.

4. Press the  or  button to change the caller ID option from Y (Yes) to N (No) or vice versa.

5. When the setting is flashing press .



## To Change the Billing Delay Setting:

If billing delay is enabled (Y), a delay of two seconds will be inserted at the beginning of each incoming call.

1. Follow the procedures in Section 5.4.2.





2. Press  for Miscellaneous Line Options menu.

3. Press  until the display flashes on the Billing Delay field.

4. Press the  or  button to toggle the billing delay between “Yes” or “No”.

5. When the desired setting is flashing press .

**To Change the Hunt Group:**

1. Follow the procedures in Section 5.4.2.
2. Press **5** for Miscellaneous Line Options menu.
3. Press  until the display flashes on the HntGrp field.
4. Enter the desired value from the keypad or press the  or  button to change the hunt group number.
5. When the desired hunt group is flashing press .
6. To exit press .

**5.4.2.6 ITI Options Menu**

In this programming location settings particular to an ITI control panel can be set, such as security codes (SCode), date and time setting, and 300 baud negotiation.



**Figure 5-17 ITI Options Menu**

**Table 5-14: ITI Options Menu Items**

ITI Options Menu	Choice		Valid Entry	Comments	
ITI SCode Menu	Default SCode		00000 to 99999	This set the default security code for this line card. Additional security codes can be added to the SCode table (see below).	
	Add Acct/SCode (up to 20 entries)	Enter control panel 5-digit account No.	00000 to 99999	Enter the 5-digit account number of the ITI control panel that the receiver will be looking for on this line card.	
		Set or Clear Security Code.	Clear	Clear or Set	Clear old security code and set to default security code. (See Default SCode above.)
					If set is chosen an additional menu will appear that allows you to enter the security code you wish to set the panel to.
			Security Code	00000 to 99999 (Appears only if Set is previously chosen)	<b>Note:</b> If the security code entered here is not presently in the SCode table (see below), it will automatically be entered once the line card has successfully communicated with that account.
	Edit Acct/SCode	1 to 20	Same as Add Acct/SCode	Edit an account previously programmed into Add Acct/SCode table.	
	Clear Acct/SCode		1 to 20	Remove an account that was previously programmed into Add Acct/SCode table.	
	Add SCode Table (up to 20)		00000 to 99999	Adds a new security code to the security code table.	
Clear SCode Table		1 to 20	Removes an security code from the SCode table.		
Date/Time Flag	Requested			The date and time programmed into an ITI control panel will only be updated by the receiver if the control panel requests it.	
	Always			The date and time programmed into an ITI control panel will be updated by the receiver automatically every time the control panel calls into the receiver.	
ITI 300 Baud	Yes			If enabled, the receiver will attempt to negotiate 300 baud communication with ITI panels that support 300 baud communication. See 5.4.2.5 for programming steps.	
	No				



**ITI SCode Menu:**

Some ITI control panels use one of two types of communication locks (phone lock or a central station lock). On the panels using a central station lock, a security code is required during communication. In this programming location a 5-digit central station lock security code can be set.

1. Follow the procedures in Section 5.4.2.
2. Press **6** for ITI options menu.

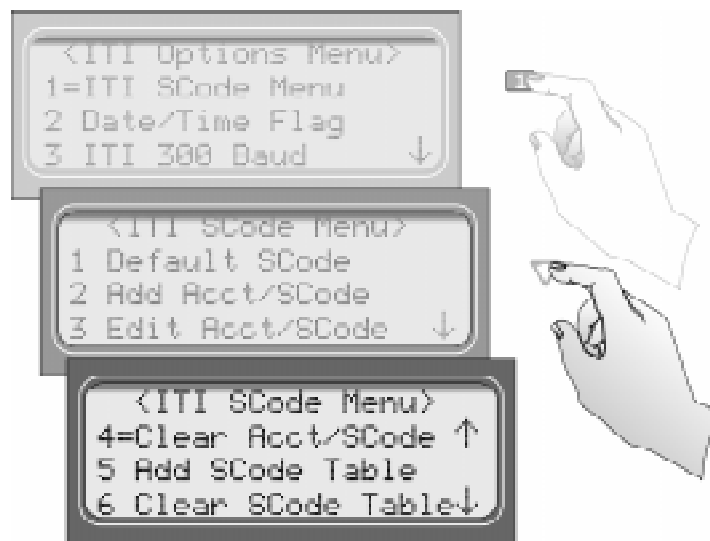

Figure 5-18 ITI SCode Menu

- Press **1** for ITI SCode (security code) menu.

Choose the desired option (refer to Figure 5-18 and Table 5-15).





**Table 5-15: ITI SCode (Security Code) Options**

Choice	Enter	Comments
Default SCode	00000 to 99999	This set the default security code for this line card. Additional security codes can be added to the SCode table (see below).
Add Acct/SCode (up to 20 entries)	Enter control panel 5-digit account No. 00000 to 99999	Enter the 5-digit account number of the ITI control panel that the receiver will be looking for on this line card.
	Clear or Set	Clear old security code and set to default security code. (See Default SCode above.)  If set is chosen an additional menu will appear that allows you to enter the security code you wish to set the panel to.
	Enter Security Code 00000 to 99999 (Appears only if Set is previously chosen)	<b>Note:</b> If the security code entered here is not presently in the SCode table (see below), it will automatically be entered once the line card has successfully communicated with that account.
Edit Acct/SCode	1 to 20 Edit same as Add Acct/SCode	Edit an account previously programmed into Add Acct/SCode table.
Clear Acct/SCode	1 to 20	Remove an account that was previously programmed into Add Acct/SCode table.
Add SCode Table (up to 20)	00000 to 99999	Adds a new security code to the security code table.
Clear Scode Table	1 to 20	Removes an security code from the SCode table.





- Press  .

- Enter the necessary field information (see Table 5-15).

**To Set Date/Time Flag:**

1. Follow the procedures in Section 5.4.2.
2. Press **6** for ITI options menu.
3. Press **2** for date/time flag menu.
4. Press the  or  button to toggle between Requested or Always. See Table 5-14 for description.
5. When the desired setting is flashing press . To exit press .



**To Enable or Disable ITI 300 Baud Negotiation:**





1. Follow the procedures in Section 5.4.2.
2. Press **6** for ITI options menu.
3. Press **3** for ITI options menu.
4. Press the  or  button to toggle between Yes or No. See Table 5-14 for description.
5. When the desired setting is flashing press . To exit press .

**5.4.3 Copy Line Cards**

Copy line cards allows you to either program a line card to defaults or copy the programming of an existing line card.

**5.4.3.1 To Program the Default Settings Into a Line Card**

1. Enter Program Mode (see section 5.1).
2. Press **2** for Line Card menu.
3. Press **3** for copy line card menu.
4. Press the  or  button until the equal sign is adjacent the Use Defaults option. See Table 5-10 for description.











5. Press  .
6. Press the  or  button until the equal sign highlights the desired line card number.
7. Press the  or  button to toggle between Y (yes) or N (no). Yes means you wish to program this line card back to default.



When all the line card numbers (of the line card you wish to program to factory defaults) are chosen.

8. Press  .

**Warning:** This cannot be undone.

### 5.4.3.2 Copy the Programming of an Existing Line Card to Another

1. Enter Program Mode (see section 5.1).
2. Press  for Line Card menu.
3. Press  for copy line card menu.
4. Press the  or  button until the equal sign is adjacent the Copy Existing option. See Table 5-10 for description.
5. Press  .
6. Press the  or  button until the equal sign highlights the desired Source line card number.
7. Press  .
8. Press the  or  button until the equal sign highlights the desired Target line card number.

9. Press the  or  button to toggle between Y (yes) or N (no). Yes means you wish to program this line card with the programming of the line card chosen as the source.
10. Repeat steps 8 & 9 until all the line card numbers (of the line card you wish to program to factory defaults) are chosen.
11. Press .

**Warning:** This cannot be undone.

#### 5.4.4 Clear Line Card

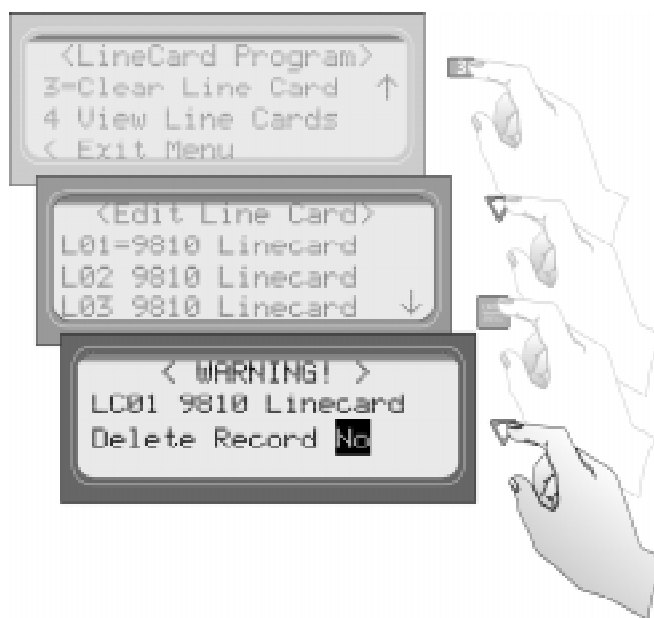





Figure 5-19 Visual Steps to Clear a Line Card From the Receiver

#### To Clear or Delete a Line Card Form the Receiver Follow These Steps:

1. Follow the procedures in Section 5.4.2.
2. Press  to clear a line card.
3. When display shows the list of line cards (see Figure 5-19) press the  until the desired line card is highlighted with an equal sign.
4. Press .

The display will read

```
<Warning!>
LC01 9810 Linecard
Delete Record No
```

5. Press the  until Yes is flashing.

6. Press .

7. To exit press .

## 5.4.5 View Line Cards

To view all the line cards in the receiver follow these steps:

1. Follow the procedures in Section 5.4.2.

2. Press  to view line cards.

3. When display shows the list of line cards (see Figure 5-19) press the  to scroll through the list of line cards.

4. To exit press .

## 5.5 User List

User List is used to program and store the information on the various installers and operators who will operate and maintain the receiver. Through this program menu item you can add, edit or clear (delete) an operator/installer (up to 40 users). The user is identified by name, then assigned a PIN (personal identification number) and a profile.

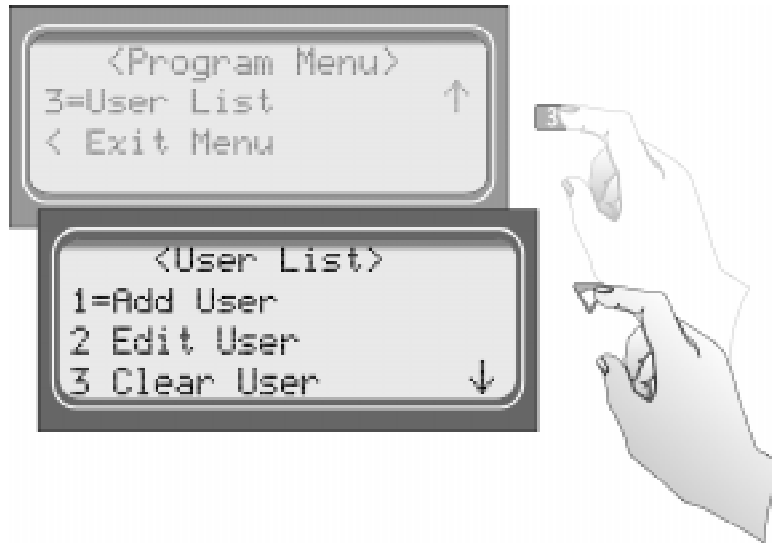

**Figure 5-20 User List Menu Items**

Table 5-16 lists the available choices under User List and provides a matrix of choices.

**Table 5-16: User List Menu Items and Steps**

Choice	Step 1	Step 2	Step 3	Comments
Add User	Enter user name: 1. Use the up or down arrow to move through characters. 2. Press the right arrow to move to next character slot. 3. Press enter key to move to next step.	Enter PIN code: 4 digits minimum 9 digits maximum	Choose profile level: Operator or Installer	Add user is used to add a new user to the system and enter the user's PIN and profile information.
Edit User	When "Choose User" list appears: 1. Press the down arrow key until the desired user is highlighted with the equal sign. 2. Press enter to move to next step.	Repeat Steps 1-3 under Add User.		Edit user is used to change an existing users profile.
Clear User	When "Choose User" list appears: 1. Press the down arrow key until the desired user is highlighted with the equal sign. 2. Press enter to move to clear user from profile list.			Clear user is used to delete a user from the receiver's memory.

## 5.5.1 Adding a User

Use the following steps to add a user to the system:

1. Log on to the receiver. (See Section 4.4.4 for log on procedure.)

2. Press  button.

3. Press  for program menu.



The display will briefly display Initializing

Please wait . . .

4. Press  to choose User List.

5. Press  to add a user.

The user number to be programmed will appear in the display for one second. This user number will always be the lowest available user number.

6. Press the  or  arrow buttons to move through the available characters.

**Table 5-17: Available Characters**

Characters	Comments
Space, 0-9, !, -, _, ., , , &, *, #	The word "Space" indicates that a physical space would be inserted if this character were chosen.
A-Z	Upper case alphabetical characters
a-z	Lower case alphabetical characters

There are 16 characters available for each user name.

*Note: If no characters are entered in the name field, the user name will default to "User #XX". XX = the number location of the user being programmed. For example, if user 12 location is being programmed and no name characters are entered in the name field, then that user will be named User #12.*

When the desired character is flashing in the display:

7. Press the  right arrow key.
8. Repeat steps 6 and 7 until the user's name is complete.

9. Press  .





10. Enter the desired PIN code for the user.

A minimum of 4 character and a maximum of 9 characters.

11. Press  .

The display will flash Operator.

12. Press the  or  arrow buttons to toggle between Installer and Operator.

13. When the desired profile level is flashing press  .

## 5.5.2 Editing a User

Use the following steps to edit an existing user:

1. Log on to the receiver. (See Section 4.4.4 for log on procedure.)

2. Press  button.

3. Press  for program menu.



the display will briefly display Initializing

Please wait . . .

4. Press  to choose user list.

5. Press  to edit a user.

A list of all the users will appear starting with the lowest user number.

6. Press the  or  arrow buttons to move through the user list.

7. When the equal sign highlights the user you wish to edit press  .

8. If you **do not** want the user name changed, press  .

Or

To change the user name, press the  or  arrow buttons to move through the available characters. (See Table 5-17 for list of available characters.) When the name



change is complete press  .

9. If you **do not** want the PIN code changed, press  .

Or

To change the PIN code enter the desired code (4 to 9 digits in length), then press  .

The display will flash the current profile level.

10. Press the  or  arrow buttons to toggle between Installer and Operator.

11. When the desired profile level is flashing press  .

### 5.5.3 Clearing a User Out of the Receiver

Use the following steps to clear or delete a user from the system:

1. Log on to the receiver. (See Section 4.4.4 for log on procedure.)

2. Press  button.

3. Press **7** for program menu.



The display will briefly display Initializing

Please wait . . .

4. Press **3** to choose user list.

5. Press **3** to clear (delete) a user.

A list of all the users will appear starting with the lowest user number.

6. Press the  or  arrow buttons to move through the user list.

7. When the equal sign highlights the user you wish to clear press  .

The display shows < WARNING ! >

Delete Record No

8. Press the  or  arrow button to toggle the flashing display to Yes.

9. Press  .



## Section 6

# Compatible Reporting Formats

This section lists all the reporting formats that are compatible with the 9800 receiver. Table 6-1 shows the formats that the 9800 receiver can decode, handshake frequency format group which accommodates that format (see Section 5.4 for line card programming). Each line card can decode every format listed below, however, a line card can be programmed to prioritize the handshake order in which that line card will communicate.

### 6.1 Formats By Communication Group.

Table 6-1 shows which formats fit under the general communication groups and the corresponding handshake frequency.

**Table 6-1: Formats compatible with the 9800**

Communication Group	Format Name	Description	Handshake Format Group
Tone Burst	SK 4+2	Sends a 4-digit account and a 2-digit alarm code up to four rounds.	1400 Hz
	Sescoa 3+1/Franklin 3+1	Sends a 3-digit account and a 1-digit alarm code up to four rounds in a tone burst format. Each digit can be programmed from (0-9). Because there is no standard, this format reports in codes only.	2300 Hz
	Radionics 3+1 Checksum	Sends a 3-digit account and a 1-digit alarm code and a checksum.	1400 or 2300 Hz
	SK 3+1/3+1 Extended	Sends a 3-digit account and a 1-digit alarm code up to four rounds (10-40pps). Each block of data (2 rounds). If a second block of data is sent, it will contain the extended information. The account number cannot have repetitive digits (333, 888, etc.).	1400 or 2300 Hz
	4+1/4+1 Extended	Sends a 4-digit account code and a 1-digit alarm code up to four rounds in a pulse format (10-40pps).	4/1 1400 or 4/1 2300 Hz
	Pulse 4+2	sends a 4-digit account code and a 2-digit alarm code.	1400 or 2300 Hz
DTMF	Ademco Contact ID	Dual Tone Multiple Frequency. The data is decoded into English account information.	1400_2300 Hz
	Ademco Super Fast,	Sends a 4-digit account code and a 2-digit alarm code up to 9 events per call.	
	Acron Touch Tone	Sends a 4-digit account code and a 1-digit alarm code. Will send a maximum of 8 events per call.	
	Ademco Express	Sends a 4-digit account code and a 2-digit alarm code with a checksum.	
	DTMF 4+2	Sends a 4-digit account code and a 2-digit alarm code with a checksum.	1400 or 2300 Hz
FBI 4+3+1	Sends a 4-digit account code, a 3-digit zone code and a 1-digit event code.		

**Table 6-1: Formats compatible with the 9800**

Communication Group	Format Name	Description	Handshake Format Group
FSK	*SX-III, SX-IVA	Sends a 5-digit account code in a Bell 103 format with checksum. The data is decoded into English account information.	2225 Hz
	*SX-IVB		
	ITI SX-V		
	*ITI Commander		
	*ITI RF Commander, Harbor Guard		
	ITI Commander 2000, LifeGard		
	ITI CareTaker+, SecurityPro 4000		
	*ITI MeterMinder		
	*ITI FonSafe, PhoneWatch		
	ITI UltraGard		
	SIA DCS (Digital Communication Standard)	The data is decoded into English account information.	
	SIA 2000 (pending approval)	The data is decoded into English account information.	
	BFSK	Sends a 3-digit account and a 1-digit alarm code, similar to 3+1 Extended format except the data is decoded into English account information.	1400 or 2300 Hz
SK FSK, FSK 0, FSK 80	Sends a 4-digit account code and a 1 byte (8 bit) of zone status information. Sends a 2225 Hz mark Frequency and a 2025 Hz space frequency from the dialer. Repeats the data message for verification.	1400 or 2300 Hz	
SKFSK I, FSK I, FSK 81	Sends a 4-digit account code and a 2-digit alarm code. Sends a 2225 Hz mark Frequency and a 2025 Hz space frequency from the dialer. verification is done with check xor and checksum. 1 to 8 events per call.	1400 or 2300 Hz	
FSK II, FSK 86	Sends a 6-digit account code with a 2-digit alarm type and 2-digit zone number. Sends a check xor and checksum. 1 to 8 events per call.	1400 Hz	

\* Not compatible with the 9800 receiver at this time.

## 6.2 Format Numbers Used In Printer Output

In a printed report the format used by a calling panels is listed as a number, that number represents a particular format. Table 6-2 lists these numbers along with the corresponding format.

**Table 6-2: Formats By Report Number**

<b>Format Number</b>	<b>Fomat Type</b>
0	No Response
3	SIA 2000
4	SIA DCS
9	ITI
10	ITI SX-III or SX-IVA
11	ITI Pin Piont 128
12	ITI RF Commander
13	ITI Protection One/UltraGard
14	ITI CareTaker Plus
15	ITI SX-V
16	ITI Commander 2000
17	ITI Harbor Guard
18	ITI Simon
19	ITI Vector
20	ITI Hardwire Commander
21	ITI SX-V Special/Rollins
22	ITI Marsden
23	ITI Network Security
24	ITI Nutone
25	ITI SX-IVB
30	3/1 Pulse Tone
31	3/1 Franklin/Sescoa
32	3/1 Ademco/SK
33	3/1 Extended
35	4/1 Pulse Tone
36	4/1 Franklin/Sescoa
37	4/1 Ademco/SK

**Table 6-2: Formats By Report Number**

<b>Format Number</b>	<b>Fomat Type</b>
38	4/1 Extended
40	Unknown Pulse
41	4/2 Ademco/SK
43	4/2 Extended
46	3/1 Radionics
47	3/1 Radionics with checksum
48	4/2 Radionics with checksum
50	Ademco Contact ID
51	Ademco Touch Tone
52	Acron Touch Tone 3-digit account
53	Westec Touch Tone
54	Ademco Express
55	SIA D1
56	SIA D1 with checksum
57	Ademco DTMF 4/2 with checksum
58	Ademco DTMF 4/1 with checksum
59	Acron Touch Tone 4 digit account.
60	BFSK
61	FSK0/FSK80
62	FSK1/FSK81
63	FSK2/FSK86
64	FBI 4/3/1 with checksum
65	FBI 4/3/1



# Section 7

## Troubleshooting

This section contains a list of possible error messages and a troubleshooting process for each.

### 7.1 Error Messages

Table 7-1 lists the error messages that are displayed on the LCD of the receiver as well as the message sent to the printer. There are two types of error messages that are displayed and printed, line card communication errors, and system event errors. Line card communication errors relate specifically to how the receiver communicated to an incoming call. System event errors relate specifically to the system and the performance of its peripheral devices such as the automation software, printers, etc. In Table 7-1, heading “LC Error” indicates that the error message was a line card communication error and “SYS Error” indicates any system event related error messages.

**Table 7-1: Error Messages**

LC Error	Sys Error	LCD Messages	Printer Message	Description	What to Do
✓		No Data Received	No Data Received	On an incoming call no data was sent to the receiver after the receiver gave its handshake tones.	Usually a wrong number.
✓		0 Length Block	0 Length Blk	One of the message blocks received contained no data.	Possibly a call with caller ID information but no data from a control panel.
✓		No Ack	No Ack	Receiver was unable to acknowledge the call.	Check the line card setup and retest the panel.
✓		Time Out	Time Out	The incoming call timed out and the phone line was released.	1. Retest Panel.
✓		Corrupted Data	Corrupted Data	Bad or corrupted data was sent to the receiver.	2. Replace panel.
✓		Illegal Specifier	Illegal Specifier	An error occurred in the look-up table for this call message.	3. Replace line card.
✓		Undefined Event	Undefined Event	The panel communicating to the receiver sent an event code that the receiver does not recognize.	Call Technical Support.
✓		Unsupported Event	Unsupported Event	The panel communicating to the receiver sent an event code that the receiver recognized but does not support.	
✓		Unsupported Format	Unsupported Fmt	The calling panel communicated in a format not supported by the receiver.	Program the panel to a different reporting format.

**Table 7-1: Error Messages**

LC Error	Sys Error	LCD Messages	Printer Message	Description	What to Do
✓		Communication Error	Communication Error, Panel Requested Re-send	There was a communication error between the panel and the receiver and the receiver asked the panel to re-send the message.	If it continues test the panel.
✓		Possible Incomplete	Possible Incomplete Call	The receiver missed information in the call sequence.	Retest the panel.
	✓	System Power Up	System Power Up	Indicated that the receiver powered up.	
	✓	Expander Trouble	Expander Trouble	Trouble with a device connected to the SBUS.	Check the connection of that device on the SBUS. If connection OK replace SBUS device (line cards and touchpads).
	✓	Expander Trbl Rst	Expander Trouble Restore	The trouble condition of a SBUS device was corrected.	
	✓	AC Trouble	AC Trouble	AC power failure.	Check AC outlet and AC power cord.
	✓	AC Trouble Rst	AC Trouble Restore	AC power was restored.	
	✓	Battery Low Restore	Battery Low Restore	The backup battery power supply trouble has been corrected.	Restores at 12VDC after a low battery condition.
	✓	Battery Low	Battery Low	The backup battery is checked continually every second. This message would be displayed if the backup battery were set to "Battery Bkp". See Section 5.3.4. Indicates a low battery when the voltage drops to 10.2 VDC or lower.	Check battery cables. If they are OK replace backup battery.
	✓	Local Program Begin	Local Program Begin User #	This message indicates the time a system "installer" entered program mode.	
	✓	Local Program End	Local Program End User #	This message indicates the time a system "installer" exited program mode.	
	✓	Local Program Fail	Local Program Fail User #	The receiver will stay in program mode for 15 minutes without any activity, then it will time out and go back to normal mode. This message indicates that an installer entered programming and did not exit programming before it timed out.	
	✓	Listen-in End	Listen-in End	A listen-in session completed	
	✓	Listen-in Begin	Listen-in Begin	A listen-in session started.	
	✓	System Date Changed	System Date Changed User #	An installer changed the system date.	
	✓	System Time Changed	System Time Changed User #	An installer changed the system time.	

Table 7-1: Error Messages

LC Error	Sys Error	LCD Messages	Printer Message	Description	What to Do
	✓	Msg Queue Full	Message Queue Full	Messages can be sent to automation computer, a printer or can be manually acknowledged. If one or more of these devices does not respond to messages being sent or manually acknowledged, the message queue will fill up. When the message queue is full the receiver will no longer accept incoming calls.	Verify that messages are acknowledged to any printers, automation software, and while in manual mode.
	✓	Msg Queue Full restore	Message Queue Full restore	Indicates that the message queue full error has been corrected.	
	✓	Main Computer Trbl	Main Computer Trouble	A communication problem exists between the automation software and the receiver.	Check cable connections. Verify that the port is configured properly.
	✓	Main Computer Rst	Main Computer Restore	The communication error between the receiver and the automation software has been corrected.	
	✓	Bkup Computer Trbl	Bkup Computer Trouble	A communication problem exists between the backup automation software and the receiver.	Check cable connections. Verify that the port is configured properly.
	✓	Bkup Computer Rst	Bkup Computer Restore	The communication error between the receiver and the backup automation software has been corrected.	
	✓	Main Prn Off Trbl	Main Printer Off Line	The port programmed as the primary printer port is off line.	Check cable connections. Verify that the port is configured properly. Check power to printer.
	✓	Main Prn Paper Out	Main Printer Paper Out	The port programmed as the primary printer port is out of paper.	Replace paper in printer.
	✓	Main Prn Restore	Main Printer Restore	The error on the primary printer has been corrected.	
	✓	Bkup Prn Off Trbl	Bkup Printer Off Line	The port programmed as the backup printer port is off line.	Check cable connections. Verify that the port is configured properly. Check power to printer.
	✓	Bkup Prn Paper Out	Bkup Printer Paper Out	The port programmed as the backup printer port is out of paper.	Replace paper in printer.
	✓	Bkup Prn Restore	Bkup Printer Restore	The error on the backup printer has been corrected.	
	✓	DC Input Low Rst	DC Input Low Restore	The backup DC power supply trouble has been corrected.	Restores at 12VDC after a low battery condition.

**Table 7-1: Error Messages**

LC Error	Sys Error	LCD Messages	Printer Message	Description	What to Do
	✓	DC Input Low	DC Input Low	The backup battery is checked continually every second. This message would be displayed if the backup battery setting were set to "DC Bkp". See Section 5.3.4. Indicates a low when the voltage drops to 10.2 VDC or lower.	Check the connection to the DC power supply. Verify the output from DC power supply.
	✓	Msg Que > Warning	Message Queue Warning	When the message queue reaches the programmed level mark, this message is given as a pre-warning to "Message Queue Full". See Section 5.3.5.1 to program the % level at which the receiver will indicate the warning.	Verify that messages are acknowledged to any printers, automation software, and while in manual mode.
	✓	Msg Que < Warning	Message Queue Warning Restore	This message is given when the message queue drops below the programmed level after a message queue warning indication has displayed. See Section 5.3.5.2 to program the % level.	
	✓	LC Run in ROM	Linecard Running ROM Code	The line card is not running the application code.	Replace the line card.
	✓	Line Fault	Line Fault	The phone line voltage has dropped below the threshold voltage as programmed. (See Section 5.4.2.2.)	Check phone line outlet and phone cord.
	✓	Line Fault Restore	Line Fault Restore	Phone line voltage has been restored to normal parameters.	
	✓	Line Card Deleted	Line Card Record Deleted	A line card has been deleted.	
	✓	Line Card Added	Line Card Record Added	A line card has been added.	
	✓	User Log In	User Log In: User #	A user has logged on to the receiver.	
	✓	User Log Out	User Log Out: User #	A user has logged off of the receiver.	

## 7.2 Troubleshooting Process

---

Before you call Technical Support you may be able to solve the problem yourself by following these procedures.

1. Verify that a problem exists.
2. Check Fault Status.

This can be done by pressing the



. If the system fault LED in on the display will read:



Press the down arrow to view fault messages.

3. Check the manual for suggestions or solutions.
4. Check connections.
5. Isolate the problem. Remove other devices that may be interfering.
6. Try swapping devices to isolate the problem.
7. Try to replace the problematic device.
8. Document the failures and the steps used to resolve them.

## 7.2.1 Removing the Power Supply/Mother Board Assembly

Once Silent Knight Technical Support has determined that a problem exists with either the main power supply or the mother board, use the following procedure to remove the assembly and return it to Silent Knight for repair.

1. Turn the main power switch to the “off” position. (See Figure 3-2.)
2. Disconnect AC power Cable.
3. Disconnect the backup battery. (See Figure 3-14.)
4. Remove the front plate by unscrewing the front plate retaining screws. (See Figure 3-1 for locations of front plate retaining screws.)
5. On the back of the receiver remove the four screws that hold the mother board/power supply assembly to the chassis. (See Figure 7-1 for screw locations.)

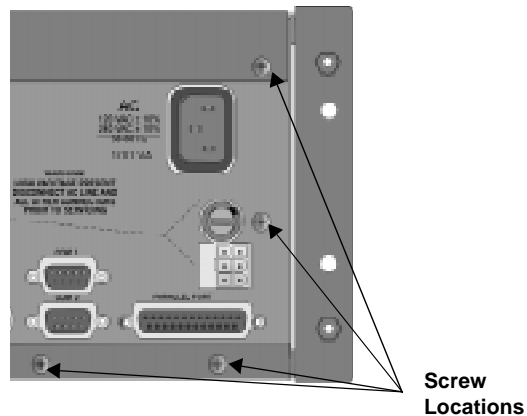

**Figure 7-1 Mother Board/Power Supply Assembly retaining Screw Locations**

6. From the front of the receiver pull the mother board/power supply assembly out.

## 7.2.2 Replacing the Mother Board/Power Supply Assembly

1. Remove the front plate by unscrewing the front plate retaining screws. (See Figure 3-1 for locations of front plate retaining screws.)
2. From the front side of the receiver slide the replacement mother board/power supply assembly back into the receiver chassis.
3. On the back of the receiver replace the four screws that hold the mother board/power supply assembly in place. (See Figure 7-1.)
4. Make sure that the power switch is in the “off” position. (See Figure 3-12.)
5. Reconnect the AC power cable.

*Note: Make sure to plug the AC power cable into a grounded outlet. (See Section 3.9.2 for procedure on how to verify earth ground.)*

6. Reconnect the back-up battery. (See Figure 3-14.)
7. Turn the main power switch to the “on” position. (See Figure 3-12.)
8. Replace the front plate by screwing in the front plate retaining screws. (See Figure 3-1.)

## 7.3 Safe Mode

---

Safe mode can be used to reset User #01 access code back to default of 9800 regardless of its present setting.

For Example, if the code for the installer (User #01) is lost and additional programming is required the receiver can be restarted in safe mode to return User #01 to an access code of 9800.



Follow these steps to initiate Safe Mode and default User code #01:

1. Follow the steps in Section 4.6.7 to restart the receiver.

*Note: All messages must be acknowledged before a system restart procedure can be performed. If all messages are not acknowledged, cycle the receiver’s power to restart the system. If the power is cycled all unacknowledged messages will be lost.*

2. When the display Shows 

```
Model 9800 Receiver
Silent Knight
```

3. Press the  button, then the  button.

The display will read 

```
Safe Mode Activated
```

4. Press .

5. Enter the default Installer code or 9800.

## **7.4 Updating the Receiver Software**

---

Silent Knight will continue to test reporting formats with the 9800 receiver. As additional reporting formats become available it may be necessary to update your receiver. This can be done from your own PC, using a null modem cable (see Figure 3-15 and Figure 3-16). Any software upgrades will be sent to you on a 3.5 inch floppy disk and will come with downloading instructions.



---

## Section 8

# Automation Communication Formats

---

---

### 8.1 Introduction

---

The receiver supports several automation communication formats which are used to communicate with an automation computer. The supported formats are Silent Knight's proprietary protocol and the SIA (Security Industry Association) CIS (Computer Interface Standard). The Silent Knight protocol is described in Section 8.2. The SIA protocol is described in Section 8.3.

#### 8.1.1 Conventions Observed In This Section

This manual uses the term "automation computer" to refer to a computer that receives data from the 9800 and interprets it through software that automates the central station.

For the purposes of this manual, a "message" is any data the 9800 is passing to an automation computer. We'll reserve the term message for discussions of the string as a whole.

The term "call from panel" will refer to the complete data stream from a panel to the 9800. The term "event data" will refer to the actual data, (that is, alarms, troubles, and so on), that are part of a call from a panel. (In the SIA protocol, the event data is the part of the message that is contained within brackets [ ].)

The term "system message" will refer to messages the 9800 sends to an automation computer about its internal status.

Another convention of this manual is to use hexadecimal values to refer to data (rather than the ASCII characters that represent the values). Hexadecimal numbers will be represented with a \$ symbol in front of them as in "\$0A".

## 8.2 Silent Knight 9000 Protocol

The following sections describe the Silent Knight computer protocol.

### 8.2.1 Data String Description And Special Characters

Table 8-1: Data String Description

Data Element	Byte(s) Occupied	Description
Identifier	1	The first byte of a message is the identifier. This byte is always \$01 or \$27. \$01 = a system message \$27 = a call from a panel
Date	2-7	The next 6 bytes are the date in MMDDYY format, where each byte contains the ASCII code for the digits 0-9.
Separator	8	The byte after the date is a separator. It will always be \$22.
Time	9-12	The time, in the 24-hour military format, at which the 9800 receives the message occupies bytes 9-12. Each byte contains the ASCII code for the digits 0-9.
Separator	13	The separator \$22 occupies byte 13. The actual call or message data follows this byte.
Format number	14	In a call, byte 14 is the format number, which indicates the format of the line card the call was received in.
Line card number	15	Byte 15 is the line card hunt group number. In some cases you may need to decode the hunt group number. If the hunt group is set to 00 then the number sent in byte 15 is equal to the line card number. (See section 5.4.2.5 for more information.)
Separator	16	Byte 16 is a separator that precedes the actual call or message data. The data will be \$05.
Account #	Variable, beginning at position 17.	Can be 1-8 bytes long. ASCII codes for the digits 0-9 and characters A-Z are acceptable data.
Separator	Variable	The separator \$22 separates the account number from the first event.
Event Data (Alarms and System Messages)	Variable	Alarms can be up to 11 characters. Multiple alarms are separated by \$22 (ASCII code for the double quotation mark). System messages, (indicated when the first byte of the message is \$01), are always sent separately. For example, if two line cards have a problem at the same time, the 9800 will send one message for each line card.
Validation Byte (V-Byte)	1 byte. Follows event data.	Error-check byte. (See section 8.2.6 for more information.)
End of Message Indicator (carriage return)	1 byte. Last byte in call.	This byte is always \$0D and indicates the end of the message.

**Table 8-2: Special Characters Used in the Protocol**

Hex Value	Meaning
\$27	If this character is the first byte in a string, the data that follows is an actual call from a subscriber (rather than a system message).
\$01	If this character is the first byte in a string, the data that follows is a system message (rather than a call from a panel).
\$22	Separator. Separates the date from the time; separates the time from the data that follows; separates multiple events occurring in the same message.
\$05	Separates header information from account # in messages from subscribers.
\$23	Bad data. This marks a block of questionable data.
\$21	Bad data mixed with good data in the same call. This marks a block of good data that follows a block of questionable data.
\$2C	Long call; more data to come for this call in next block.
\$0D	Indicates end of message.
\$2A	Listen in begins.

## 8.2.2 Calls From Panels

The basic format of a message is shown in the example below. For a complete description of each data element, see Table 8-1.

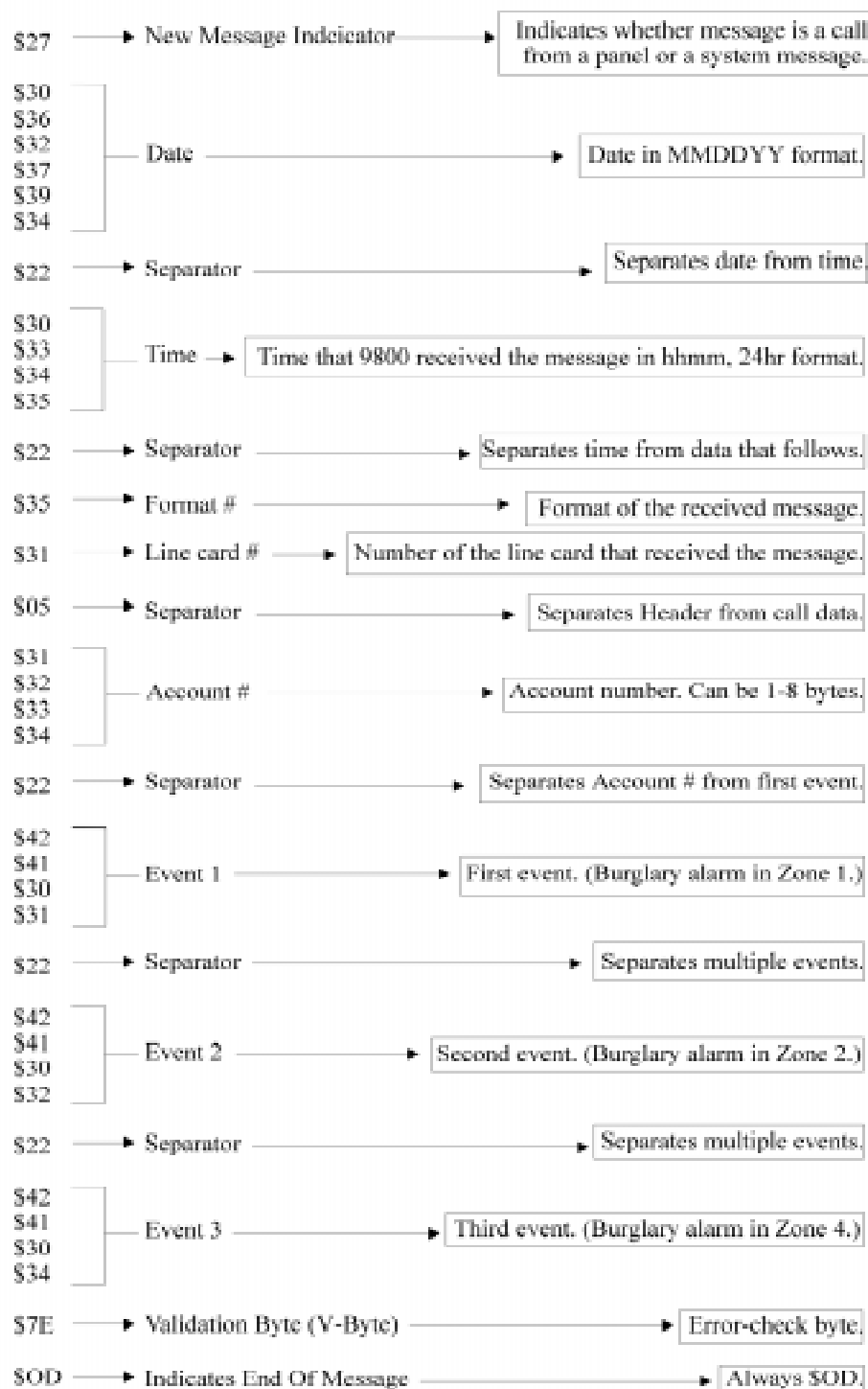
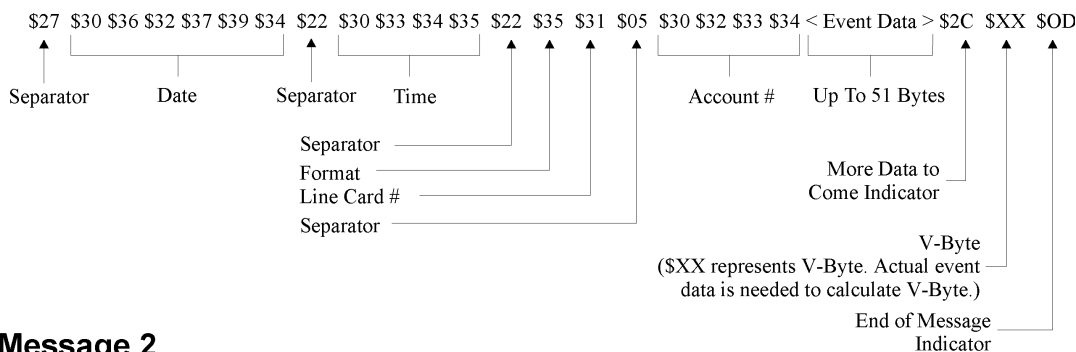

Figure 8-1 Example Message

## 8.2.3 Long Calls

The 9800 can send up to 70 bytes per message to an automation computer. When event data is more than 70 bytes, the 9800 breaks up the data into 70-byte chunks ending in a separator \$2C, a V-Byte, and the end of message indicator \$0D.

### Message 1



### Message 2

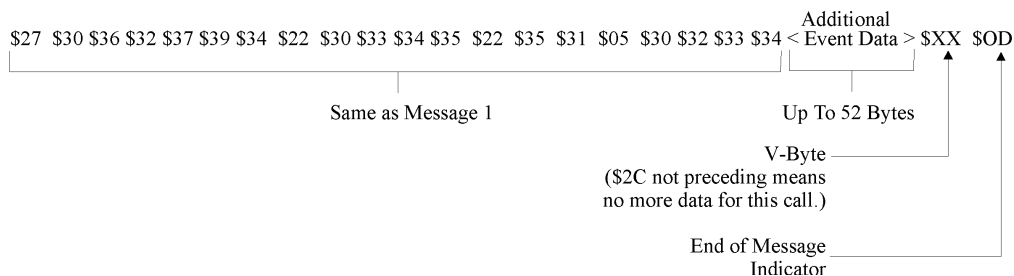

Figure 8-2 Long Event Data

## 8.2.4 Bad Data

When the 9800 receives data it cannot interpret, it precedes the data with \$23. The 9800 accepts 20 characters of bad data. This allows operators to determine, if possible, the account number of the panel sending the bad data for troubleshooting purposes. Causes for bad data include: Noise on the telephone line and non-matching first and second rounds of data.

A single message could include more than one string of bad data, indicating, for example, that the first and second rounds of data did not match each other.

## 8.2.5 Good Data with Bad Data

Good data can be mixed with bad data in one call. \$21 indicates good data after bad. Good data always starts with an account number.

*Note: That this would be the case even if the account number had already been passed before the bad data occurred.*

## 8.2.6 Validation Byte (V-Byte)

The V-Byte always precedes the end of message character. Each data string has this byte as the second to the last byte. The V-Byte is the only error-checking of data the SK 9000 protocol performs. The V-Byte calculation is shown below. The result of the calculation should equal the transmitted V-Byte value.

1. Set the V-Byte comparison byte to zero.
2. Add the first (or next) byte of the message to the V-Byte comparison byte.
3. Clear bit 7 of the V-Byte comparison byte.
4. Set bit 6 of the V-Byte comparison byte.
5. Repeat steps 2, 3, and 4 until the last byte of event data (that is, up to and including the byte preceding the V-Byte). The range of the V-Byte is \$40 to \$7F.

## 8.2.7 System Messages

The character \$01 at the beginning of a data string indicates that the 9800 is reporting its internal status. A sample system message is shown in Figure 8-3. Table 8-3 lists the possible system messages and what format the data can take.

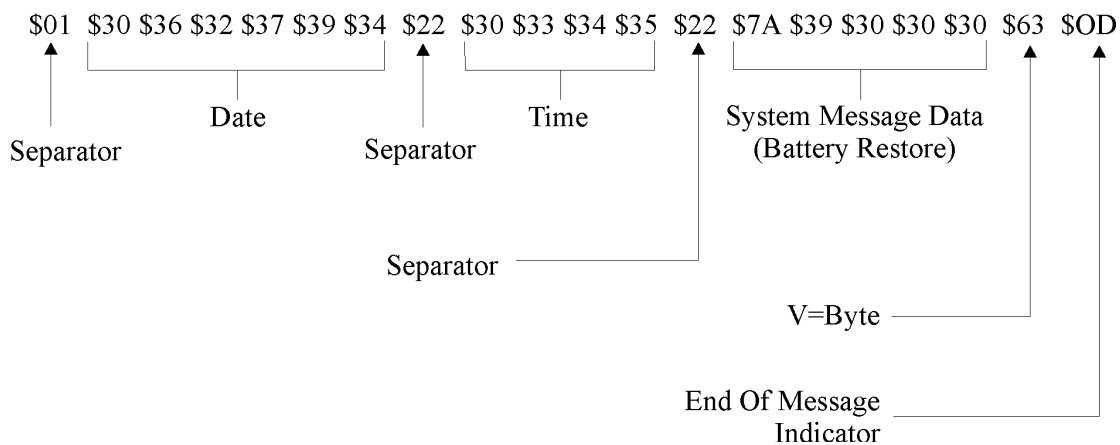

Figure 8-3 System Message

Table 8-3 lists the system messages. Some system messages are one byte. Other messages are always sent with other information, such as the line card number. All system messages are sent separately. For example, if two line cards have a problem at the same time, the 9800 will send one message for each line card. System messages are always followed by the V-Byte and a carriage return (\$0D).

**Table 8-3: System Messages**

SYSTEM MESSAGE	MEANING (PRINTED MESSAGE)
\$77	AC LOST
\$78	AC RESTORE
\$7B	COMPUTER TROUBLE
\$7D	COMPUTER RESTORE
\$70 + 2 bytes for line card number	LINE CARD TROUBLE
\$72 + 2 bytes for line card number	LINE CARD TRBL RSTR
\$71 + 2 bytes for line card number	PHONE LINE TROUBLE
\$73 + 2 bytes for line card number	PHONE LINE RESTORE
\$79 + 4 bytes indicating model 9800. (See Note below.)	BATTERY TROUBLE 9800
\$7A + 4 bytes indicating model 9800.	BATTERY RESTORE 9800
\$7F + 2 bytes indicating the <i>number</i> of the log on code (not the code itself).	LOG ON OPERATOR
\$7E + 2 bytes indicating the <i>number</i> of the log off code (not the code itself).	LOG OFF OPERATOR

*Note: The 4 bytes are the ASCII coded values for the model numbers "9800". For example, "\$79 \$39 \$38 \$30 \$30" means "battery trouble with model 9800".*

## 8.2.8 Communication from a Computer to the 9800

### 8.2.8.1 ACKing And NACKing Data

The computer must respond to messages sent by the 9800 with an ACK or NACK.

An ACK (\$06) is sent when the computer's V-Byte calculation agrees with the V-Byte value sent in the message and the general format of the message looks correct (for example, the last byte was \$0D).

A NACK (\$15) is sent whenever the computer suspects an error in the transmission of the message. The computer must respond within one timeout period of receiving the last byte of a message. (See *Ack Time (Acknowledge Time)* on page 5-24)

The 9800 ignores any other communication from the computer when it is awaiting ACKing or NACKing.

Generally, after two NACKs or two timeout periods of no response from the computer, the

9800 generates a “computer trouble” message.

- If the computer ACKs the data, the 9800 will send any additional data in its buffer.
- If the computer NACKs the data, the 9800 will immediately re-send the data.
- If the computer NACKs a second time, the 9800 will generate a computer trouble message.
- If the computer does not respond the second time the 9800 sends the data, the 9800 will generate a computer trouble message.
- If a backup automation device (printer or secondary automation system) is configured, the unacknowledged message will be sent to the device.

### **8.2.8.2 Link Test**

The automation computer may send a Link Test request to the 9800 receiver to verify the communication link between the receiver and the automation computer. the 9800 receiver will respond to each Link Test (\$00) request with a NACK.



## 8.3 SIA CIS (Computer Interface Standard)

The receivers CIS automation configuration follows the standards set forth in the SIA Computer Interface Standard. This section of the manual provides an overview of Silent Knight's implementation of the CIS standard.

For more information about SIA standards, consult the publications, *Computer Interface Standard, June 1990* and *Digital Communication Standard, February 1993 Revision*. (Both documents are published by and available from the Security Industry Association.)

### 8.3.1 Data String Description And Special Characters

**Table 8-4: Data String Description**

Data Element	Byte Positions Occupied	Data Description
Identifier	1	\$0A indicates the beginning of a new message.
CRC (includes total length of message)	2-7	Bytes 2-7 are the cyclic redundancy check and the length of the entire message. (If you need to know how the CRC is calculated, refer to the publication, <i>Computer Interface Standard, June 1990 Revision</i> , published by and available from the Security Industry Association.)
Separator	8	\$09 separates the CRC from the next field which is the sequence number.
Sequence number	9-12	Four bytes. The sequence number of the message. Valid numbers are 0001-9999. Sequence numbers repeat after 9999. <b>Note:</b> A sequence # of "0000" is used for link test messages.
Receiver ID number	13-14	Two bytes indicating the ID number of the receiver that is sending the message. Valid numbers are 01-99.
Line card number	15-16	Two bytes indicating a line card number (01-12). <b>Note:</b> If the message is a system message (rather than a call from a panel) the data in this field will be "\$00".
Open bracket	17	\$5B indicates the beginning of event data.
Event Data	Variable, beginning at position 18.	Account numbers, alarms, modifiers codes, system status messages, and so on. The 9800 can send up to 128 bytes of data per message to the automation computer. The data is a call from a panel if it has an account number and a system status message if it does not. The data field contains event data if the message is a call from a panel and system data if the message is a 9800 system message. The data is a link test if there is no data between the delimiting brackets (\$5B and \$5D) and the sequence number is "0000". If a message is a call from a panel, the first bytes after the open bracket will be \$23 (ASCII "#") followed by a 4-8 digit account. A field separator, \$7C (ASCII " ") will separate the account number from the first events. If there is more than one event, each event is separated by \$2F (ASCII "?") or by \$7C (ASCII "/"). Refer to SIA publication <i>Digital Communication Standard, February 1995 Revision</i> , for message syntax. <b>Listen-in And Hang Up Requests</b> Requests originating from the panel: In data sent to the 9800 by the panel, the event code "LF" indicates the beginning of a listen-in session. "LE" indicates the end of listen-in. See Section 2.3.2 for UL requirement on listen-in.

**Table 8-4: Data String Description**

Data Element	Byte Positions Occupied	Data Description
Close bracket	Variable, 1 byte long	\$5D indicates end of event data.
End of message indicator	Variable, 1 byte in long calls	\$0D is always the last character in a message. Even if the data is too large to be sent in one message, the end of message indicator appears at the end of the partial message.  If the message is too long to be contained in one line, a \$7C (ASCII " ") will precede the end of message indicator. In this case the header of the current message will be repeated in the second line with the remaining data.

**Table 8-5: Special Characters**

Hex Value	Meaning
\$7C	Field separator. Separates account number from what follows. Also indicates more data to come for messages that exceed 70 bytes.
\$23	Precedes an account number.
\$5B	Beginning of event data.
\$4E	New event.
\$4F	Old, or previously reported, event.
\$5D	End of event data.
\$0A	Beginning of message identifier.
\$0D	End of message indicator.
\$2F	Event separator.
\$09	Tab character, separates CRC from sequence number.

### 8.3.2 Basic Message Format

The basic format for any message coming from the 9800 to an automation computer is shown in Figure 8-4.

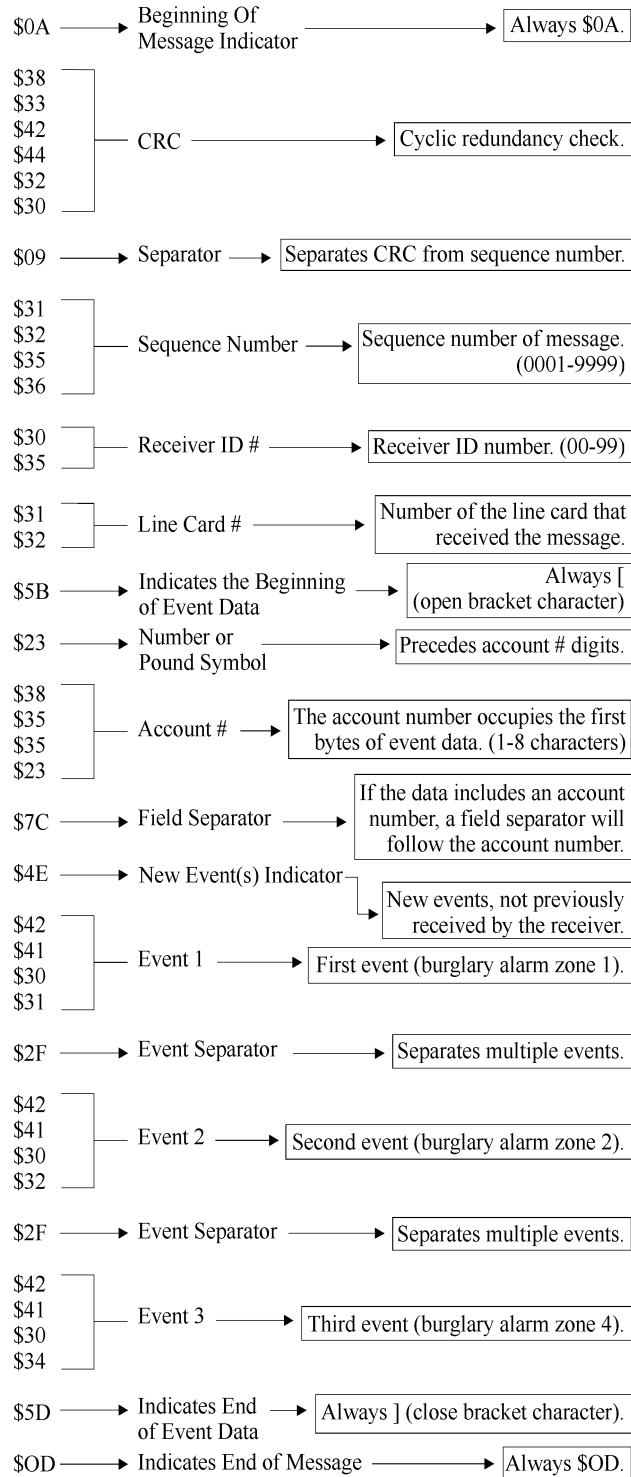

**Figure 8-4 Example Message**

*Note: Figure 8-4 is a sample only. sizes of data fields may vary in actual use.*

### 8.3.3 Modifier Codes

The 9800 supports the SIA modifier codes shown in Table 8-6 below.

**Table 8-6: Modifier Codes Used With The 9800**

CODE	MEANING AND USE
da	Date modifier. Followed by MM-DD-YY as in <i>da04-01-94</i> .
ti	Time modifier. Followed by HH:MM:SS, (:SS is optional), as in <i>ti05:45:52</i> .
ri	Area modifier. Followed by an area number (0000-9999, leading 0's not required).
id	Subscriber modifier. Used to identify the user causing the actions or events. (0000 - 9999)
pi	Peripheral ID modifier. Used to identify the device causing the action or event. (0000-9999)
ai	Automated ID modifier. Used to identify the logical function or timer causing the action or event and is included in the current block. (0000-9999)
ph	Telephone ID modifier. Identifies the index of the telephone service number used when the events occurred.

*Note: SIA codes are case-sensitive; modifiers are always lowercase*

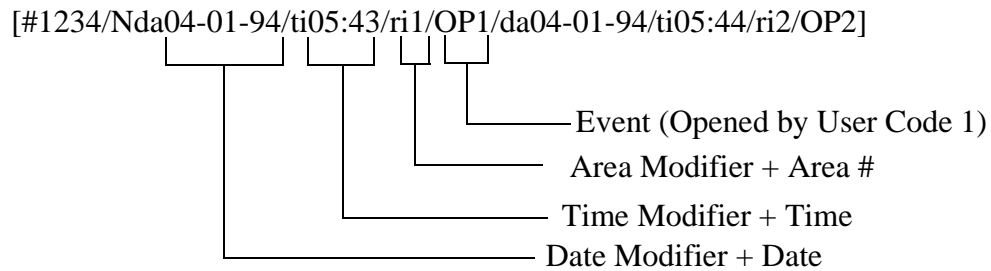

**Figure 8-5 Event Data With Modifier Codes**

### 8.3.4 Long Calls

The 9800 can send a maximum of 128 bytes in one message. When call data is more than 128 bytes, the 9800 breaks up the data into 128-byte chunks followed by a field separator, \$7C, (ASCII vertical bar character, |) and an end of message indicator, \$0D.

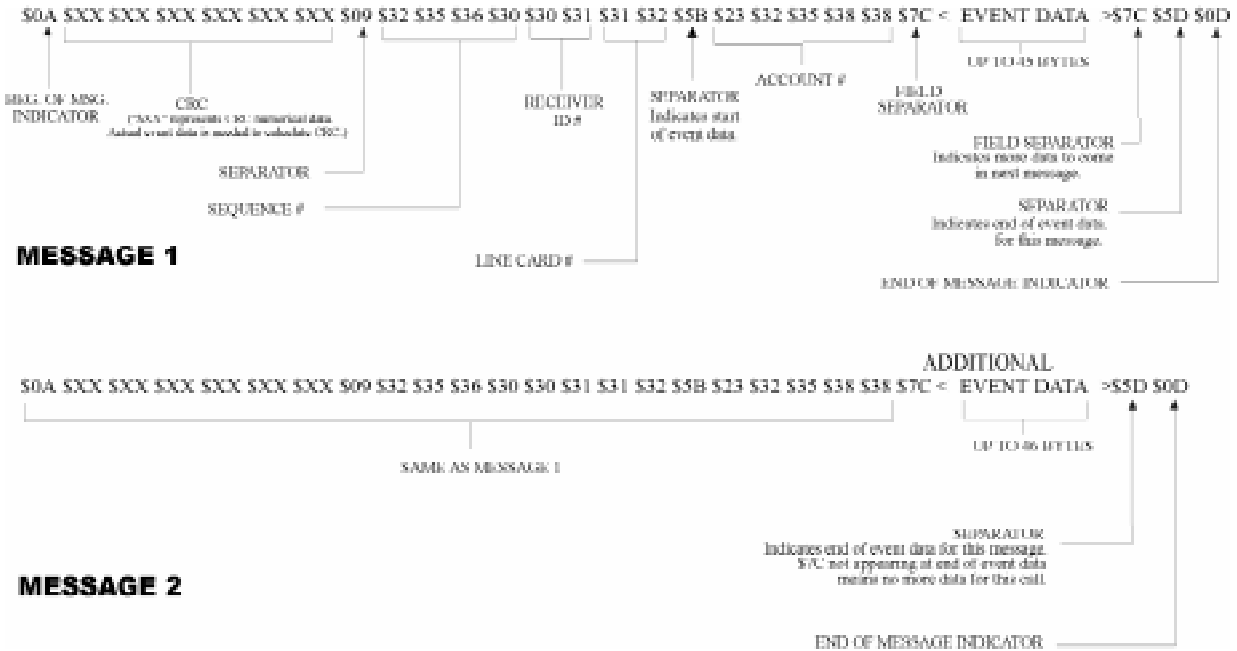

Figure 8-6 Long Call

### 8.3.5 System Status Messages

The 9800 can send 20 status messages. Status messages are a type of event data. They are differentiated from calls from panels because the first bytes after the open bracket are not an account number.

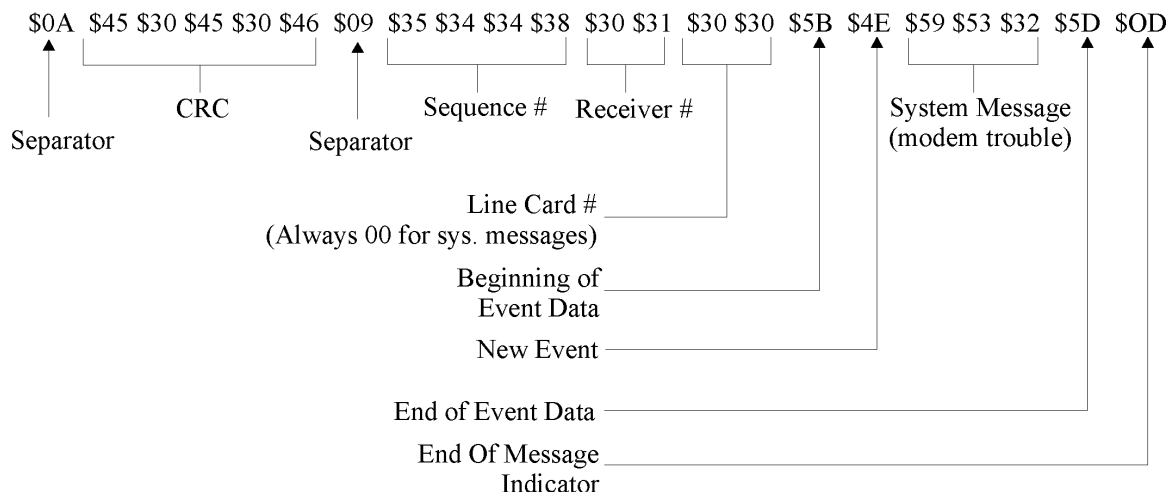

Figure 8-7 System Status Message

**Table 8-7 System Status Messages**

<b>CODE</b>	<b>PRINT-OUT</b>
AT	SYSTEM AC LOST
AR	SYSTEM AC RESTORE
CL	LOG ON OPERATOR (close report)
LB	LOCAL PROGRAM BEGIN
LE	LISTEN-IN END
LF	LISTEN-IN BEGIN
LR	LINE RESTORE L.C.#
LS	LOCAL PROGRAM END
LT	LINE FAULT L.C.#
LU	LOCAL PROGRAM FAIL
JD	SYSTEM DATE CHANGE
JT	SYSTEM TIME CHANGE
OP	LOG OFF OPERATOR (open report)
RR	SYSTEM POWER UP
RT	DATA LOST
VO	PAPER OUT (on-board printer)
VR	PRINTER RESTORE (for external printer)
VZ	PRINTER OFF-LINE
YC	COMPUTER TROUBLE
YD	TROUBLE L.C.#
YE	LINE CARD TROUBLE RESTORE
YK	COMPUTER TROUBLE RESTORE
YR	BATTERY RESTORE (system battery restore)
YT	BATTERY TROUBLE (system battery trouble)

### 8.3.6 Heart Beat

The SIA CIS protocol supports a periodic heart beat message to be sent to the automation computer. The heart beat message is used to verify the communication between the receiver and the automation computer. The sequence number of the heart beat message is always 0000.

## 8.3.7 Communication from a Computer to the 9800

### 8.3.7.1 ACKing and NACKing Data

The computer must respond to messages sent by the 9800 with a response packet.

The computer must ACK a received block by responding with the acknowledge packet (see Figure 8-8).

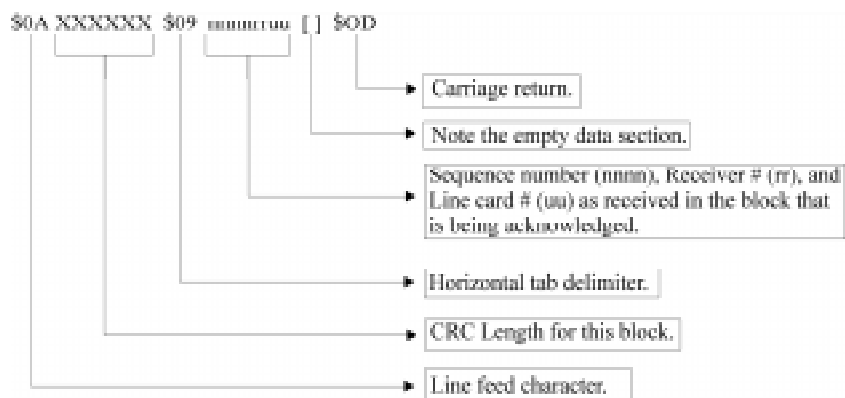

Figure 8-8 Sample ACK Message

The computer must NACK a received block by sending an ambiguous null response packet (see Figure 8-9).

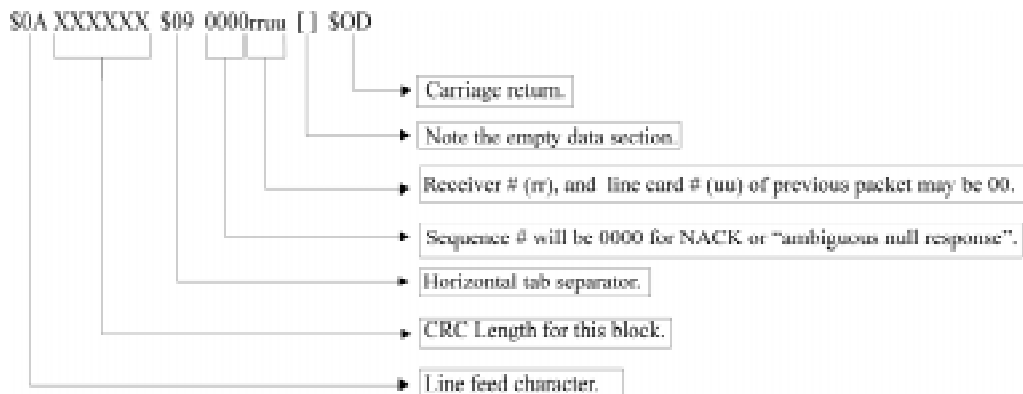

Figure 8-9 Sample NACK Message

*Note: If the computer fails to respond to the receiver's transmission within the timeout period, the packet will be considered to be NACKED, and the NACK logic on next page.*

A specific null response is sent when the computer's CRC agrees with the CRC sent in the message and the general format of the message appears to be correct (for example, the last byte is \$0D).

An ambiguous null response is sent whenever the computer suspects an error in the transmission of the message.

*Note: Refer to SIA CIS documentation for their format information.*



The 9800 ignores any other communication from the computer when it is awaiting ACKing or NACKing.

Generally, after two ambiguous null responses or two timeout periods of no response from the computer, the 9800 generates a "computer trouble" message.

- If the computer sends a specific null response, the 9800 will send any additional data in its buffer.
- If the computer sends an ambiguous null response, the 9800 will immediately re-send the data.
- If the computer sends an ambiguous null response or 2 timeout periods a second time, the 9800 will generate a computer trouble message and begin periodically sending the "Link Test" message to test the channel for recovery.

### **8.3.7.2 Link Test**

An ambiguous null response may be used to cause the receiver to send a link test to the automation computer. The receiver normally treats the ambiguous null response as an immediate time-out on any delay and transmits the next unacknowledged message. If the receiver has no unacknowledged message to transmit, the receiver will respond to the ambiguous null response with a link test message.

## 8.4 ITI Generic Computer Format

The ITI Generic Computer Output Format is designed to pass reported information through a RS-232 port to communicate with an automation computer. This format consist of four types of Generic Records--a Report Record, a Log Record, a Test Record, and a Okay Record.

### 8.4.1 Convention Used In This Section

An ITI digit in this section is an ASCII representation of a number from 0 to 61 as follows:

**Table 8-8: Number and ITI Digit Equivalent**

Number	Represented by ITI Digit
0 - 9	0 - 9
10 - 35	A - Z
36 - 61	a - z

### 8.4.2 Report Record

A report record is an alarm report from a control panel to the receiver.

The following is a general description of the information contained in a report record:

<\$0A><" 1 "><"B"><" 1 "><\$6A><" 2345 "><" 8 "><"b"><" 45 "><"A"><\$0D>

**Table 8-9: Report Record Components**

Character	Byte	Description
<\$0A>	0	ASCII (0A hex) line feed character that marks the beginning of a record.
<" 1 ">	1	Receiver ID digit. See Table 8-8 for value range..
<"B">	2	Phone line number digit. See Table 8-8 for value range.
<" 1 ">	3	Most significant digit of account number. For example, A in account AB-CDE.
<\$6A>	4	Control panel type/zone attribute code. See 8.4.2.1 for more information.
<" 2345 ">	5-8	Lower 4 digits of the account number. For example, B-CDE in account AB-CDE.
<" 8 ">	9	Group number. See Table 8-8 for value range.
<"b">	10	User ID number. will report 0 when a user number is not applicable. See Table 8-8 for value range.
<" 45 ">	11-12	Zone number. Two ASCII digits 00 - 99, A = 100, C = 110
<"A">	13	Alarm condition. See Table 8-13 for alarm codes and descriptions.
<\$0D>	14	ASCII (0D hex) carriage return marking the end of the record.

### 8.4.2.1 Control Panel Type and Zone Attribution Byte

Byte 4 (see Table 8-9) of the report record is divided into upper and lower nibbles. The upper nibbles (4 most significant bits) contain the code indicating the panel type.

**Table 8-10: Upper Nibble Description**

Upper Nibble Value	Description
2	Unknown Control Panel.
3	Non-ITI format
4	SX-III or SX-IVa
5	SX-IVb
6	SX-V
7	All other ITI panels.

The lower nibble (4 least significant bits) contains the code describing the zone attributes (unique with ITI panels). the definition of this field varies depending on which ITI panel the call was generated from. Refer to the installation manual of the ITI panel you wish to communicate with for communication specifications.

If the upper nibble is 3 (non-ITI format), the lower nibble is used to identify the panel.

**Table 8-11: Lower Nibble Description**

Lower Nibble Value	Description
0	Anything not listed below
1	Slow 3/1 format
2	Fast 3/1 format
3	Slow 3/1 extended format
4	Fast 3/1 extended format
5	Slow 4/1 format
6	Fast 4/1 format
7	Slow 4/2 format
8	Fast 4/2 format
9	Radionics 3/1 hex format
\$A	Radionics BFSK

### 8.4.2.2 Extended Panel ID Codes

When XID is set to 'Y' in programming mode (see Section 5.3.3.5 page 25) the extended panel ID replaces the control panel type as described in Section 8.4.2.1.

Table 8-12 list the XID codes (both the Hex and the ASCII character) for the ITI Generic computer output.

**Table 8-12: Extended Panel ID Codes (XID)**

XID Code		Panel Type
Hex Character	ASCII Character	
\$40	@	SX-III
\$50	P	SX-IVb
\$60	'	SX-V
\$70	p	Other ITI panel
\$72	r	SX-V Special
\$73	s	Commander
\$74	t	RF Commander
\$75	u	CareTaker +
\$77	w	Commander 2000
\$78	x	Security Pro 4000
\$79	y	UltraGard
\$7A	z	European Commander
\$7B	{	Simon
\$7E	~	New Panels

### 8.4.2.3 Alarm Codes

Table 8-13 list the alarm codes used in byte 13 of the report record, and a description of the alarm codes.

**Table 8-13: Alarm Code and Description**

<b>Alarm Codes</b>	<b>Description</b>
A	Alarm
B	Bypass
C	Closing Report
D	Dial out audio alarm
E	Exit fault
G	One-ring audio report
H	AC restore (non-ITI panels only)
I	Improper security code
J	Trouble
K	Key-chain access
L	Low battery
O	Opening report
P	Phone test
Q	AC failure (non-ITI panels only)
R	Cancel
S	Supervisory
T	Tamper alarm
U	Burglary (non-ITI panels only)
V	Instant audio alarm
W	Restoral
X	Medical/auxiliary emergency (FonSafe)
x	Medical/auxiliary emergency with audio verification (FonSafe)
Y	Police emergency (FonSafe)
y	Police emergency with audio verification (FonSafe)
Z	Fire emergency (FonSafe)
z	Fire emergency with audio verification (FonSafe)

### 8.4.3 Log Record

If Log Record (Log Rec) is enabled (see Section 5.3.3.5 page 26.), a pair of phone log records surrounds all report records generated by the reporting panel. The unused data field of the log record is filled with six "NoData" characters (see Section 5.3.3.5 page 26).

The following is an example of how a log record surrounds a report record:

```
<$0A><"1"><"1"><"0100"><"000000"><"N"><$0D> New Log Record
<Report Record> Report Record
<Report Record> Report Record
<$0A><"1"><"1"><"0100"><"000000"><"F"><$0D> Final Log Record
```

Table 8-14 list the components of a log record and their description.

**Table 8-14: Log Record Components and Description**

Character	Description
<\$0A>	Start or record indicator (line feed).
<"1">	Receiver ID number.
<"1">	Phone line number.
<"0100">	Reference number, equals four ASCII bytes ranging from 0001-9999. Reference number 100 show.
<"000000">	Six No Data characters. Valid characters are: 0-9, A-Z, a-z, Space, !, -, _, ., /, &, *, #, ?, <sup>E</sup> c. See Section 5.3.3.5 page 26.
<"N">	New or start of log record.
<"F">	Final or end of log record.
<\$0D>	End of record indicator (carriage return).

### 8.4.4 Test Record

A test record is sent when panel date/time is updated.

The following is an example of a test record:

```
<$0A><"IT IRCV 234A"><$0D>
```

**Table 8-15: Test Record Components and Description**

Character	Description
<\$0A>	Start of record (line feed).
<"IT IRCV 234A">	Predefined test record string. The predefined test string is automatically set when ITI Generic format is chosen to communicate with automation computer.
<\$0D>	End of record indicator (carriage return).

## 8.4.5 OKAY Record

When the automation computer sends a supervisory character to the 9800 receiver, the receiver will return with an OKAY record. An OKAY record (heartbeat) is sent periodically to the automation computer. How often the OKAY record is sent is set through programming (see Section 5.3.3.5 page 22).

*Note: The supervisory character is programmable. See Section 5.3.3.5 page 26.*

The following is an example of an Okay record:

```
<$0A><"00 OKAY @"><$0D>
```

**Table 8-16: Okay Record Components and Description**

Character	Description
<\$0A>	Start of record (line feed).
<"00 OKAY @">	Predefined okay record string. The predefined okay record string is automatically set when ITI Generic format is chosen to communicate with automation computer.
<\$0D>	End of record indicator (carriage return).

## 8.4.6 ACKing and NACKing Data

After the end of message byte (<0Dh>) is sent by the receiver, the automation computer will respond with an ACK (<\$06>) or NACK (<\$15>). This response can be delayed between 1 byte time (depending on the baud rate) and the ACK timeout period. See Section 5.3.3.5 page 24.

If the receiver doesn't get a ACK within the ACK timeout period or receive a NACK from the automation computer, it will re-transmit the data.

After two NACKs or two ACK timeout the receiver will generate a Computer Trouble message. When a computer trouble message is generated, the receiver will continually send a heartbeat until it receives an ACK from the automation computer. When communication is restored, a Computer Trouble Restore message will be generated.

## 8.5 ITI Computer Interface Format

---

ITI Computer Interface format consists of four types of records; report record, test record supervisory record, and log record (see Table 8-18).

### 8.5.1 Convention Used In This Section

An ITI digit in this section is an ASCII representation of a number from 0 to 61 as follows:

**Table 8-17: Number and ITI Digit Equivalent**

Number	Represented by ITI Digit
0 - 9	0 - 9
10 - 35	A - Z
36 - 61	a - z

### 8.5.2 General Record Structure

Each record begins with <"|"><Record Type> field (see Table 8-18 for record identifiers) and end with a <"|"><Cksum/Ctrl> field. Any fields within a record may be included in an individual record as needed.

A record is made up of field of data (in varying lengths), and each field within a record begins with a <"|"> character. The <"|"> is followed by a field identifying character. Individual field identifiers are unique to the specific record where they are contained. For example, a |L field in a report record has a different meaning than an |L field of a test record and so on. There is no specific order to the fields of a record, with the exception that it will begin with the record type and end with a checksum/control field.

After the checksum/control field each record is terminated with a carriage return (<\$0D>).

**Table 8-18: Type of Record Identifiers**

Field Identifier	Definition
[R	Report record
[T	Test record
[S	Supervisory record
[L	Log record



The following is an generic example of a transmitted message record:

```
<"|["><Record Type><Info fields...><"|]"><Cksum/Ctrl><$0D>
```

**Table 8-19: Record Components**

Character	Description
<" [">	Start of record indicator.
<Record Type>	Record type. See table Table 8-18.
< Info fields...>	Information fields. See Table 8-21.
<" ]">	End of information fields indicator.
<Cksum/Ctrl>	Checksum/control field. See Section 8.5.7.
<\$0D>	End of record indicator.

### 8.5.3 Report Record

A report record is generated when a control panel calls into the receiver for any reason.

The following is an example report record (see also Table 8-20):

```
<"|["><"R"><"|IA1"><"|LB"><"|A123456"><"|V55600"><"|D0514"><"|T1019"><"N0005"><"|Z1"><"|CA"><"|]"><Cksum/Ctrl><$0D>
```

Table 8-20 list the components of a report record and their description.

**Table 8-20: Report Record Components and Description**

Character	Description
<"   [ ">	Start of record indicator.
<R>	Report record identifier.
<"   IA1 ">	Unit ID = A, followed by receiver ID = 1.
<"   LB ">	Line Card #, B = 11. Acceptable values are 0-9, A (= 10), B (=11), C (=12).
<"   A123456 ">	Account Number.
<"   V55600 ">	Panel (see Table 8-22) and revision number. In this example the panel = SX-V and the revision is 5600.
<"   D0514 ">	Date of the report in mmdd format. mm = Month, dd = Day
<"   T1019 ">	Time of report in hhmm format. hh = Hour, mm = Minutes
<"N0005">	Reference number. See Section 4.6.3. 0001-9999
<"   Z1 ">	Zone number. One to four alphanumeric characters are acceptable values.
<"   CA ">	Condition code indicating the nature of the reported message. See Table 8-3.
<"   ] ">	End of information fields indicator.
<Cksum/Ctrl>	Checksum/control field. See Section 8.5.7.
<\$0D>	End of record indicator.

### 8.5.3.1 Information Field Identifiers

The following characters signify which data is contained in a information field:

**Table 8-21: Information Field Identifiers**

Field Identifier	Description	Acceptable Values
I	System identifier. A unit ID (always an A) and the receiver ID digit. See 5.3.4.2 to set receiver ID.	"A" followed by 0-9.
O	Communication Lock (Comm-Lock) usage.	0 = Not Supported (4) 1 = Phone lock 2 = Central Station Lock 3 = No lock used
M	Audio (Listen-in) usage.	0 = Not Used (4) 1 = Instant mode 2 = Dial out mode 3 = One ring mode
L	Line Card number.	See Table 8-17 for acceptable values.
A	Account number.	Three to six alphanumeric characters. If the account is more than 6 characters the account will be truncated to the last six characters.
P	Protection level of panel.	Two bytes, the first indicates the previous protection level and the second indicates the current protection level.
V	Panel type and revision.	One panel type code byte followed by a 4-digit revision number. See Table 8-22.
G	Group and attribute information.	Contact ITI for group and attribute information.
D	Date of report.	In mmdd format, where mm = month, and dd = day.
T	Time of report	In hhmm format, where hh = hour, and mm = minutes.
N	Reference number.	0001-9999. See also Section 4.6.3.
Z	Zone number.	One to four alphanumeric characters.
U	User number.	See Table 8-17 for acceptable values.
K	Dealer key numbers. For Commander 2000 only.	Values from 00-99.
S	CPU sub-unit number	Values from 0-9
C	Condition code indicating the nature of the reported message. See Table 8-3.	See Table 8-3 for condition code values.

### 8.5.3.2 Panel Type Characters

The following table lists the characters used for panel types and which panel they refer to:

**Table 8-22: Panel Type Characters**

Character	Panel Type
0	Unknown type
3	SX-III or SX-IVA
4	SX-IVB
5	SX-V
9	FonSafe
A	Commander
B	SX-V Special
C	Magnetic card reader
D	Euro Commander
E	Security Pro 4000
K	HaborGard
M	UltraGard
N	Network Security
P	Pin Point
R	RF Commander
S	Commander 2000 or LifeGard
T	CareTaker +
U	MeterMinder
V	Protector

**Table 8-2: Panel Type Characters (Continued)**

Z	Nutone
a	3/1
e	3/1 extended
i	4/1
m	4/2
r	Radionics BFSK
s	SIA DSC
t	Contact ID
u	SIA 2000
v	Ademco Touch Tone
w	Acron Touch Tone
x	Westec Touch Tone
y	Ademco DTMF 4/2
z	Ademco DTMF 4/1
#	SIA D1
\$	FSK 0
%	FSK 1
&	FSK 2
(	FBI 4/3/1

### 8.5.3.3 Condition Codes

Condition codes are a one-digit character which indicates the nature of the call from a control panel to the receiver.

Table 8-3 lists the different condition codes and their descriptions:

**Table 8-3: Condition Codes and Descriptions**

Condition Code	Description
A	Alarm
B	Bypass
C	Closing Report
E	Exit Fault
F	Force Arm
G	Burglary (non-ITI panels only)
H	AC Restore (non-ITI panels only)
I	Improper Security Code
J	Trouble
L	Low battery
M	Medical/Auxiliary Emergency

**Table 8-3: Condition Codes and Descriptions**

Condition Code	Description
N	Fire Emergency
O	Opening Report
P	Power Failure (non-ITI panels only)
Q	Police Emergency
R	Restoral
S	Supervisory
T	Tamper
U	Status Report (non-ITI panels only)
X	Cancel
Z	Phone Test
c	Key Access Closing Report
o	Key Access Opening Report

### 8.5.4 Test Record

A test record is sent when the panel date/time is updated.

The following is an example of a test record:

```
<" | [ "><"T"><" | IA1 "><" | D970514 "><" | T145056 "><" | V042097 ">
<" | L6.1 "><" | ] "><Cksum/Ctrl><$0D>
```

Table 8-4 lists the information fields contained in a test record and their descriptions:

**Table 8-4: Test Record Information Fields and Descriptions**

Character	Description	Acceptable Values
I	System identifier. A unit ID (always an A) and the receiver ID digit. See 5.3.4.2 to set receiver ID.	"A" followed by 0-9.
D	Date	Current date in yymmdd format yy = year, mm = month, dd = day.
T	Time	Current time in hhmmss format hh = hours, mm = minutes, ss = seconds.
V	Software version	In date format.
L	ITComp revision level.	Two digits separated by a decimal point.

## 8.5.5 Supervisory Record

When the automation computer sends a supervisory character to the receiver, the receiver will answer with a supervisory record. An supervisory record (heartbeat) is sent periodically to the automation computer. How often the supervisory record is sent is set through programming (see Section 5.3.3.5 page 22).

The following is an example of a supervisory record:

```
<" | [ "><"S"><" | IA1 "><" | D970514 "><" | T145056 "><" | V042097 ">
<" | L6.1 "><" | ] "><Cksum/Ctrl><$0D>
```

Table 8-4 lists the information fields contained in a test record and their descriptions.

## 8.5.6 Log Records

If Log Record (Log Rec) is enabled (see Section 5.3.3.5 page 26.), a pair of phone log records surrounds all report records generated by the reporting panel. The unused data field of the log record is filled with six "NoData" characters (see Section 5.3.3.5 page 26).

The following is an example of how a log record surrounds a report record:

```
<"|["><"L"><"|IA1"><"|L1"><"|Nooo1"><"|S970425080020"><"|]"><Cksum/Ctrl><$0D> Start Log Rec
<Report Record> Report Rec
<Report Record> Report Rec
<"|["><"L"><"|IA1"><"|L1"><"|Nooo1"><"|E970425080110"><"|]"><Cksum/Ctrl><$0D> End Log Rec
```

Table 8-5 lists the information fields contained in a log record and their descriptions.

**Table 8-5: Log Record Information Fields And Descriptions**

Character	Description	Acceptable Values
I	System identifier. A unit ID (always an A) and the receiver ID digit. See 5.3.4.2 to set receiver ID.	"A" followed by 0-9.
L	Line Card number.	See Table 8-17 for accepted values.
N	Reference number.	0001-9999
S	Date and time.	YYMMDDhhmmss format where YY = Year, MM = Month, DD = Day, hh = hour, mm = minutes, dd = seconds.
E	Date and time.	YYMMDDhhmmss format where YY = Year, MM = Month, DD = Day, hh = hour, mm = minutes, dd = seconds.

## 8.5.7 Checksum/Control Field

The last field of every record is the checksum/control field. This field contains an upper case letter followed by four ASCII hexadecimal digits. Contained in these five characters are three controls to help guarantee data integrity between the receiver and the automation computer.

The first control is the Sequence Control Character (SCC). This is a letter code which cycles from "A" to "Z" continually, changing successively with each new record transmitted.

*Note: If the receiver has to repeat a record in response to a NACK from the automation computer, the same SCC is sent both times.*

The first digits sent (following the SCC) are the two least significant digits of an additive checksum for the record from the first "|" character up to and including the SCC.

See Table 8-6.

The last two digits in the record are an XOR checksum. The XOR checksum starts with a value FFh. This value is XORed against the first byte in the record. The result is XORed against the next byte and so on, up through the SCC. See Table 8-6.

The following is an example of a checksum/control field:

[X]A49E0

**Table 8-6: Checksum Verification Process**

Character	ASCII Code	Additive Checksum	XOR Checksum
	7C	00 + 7C = 7C	FF ^ 7C = 83
[	5B	7C + 5B = D7	83 ^ 5B = D8
X	58	D7 + 58 = 12F	D8 ^ 58 = 80
	7C	12F + 7C = 1AB	80 ^ 7C = FC
]	5D	1AB + 5D = 208	FC ^ 5D = A1
A	41	208 + 41 = 249	A1 ^ 41 = E0

## 8.6 SIA 2000

---

Not available at this time.

## 8.7 SK EXP (Silent Knight Expanded)

Because of the additional features and program capabilities of the 9800 receiver over its predecessor the 9000 receiver, it was necessary to develop a new "Expanded" automation protocol.

Silent Knight Expanded (SK EXP) protocol addresses these needs. The following sections describes the three different types of data blocks (system message, heart beat message, and call message) that the SK EXP will send to the automation computer, and the components of these data blocks.

Each of these types of data blocks are preceded with a SKE header block. At the end of each message is an "End of message indicator" (<\$0D> or carriage return) preceded by a Validation Byte (or V-Byte used for error-checking). See Section 8.7.5.

### 8.7.1 SKE Header Block

The header block consists of 18 bytes of data and precedes all of the data blocks.

The following is an example of an SKE header.

**Example:**

<Identifier><Date><\$22><Time><\$22><Rec#><\$22><Ref#><\$22>

Table 8-7 describes the components of an SKE header block.

**Table 8-7: SKE Header Block Components Description**

Character	Description	Acceptable Values
<Identifier>	Message type identifier.	\$02 System Message \$03 Heart Beat Message \$26 Call Message
<Date>	Date information, consisting of six ASCII bytes.	MMDDYY format where MM = Month, DD = Day, YY = Year.
<\$22>	Separator	N/A
<Time>	Time information, consisting of six ASCII bytes	HHMMSS format, where HH = Hour, MM = Minutes, SS = Seconds.
<\$22>	Separator	N/A
<Rec#>	Receiver ID number.	01-99
<\$22>		
<Ref#>	Reference number, consisting of four ASCII bytes.	0001-9999 (0000 is reserved for link tests.)
<\$22>	Separator	N/A



## 8.7.2 Call Message Block

A call message is generated any time a control panel calls into the receiver. This type of report will be the most frequent message block received by the automation computer from the receiver.

Embedded in this message are the account number, time/date stamp, specific event information, along with any other miscellaneous information such as, caller Id, listen-in, etc.

The following is a generic example of a call message block:

### Example:

```
<SKE header><Fmt#><LC#><Panel Data><V-byte><$0D>
```

Table 8-7 describes the components of a call message block.

**Table 8-8: Call Message Components and Description**

Character	Description	Acceptable Values
<SKE header>	SKE header block of data.	See Section 8.7.1.
<Fmt#>	Dialer format number containing three ASCII digits.	See 8.7.2.1.
<LC#>	Line Card number containing two ASCII digits.	00-99
<Panel Data>	Contains account number, time/date stamp, caller ID information, listen-in, reason for call, zone number, etc..	See 8.7.2.2.
<V-byte>	Validation byte.	See Section 8.7.5.
<\$0D>	End of message indicator (carriage return).	N/A

### 8.7.2.1 Dialer Format

The Silent Knight Expanded format takes advantage of additional format numbers and outputs information with greater detail about the dialer format.

Table 8-9 list the dialer format code and indicates the type of dialer associated with that number.

**Table 8-9: Dialer Format Types By Code**

Code	Dialer Type	Code	Dialer Type
003	SIA-2000	035	Pulse tone 4/1
004	SIA DCS	036	Sescoa Franklin 4/1
010	ITI SX-IVA	037	Ademco/Silent Knight 4/1
011	ITI PinPoint	038	Extended 4/1
012	ITI RF Commander	040	Pulse Tone 4/2
013	ITI UltraGard/Pro 1	041	Ademco/Silent Knight 4/2
014	ITI CareTaker +	042	FBI 4/2
015	ITI SX-V	043	Extended 4/2
016	ITI Commander 2000	046	Radionics 3/1
017	ITI HarborGard	047	Radionics 3/1 with Checksum
018	ITI Reserved	048	Radionics 4/2 with Checksum
019	ITI Vector	049	Sescoa Superspeed
020	ITI Hardwire Commander	050	Contact ID
021	ITI SX-V Special	051	Ademco Touch tone
022	ITI Marsden	052	Acron Touch Tone
023	ITI Network Sec	053	Westec Touch Tone
024	ITI Nutone	054	Ademco Express
025	ITI SX-IVB	055	SIA D1
030	Pulse Tone 3/1	060	BFSK
031	Sescoa Franklin 3/1	061	Silent Knight FSK0/FSK80
032	Ademco/Silent Knight 3/1	062	Silent Knight FSK1/FSK81
033	Extended 3/1	063	Silent Knight FSK2/FSK86

### 8.7.2.2 Panel Data

Panel data contains all the data that pertains to the control panel that dialed into the receiver, such as the account number, what kind of alarm, the zone number, caller ID information, etc. Each record contains an identifier byte followed by data.

Table 8-10 lists the characters used as identifiers and a description of each.

**Table 8-10: Panel Data Identifiers and Descriptions**

Character	Description
\$05	Account number field
11h	Caller ID name
12h	Caller ID phone number
13h	Caller ID, others
\$22	Event field (Good Data)
\$23	Event field (Bad data sent as hex-ASCII dump). See Section 8.8
\$2A	Listen-in call indicator. See Section 8.7.2.3.
\$2B	Trap call indicator. See Section 8.7.2.4
\$2C	Long call indicator. See Section 8.7.2.5.

*Note: Caller ID information is only sent from the receiver if the incoming call has no data contained in it. If the incoming message contains any data (valid or invalid) no Caller ID information will be sent*

**Example:**

<\$26><“051697”><\$22><“081356”><\$22><“01”><\$22><“0001”><\$22><“004”><“01”>  
 <12h><“1-800-328-0103”><11h><“Silent Knight”><\$05><“123456”><\$22><“BA01”>  
 <\$22><“DC2”><\$22><“RP”><V-byteV-byte><\$0D>

Table 8-11 describes what each component of the call message means.

**Table 8-11: Call Message Components**

Component	Description
<\$26>	Call message indicator.
<“051697”>	Date-May 16th, 1997
<\$22>	Separator
<“081356”>	Time-8:13:56 am
<\$22>	Separator
<“01”>	Receiver number-1.
<\$22>	Separator
<“0001”>	Reference number-0001
<\$22>	Separator
<“004”>	Expanded dialer format -SIA DCS
<“01”>	Line Card number-01
<12h>	Caller ID phone number indicator
<“1-800-328-0103”>	Caller ID phone number
<11h>	Caller ID name field indicator
<“Silent Knight”>	Caller ID name
<\$05>	Account number field indicator
<“123456”>	Account number-123456
<\$22>	Good data field indicator.
*<“BA01”>	Call event code-Burglary alarm, Zone 01.
<\$22>	Good data field indicator.
*<“DC2”>	Call event code-Access Closed, Door 2
<\$22>	Good data field indicator.
*<“RP”>	Call event code-Automatic Test
<V-byte>	Validation Byte (V-byte). See Section 8.7.5.
<\$0D>	End of message indicator

\* Note: Refer to SIA publication “Digital Communication Standard, February 1995 Revision”, or later for message syntax.

### 8.7.2.3 Listen-in Indicator

If message sent to the automation computer contains a <\$2A> (Listen-In indicator) followed the 3-ASCII digits, the control panel calling is requesting the receiver put the phone line into listen-in mode. See Section 2.3.2 for UL requirement on listen-in.

The 9800 receiver uses the following standards to identify a listen-in account:

- First, the receiver searches for an embedded listen-in event in the panel data, depending on whether or not the reporting format supports listen-in.
- Second, the receiver compares the account number to those stored in the “listen-in accounts” list. See Section 5.4.2.3.
- Third, the receiver scans the line card flash record to determine if the listen-in is enabled for the line card.
- Fourth, if the above standards have been satisfied, the receiver sends the automation computer the listen-in indicator.

The following is an example of a call message containing a listen-in indicator:

#### Example:

<FMT#><LC#><\$05><123456><BA01><\$2A><“060”><V-byte><\$0D>

Table 8-12 describes the components of a call message containing a listen-in indicator.

**Table 8-12: Call Message With Listen-in Data**

Character	Description
<SKE header>	SKE header block of data. See Section 8.7.1.
<FMT#>	Dialer format number containing three ASCII digits. See 8.7.2.1
<LC#>	Line Card number containing two ASCII digits.
<\$05>	Panel Data. See 8.7.2.2.
<123456>	
<BA01>	
<\$2A>	Listen-in indicator.
<“060”>	Listen-in time period in seconds. Three ASCII characters- 60 seconds.
<V-byte>	Validation byte. See Section 8.7.5.
<\$0D>	End of message indicator.

*Note: If the control panel calling does not include the listen-in period in the reporting message, the receiver uses the listen-in timeout programmed in the line card. See Section 5.4.2.3.*

### 8.7.2.4 Trap Account Indicator

If the call message being transmitted to the automation computer contains a <\$2B> preceding the V-byte, then the call has been trapped. See Section 5.4.2.4 for trap account information.

The following example shows the call message data after the SKE header and the panel data:

**Example:**

....<\$2A><"020"><\$2B><V-byte><\$0D>

Table 8-13 describes the components of a trap account indicator string.

**Table 8-13: Trap Account Indicator Components**

Character	Description
<\$2A>	Listen-in indicator.
<"020">	Listen-in period-20 seconds.
<\$2B>	Trap account indicator.
<V-byte>	Validation Byte. See Section 8.7.5.
<\$0D>	End of message indicator.

### 8.7.2.5 Long Call Indicator

The maximum number of bytes the SK Expanded protocol can send to the automation computer in a single packet is 128. If a panel sends more than 128 bytes, the receiver will break the panel information data down into groups of 128 bytes or less. To alert the automation computer that this is being done, a long call indicator (<\$2C>) will be added before the V-byte to indicates more data is to follow.

The entire data string in a long call contains the same values in the header block. The last data string of the long call will not contain a long call indicator prior to the V-byte.

The example below shows the long call data excluding the SKE header and the panel data.

....<\$2C><V-byte><\$0D>

*Note: Some panels are capable of transmitting multiple account information in a single call. The 9800 receiver will treat a call with multiple accounts as multiple calls with a single account and will divide the call into multiple data blocks. However, to distinguish them from a call with a single account, each data block of a call with multiple accounts will contain the same reference number and a long call indicator with the exception of the last block of data.*

### 8.7.2.6 Bad Data Field Indicator

If the data received by the 9800 is garbled or parts are missing the receiver will send a bad data indicator (<\$23> used in the event block as a separator) before the block of corrupted data. A bad data block will contain a hex-ASCII dump of the data in ASCII form.

The example below shows a bad data field indicator excluding the SKE header and some of the panel data.

**Example:**

```
<$23><aaaaaaaa><$23><bbbbbb><$05><“123456”><$22><“BA01”><V-byte><$0D>
```

Table 8-14 shows the character in the above example and gives a description for each.

**Table 8-14: Bad Data Field Indicator Components**

Character	Description
<\$23>	Bad data indicator
<aaaaaaaa>	Bad data ASCII hex data dump.
<\$23>	Bad data indicator
<bbbbbb>	Bad data ASCII hex data dump.
<\$05>	Account number field indicator
<“123456”>	Account number.
<\$22>	Separator - Good data.
<“BA01”>	Panel Data. See 8.7.2.2
<V-byte>	Validation Byte. See Section 8.7.5.
<\$0D>	End of message indicator.

### 8.7.3 System Message Block

System messages originate from the receiver and are sent to the automation computer. The length of the message is dependent on its function of the message. All system messages are sent separately from one another and from other types of messages.

A typical system message looks like this:

```
<SKE header><System><V-byte><$0D>
```

**Example:**

```
<$02><“051697”><$22><“124039”><$22><“02”><$22><“0001”><$22><70h><“01”>  
<V-byte><$0D>
```

Table 8-15 lists the components of the system message block example and gives a description for each of them.

**Table 8-15: System Message Components**

character	Description
<\$02>	Message type identifier.
<“051697”>	Date information, consisting of six ASCII bytes.
<\$22>	Separator
<“124039”>	Time information, consisting of six ASCII bytes
<\$22>	Separator
<“02”>	Receiver number
<\$22>	Separator
<“0001”>	Reference number, consisting of four ASCII bytes.
<\$22>	Separator
<\$70>	System event - line card trouble. See 8.7.3.1 for list of system messages.
<“01”>	Line Card number - 01.
<V-byte>	Validation Byte (V-byte). See Section 8.7.5.
<\$0D>	End of message indicator.



### 8.7.3.1 System Messages

Table 8-16 lists all the system messages that the receiver can send to the automation computer.

**Table 8-16: System Messages**

System Message	Description
<\$41><2 ASCII Byte LC #>	Common Listen-in Begin, followed by the line card number.
<\$42><2 ASCII Byte LC #>	Common Listen-in End, followed by the line card number.
<\$43><2 ASCII Byte LC #>	Common Listen-in Extended, followed by the line card number.
<\$44><2 ASCII Byte LC #>	PBX Listen-in Begin, followed by the line card number.
<\$45><2 ASCII Byte LC #>	PBX Listen-in Busy, followed by the line card Line card number.
<\$46><2 ASCII Byte LC #>	Manually Aborted Call, followed by the line card number.
<\$61>	System Power Up
<\$62><2 ASCII Byte User #>	Local Program Begin, followed by the user number.
<\$63><2 ASCII Byte User #>	Local Program End, followed by the user number.
<\$64><2 ASCII Byte User #>	Local Program Fail, followed by the user number.
<\$65><2 ASCII Byte User #>	System Date Change, followed by the user number.
<\$66><2 ASCII Byte User #>	System Time Change, followed by the user number.
<\$67>	Message Queue Above Warning
<\$68>	Message Queue Below Warning
<\$69>	Message Queue Full
<\$6A>	Message Queue Full Restore
<\$6B>	Printer Off Line
<\$6C>	Printer Paper Out
<\$6D>	Printer Restore
<\$6E><2 ASCII byte LC #>	Line Card Added
<\$6F><2 ASCII byte LC #>	Line Card Deleted
<\$70><2 ASCII byte LC #>	Line Card Trouble
<\$71><2 ASCII byte LC #>	Phone Line trouble
<\$72><2 ASCII byte LC #>	Line Card Trouble Restore
<\$73><2 ASCII byte LC #>	Phone Line Restore
<\$77>	AC Lost
<\$78>	AC Restore
<\$79><4 ASCII byte Receiver Model #>	Battery/DC Trouble
<\$7A><2 ASCII byte Receiver Model #>	Battery/DC Trouble Restore
<\$7B>	Computer Trouble
<\$7D>	Computer Restore
<\$7E><2 ASCII byte User #>	Log Off Operator
<\$7F><2 ASCII byte User #>	Log On Operator

## 8.7.4 Heart Beat Message Block

A heartbeat is a message sent to the to the automation computer which is used to supervise the communication link between the receiver and the automation computer. A heart beat can be identified by the reference number used in the SKE header which will always be 0000. How often the heart beat message is sent to the automation computer is a programmable option in the receiver. (See Section 5.3.3.5.)

A typical heart beat message looks like this:

### Example:

<\$03><“051997”><\$22><“074905”><\$22><“01”><\$22><“0000”><\$22><V-byte><\$0D>

Table 8-17 list the components shown in the above example and gives a description for each of them.

**Table 8-17: Link Test Components**

Component	Description
<\$03>	Message type identifier.
<“051997”>	Date information, consisting of six ASCII bytes.
<\$22>	Separator
<“074905”>	Time information, consisting of six ASCII bytes
<\$22>	Separator
<“01”>	Receiver number
<\$22>	Separator
<“0000”>	Reference number, consisting of four ASCII bytes.
<\$22>	Separator
<V-byte>	Validation Byte (V-byte). See Section 8.7.5.
<\$0D>	End of message indicator.

## 8.7.5 Validation Byte (V-Byte)

A V-byte always precedes the end of message indicator and is the only error checking used by the SK EXP communication format.

The following equations are used to calculate the V-byte:

1. Add the 1st byte of the message to the 2nd byte.
2. Clear bit 7 of the result.
3. Set bit 6 of the result.

4. Add this result to the next byte of the message.
5. Repeat steps 2 through 4 until the last byte of the event data. (Up to and including the byte preceding the validation byte.) The range of the sum is from \$40 to \$7F.

### **8.7.6 ACKing and NACKing Data**

After the end of message byte (<\$0D>) is sent by the receiver, the automation computer will respond with an ACK (<\$06>) or NACK (<\$15>). This response can be delayed between 1 byte time (depending on the baud rate) and the ACK timeout period. See Section 5.3.3.5 page 24.

If the receiver doesn't get a response within the ACK timeout period or receive a NACK from the automation computer, it will retransmit the data.

After two NACKs or two ACKs timeout, the receiver will generate a *Computer Trouble* message. When a computer trouble message is generated, then the receiver will continually send a heartbeat until it receives an ACK from the automation computer. When communication is restored, a *Computer Trouble Restore* message will be generated.

## 8.7.7 Commands Initiated by the Automation Computer

Typically all communications are initiated by the receiver, however, there are several commands available to the automation computer to control or request information from the receiver. The automation computer may send these requests only when the receiver is not transmitting data to the automaton computer.

The following sub-sections show the message format that must be sent from the automation computer to the receiver in order that these command requests function properly.

The receiver will respond to these requests from the automation computer with one of the following messages:

**Table 8-18: Response Messages by the 9800 Receiver**

ASCII Hex Character	Character Name	Description
\$06	ACK	The request is granted.
\$15	NACK	The request is unrecognized because of one of the following reasons: <ul style="list-style-type: none"> <li>• Checksum error</li> <li>• Invalid request code/format</li> </ul>
\$1B	ESC (Escape)	The request is refused because of one of the following: <ul style="list-style-type: none"> <li>• Unauthorized access</li> <li>• Invalid receiver/line card number</li> <li>• Receiver/line card is busy</li> <li>• Invalid PBX string</li> <li>• Account list full</li> <li>• Account number not found in the account list</li> </ul>

Table 8-19 lists which request can be made from the automation computer by request identifiers.

**Table 8-19: Command Requests by Identifiers**

Command Request Identifier	Description
\$4A	Log-on request
\$4B	Log-off request
\$05	Hang up request
\$04	Add a listen-in account. (This adds an account number to the listen-in account list.)
\$03	Delete a listen-in account. (This deletes an account number from the listen-in account list.)
\$4C	Listen-in extend request.
\$48	Listen-in end request.
\$49	PBX string request.
\$02	Add a trap account. (This adds an account number to the trap account list.)
\$01	Delete a trap account. (This deletes an account number from the trap account list.)
\$0D	Link test request.

### 8.7.7.1 Remote Log-on/Log-off

You must log-on to the receiver before you can change any system program options. Remote log-in and log-off commands can be sent from the automation computer to the receiver.

#### To Log-in:

<\$4A><Receiver ID><\$22><User PIN><V-byte><\$0D>

**Table 8-20: Log-in Request Components**

Component	Description
<\$4A>	Command request identifier. See Table 8-19.
<Receiver ID>	Receiver ID number. 1 or 2 ASCII digits.
<\$22>	Separator
<User PIN>	The users PIN code.
<V-byte>	Validation Byte (V-byte). See 8.7.5.
<\$0D>	End of message indicator.

**To Log-off:**

<\$4B><Receiver ID><\$22><User PIN><V-byte><\$0D>

**Table 8-21: Log-off Request Components**

Component	Description
<\$4B>	Command request identifier. See Table 8-19.
<Receiver ID>	Receiver ID number. 1 or 2 ASCII digits.
<\$22>	Separator
<User PIN>	The user's PIN code.
<V-byte>	Validation Byte (V-byte). See 8.7.5.
<\$0D>	End of message indicator.

**8.7.7.2 Force Hang-up Request**

This command is used to immediately hang up the phone line regardless of the state of the line card.

**To Force Hang-up:**

<\$05><Receiver ID><\$22><LC#><V-byte><\$0D>

**Table 8-22: Force Hang-Up Request Components**

Component	Description
<\$05>	Command request identifier. See Table 8-19.
<Receiver ID>	Receiver ID number. 1 or 2 ASCII digits.
<\$22>	Separator
<LC#>	The line card number.
<V-byte>	Validation Byte (V-byte). See 8.7.5.
<\$0D>	End of message indicator.

### 8.7.7.3 Add or Delete a Listen-in Account

If the account number of a control panel is in the listen-in account list, when that control panel calls in to the receiver, the receiver will perform a listen-in operation with that control panel. The maximum length of a listen-in account number is 8 characters and may include wild card characters (# and or \*). Each line card can have up to 20 listen-in accounts. See also Section 5.4.2.3.

#### To Add a Listen-in Account:

<\$04><Receiver ID><\$22><LC#><\$22><Act#><V-byte><\$0D>

**Table 8-23: Add Listen-in Account Request Components**

Component	Description
<\$04>	Command request identifier. See Table 8-19.
<Receiver ID>	Receiver ID number. 1 or 2 ASCII digits.
<\$22>	Separator
<LC#>	The line card number.
<\$22>	Separator
<Act#>	Account number to be added to the listen-in account list.
<V-byte>	Validation Byte (V-byte). See 8.7.5.
<\$0D>	End of message indicator.

#### To Delete a Listen-in Account:

<\$03><Receiver ID><\$22><LC#><\$22><Act#><V-byte><\$0D>

**Table 8-24: Delete a Listen-in Account Request Components**

Component	Description
<\$03>	Command request identifier. See Table 8-19.
<Receiver ID>	Receiver ID number. 1 or 2 ASCII digits.
<\$22>	Separator
<LC#>	The line card number.
<\$22>	Separator
<Act#>	Account number to be deleted from the listen-in account list.
<V-byte>	Validation Byte (V-byte). See 8.7.5.
<\$0D>	End of message indicator.

### 8.7.7.4 Common Listen-in Extend/End Request

During a listen-in operation if the call requires additional time you can extend the listen-in period by sending an extend request. At the end of a listen-in call you can end the session by sending an end request.

Some control panels send a listen-in period included in the reported message to the receiver. If the listen-in period is not sent from the control panel, the programmed listen-in period will be used. See Section 5.4.2.3.

#### To Extend Listen-in:

<\$4C><Receiver ID><\$22><LC#><V-byte><\$0D>

**Table 8-25: Extend Listen-in Period Request Components**

Component	Description
<\$4C>	Command request identifier. See Table 8-19.
<Receiver ID>	Receiver ID number. 1 or 2 ASCII digits.
<\$22>	Separator
<LC#>	The line card number.
<V-byte>	Validation Byte (V-byte). See 8.7.5.
<\$0D>	End of message indicator.

#### To End a Listen-in Session:

<\$48><Receiver ID><\$22><LC#><V-byte><\$0D>

**Table 8-26: Extend Listen-in Period Request Components**

Component	Description
<\$48>	Command request identifier. See Table 8-19.
<Receiver ID>	Receiver ID number. 1 or 2 ASCII digits.
<\$22>	Separator
<LC#>	The line card number.
<V-byte>	Validation Byte (V-byte). See 8.7.5.
<\$0D>	End of message indicator.



### 8.7.7.5 PBX Listen-in String

When PBX listen-in mode is selected (see Section 5.4.2.3), the receiver will transfer the call to the extension X string. The PBX string can also be programmed in to the receiver from the automation computer.

#### To Create or Edit PBX String:

<\$49><Receiver ID><\$22><LC#><\$22><PBX String><V-byte><\$0D>

**Table 8-27: Delete a Listen-in Account Request Components**

Component	Description
<\$49>	Command request identifier. See Table 8-19.
<Receiver ID>	Receiver ID number. 1 or 2 ASCII digits.
<\$22>	Separator
<LC#>	The line card number.
<\$22>	Separator
<PBX String>	PBX string to transfer a call to a specified extension. See Table 5-12 for valid string characters.
<V-byte>	Validation Byte (V-byte). See 8.7.5.
<\$0D>	End of message indicator.

### 8.7.7.6 Add or Delete a Trap Account

The receiver provides a trapping feature that allows the automation computer to trap certain account numbers when these account numbers are identified in the trap account list. Trapping is typically done to panels that are to be sent to an up-load/down-load computer for programming.

#### To Add a Trap Account:

<\$02><Receiver ID><\$22><LC#><\$22><Act#><V-byte><\$0D>

**Table 8-28: Add Listen-in Account Request Components**

Component	Description
<\$02>	Command request identifier. See Table 8-19.
<Receiver ID>	Receiver ID number. 1 or 2 ASCII digits.
<\$22>	Separator
<LC#>	The line card number.
<\$22>	Separator
<Act#>	Trap account number to be added to the trap account list.
<V-byte>	Validation Byte (V-byte). See 8.7.5.
<\$0D>	End of message indicator.

#### To Delete a Trap Account:

<\$01><Receiver ID><\$22><LC#><\$22><Act#><V-byte><\$0D>

**Table 8-29: Delete a Listen-in Account Request Components**

Component	Description
<\$01>	Command request identifier. See Table 8-19.
<Receiver ID>	Receiver ID number. 1 or 2 ASCII digits.
<\$22>	Separator
<LC#>	The line card number.
<\$22>	Separator
<Act#>	Trap account number to be deleted from the trap account list.
<V-byte>	Validation Byte (V-byte). See 8.7.5.
<\$0D>	End of message indicator.

### 8.7.7.7 Link Test Request

The automation computer can send a link test request to the 9800 receiver to test the communication link between the receiver and the automation computer. The automation computer simply sends a <\$0D> and the 9800 receiver will respond.

## 8.8 US ASCII Character Code

The following table displays the US ASCII character its hexadecimal code equivalent.

**Table 8-30: US ASCII Character Code**

Character	Hex	Character	Hex	Character	Hex	Character	Hex	Character	Hex
NUL	00	DC4	14	(	28	<	3C	Q/q	51/71
SOH	01	NACK	15	)	29	=	3D	R/r	52/72
STX	02	SYN	16	*	2A	>	3E	S/s	53/73
ETX	03	ETB	17	+	2B	?	3F	T/t	54/74
EOT	04	CAN	18	'	2C	@	40	U/u	55/75
ENQ	05	EM	19	-	2D	A/a	41/61	V/v	56/76
ACK	06	SUB	1A	.	2E	B/b	42/62	W/w	57/77
BEL	07	ESC	1B	/	2F	C/c	43/63	X/x	58/78
BS	08	FS	1C	0	30	D/d	44/64	Y/y	59/79
HT	09	GS	1D	1	31	E/e	45/65	Z/z	5A/7A
LF	0A	RS	1E	2	32	F/f	46/66	[	5B
VT	0B	US	1F	3	33	G/g	47/67	\	5C
FF	0C	SPACE	20	4	34	H/h	48/68	]	5D
CR	0D	!	21	5	35	I/i	49/69	/	5E
S0	0E	“	22	6	36	J/j	4A/6A	—	5F
S1	0F	#	23	7	37	K/k	4B/6B	‘	60
DLE	10	\$	24	8	38	L/l	4C/6C	{	7B
DC1	11	%	25	9	39	M/m	4D/6D		7C
DC2	12	&	26	:	3A	N/n	4E/6E	}	7D
DC3	13	‘	27	;	3B	O/o	4F/6F	~	7E
						P/p	50/70	DEL	7F



# Appendix A

## Programming Quick Chart

151018

Table A-1: Programming Quick Chart

Program Mode Options	Choices	Choices	Choices	Choices	Comments		
General Options	Operation Mode	Manual			See Section 4.5 for description of modes of operation. See also Section 5.3.1.		
		Automatic					
		Log Only					
	Display Options	Language	English			See Section 5.3.2 for details.	
			español			Not available at this time.	
		Time Format	AMPM			12 hour clock. See Section 5.3.2.2 for details.	
			24Hr			24 hour clock. See Section 5.3.2.2 for details.	
		Date Format	M\D\Y			See Section 5.3.2.3 for details. M = month, D = day, Y = year.	
			D·M·Y				
			Y-M-D				
		Day light Savings	Yes			See Section 5.3.2.4 for details.	
			No				
		ITI Options	Attempts	Yes or No			See Section 5.3.2.5
			CPU Time	Yes or No			Affects printer and LCD output only.
			CPU Type	Yes or No			
			Panel Rev	Yes or No			
			Arming Level	Yes or No			
	Sorted Events	Yes			Sorted. See Section 5.3.2.6 for details.		
		No			Non-sorted		
	Hold last event	Yes			See Section 5.3.2.7.		
No							
Communication	Port Functions	Com1	Unused/Automation/Printer/	Rules for Port Configuration: 1. Functions in Brackets [ ] will not appear unless “Automation” is selected for Com1 function. 2. Functions in { } will not appear unless “Printer” is selected in Com1 or Par. 3. A function may be selected only once in the 3 ports (only one printer, only one Diag, and so on). 4. All ports may be configured “Unused”.			
		Com2	Unused/[Auto Bkp]/[Auto Bkp Prn]/{Print Bkp}/Diag/Printer				
		Par (Parallel)	Unused/[Auto Bkp]/Printer/Diag				

A-1

**Table A-1: Programming Quick Chart**

Program Mode Options	Choices	Choices	Choices	Choices	Comments
General Options (Continued)	Communications (Continued)	Com Port1	Baud	19200, 9600, 7200,4800, 2400, 1200, 600, 300, 110	See Section 5.3.3.2 for details.
			D (# Data Bits)	8, 7	
			S (# Stop bits)	1 or 2	
			P (Parity)	Even, Odd, No, Space, Mark,	
			F (Flow Control)	Hdwr, None	
			Init Str (Initialization String)		
		Com Port2	Same as Com1		
		Par Port	Edit Init String		Enter or edit an Escape command sequence. For example: Set the page size or number of lines per page for a printer.
		Automation Cfg.	Format	SIA CIS, SK 9000, ITI Gen, ITIComp, SK EXP, SIA2000	See Section 5.3.3.5 for details.  This feature is only available if SK 9000 automation protocol is selected.
			Hex	Y (yes) N (no)	
			Heartbeat	Y (yes) N (no)	
			Time (of heartbeat)	10-600 seconds	
			Ack timeout	10-600 seconds	
		Annunciator Configuration	Printer	Yes or No	See Section 5.3.3.6 for details.
			Bkp Printer	Yes or No	Yes = alert on trouble indication
			Auto Comp	Yes or No	See Section 2.3.2 for UL requirements on listen-in.
			Bkp Auto Comp	Yes or No	
			MeterMinder	Yes or No	
			Battery	Yes or No	
			Line Card	Yes or No	
			Line Fault	Yes or No	
AC Power	Yes or No				
Buffer Full	Yes or No				
Listen In	Yes or No				
Call Pending	Yes or No				

A-2

151018

**Table A-1: Programming Quick Chart**

Program Mode Options	Choices	Choices	Choices	Choices	Comments
General Options (Continued)	Communications (Continued)	Aux Relay Cfg	Printer	Yes or No	See Section 5.3.3.7 for details. Yes = alert on trouble indication See Section 2.3.2 for UL requirements on listen-in.
			Bkp Printer	Yes or No	
			Auto Comp	Yes or No	
			Bkp Auto Comp	Yes or No	
			MeterMinder	Yes or No	
			Battery	Yes or No	
			Line Card	Yes or No	
			Line Fault	Yes or No	
			AC Power	Yes or No	
			Buffer Full	Yes or No	
			Listen In	Yes or No	
			Call Pending	Yes or No	
	System Options	Battery Backup Cfg	No Battery Bkp		See Section 5.3.4.1 for details.
			Battery Bkp		See Section 5.3.4.1 for details.
			DC Bkp		No charging current. See Section 5.3.4.1 for details.
		Receiver ID	01-99		See Section 5.3.4.2 for details.
		Auxiliary Relay	DeEnergize		See Section 5.3.4.3 for details.
			Energize		
	Message Queue Opt.	Wrn Lvl	On: 10 to 99%	75%	Set the percentage of how full the message queue must be before a "Message Queue Warning" will occur.
			Off: 01 to 90 %	50%	What percentage the queue must go back down to before "Message Queue Warning Restore" message will be sent.
Max Buf Limit		500 to 5000	1000	Used to set the maximum number of bytes in a call. This number is used to determine if a call is a runaway call.	
Line Card Menu	Add Line Card	Line Card #	Use Defaults		See Section 5.4.1 for details.
			Copy Existing		
	Edit Line card	Handshake Sequence	Handshake Sequence	1 through 6	See Section 5.4.2.1 for details.
			Handshake Group	See Section 5.4.2.	
			Handshake Delay	0-255 in 50ms periods	
			Handshake Duration	0-255 in 10ms periods	
			Handshake Wait	0-255 in 50ms periods	
			Handshake Ack Duration	0-255 in 10ms periods	

151018

A-3

**Table A-1: Programming Quick Chart**

Program Mode Options	Choices	Choices	Choices	Choices	Comments	
Line Card Menu (Continued)	Edit Line Card (Continued)	Line Options	Direct	Y (yes) N (no)	Y = dedicated or direct connect phone line. N = used for standard phone lines.	
			Number of Rings	0-255	See Section 5.4.2.2 for details.	
			On Time	0-255 in 50ms periods		
			Off Time	0-255 in 50ms periods		
			Threshold	0-15 in 1.64 VDC steps		
			Sample Time	0-255 seconds.		
		Listen In	Listen In Mode	Common, PBX, Not Used	See Section 5.4.2.3 for details.	
			PBX string edit screen	Up to 20 characters.	See Section 2.3.2 for UL requirements on listen-in.	
			Timeout	0-255 seconds?		
			Listen In account edit screen	Add, Edit, or Clear Account (up to 20 accounts).		
		Trap List	Add Account	Up to 20 accounts.	See Section 5.4.2.4 for details.	
			Edit Account			
			Clear Account	Highlight with equal sign and press enter.		
		Misc. Line Options	Echo Supress	Y (yes) N (no)	See Section 5.4.2.5 for details.	
				Caller ID		Y (yes) N (no)
			Billing Delay			On Off
			Hunt Group	00-99		
			ITI 300 Baud	Y (yes) N (no)		
		ITI Sec. Code	5 digits	12345 default.	Used for ITI panels with Central Station Lock initialized.	
		Copy Line Card(s)	Use Defaults	Choose Line card(s) #		Choose Line card(s) # that you wish to be programmed to factory defaults.
			Copy Existing	Choose Line card # of Source Line Card	Choose the target line card(s) #.	Copy the programming of one line card (source) and paste it into one or several (target) line cards.
		Clear Line Card	Line Card #			See Section 5.4.4 for details.
		View Line Cards	Line Card #			See Section 5.4.5 for details.

A-4

151018



Table A-1: Programming Quick Chart

Program Mode Options	Choices	Choices	Choices	Choices	Comments
User List	Add User	User Name	Up to 16 characters.		See Section 5.5 for details.
		User Code	4-9 digits		
		User Profile	Installer/Operator		
	Edit User	List of users	User name, code and profile		
	Clear User	List of users			



---

---

# Index

---

---

## Numerics

230 VAC .....	3-10
25-Pin Null Modem Cable .....	3-14
9-Pin Null Modem Cable .....	3-14

## A

Accessories .....	1-2
ACKing .....	8-7, 8-16, 8-23, 8-43
Acknowledge Time .....	5-24
Acknowledgment Tone Duration Time .....	5-42
Annunciator .....	5-16
ASCII .....	8-51
Automatic .....	5-7
Automation .....	5-16, 8-1, 8-44
Automation Communication Format .....	5-21
Aux Relay .....	5-17, 5-29
Auxiliary Relay .....	3-1, 5-28, 5-31

## B

Backup Battery .....	5-30
Bad Data .....	8-5, 8-39
Battery Backup .....	5-29

## C

Call Message .....	8-33
Caller ID .....	5-36, 5-44, 5-54
Calls From Panels .....	8-4
checksum/controlfield .....	8-31
Com Port 1 .....	3-14, 5-14, 5-15, 5-18
Com Port 2 .....	5-14, 5-15, 5-19
communication option .....	5-14
Computer Interface Standard .....	8-9
computer port baud rate .....	3-14
Condition Codes .....	8-29
Configure Printer .....	4-23

## D

Data String .....	8-2
Date Display .....	5-9
Date Format Display .....	5-11
Day Light Savings .....	5-9, 5-11
Dedicated Line .....	5-43
default settings .....	1-5
Default User Codes .....	4-8

delete a user .....	5-67
Direct Line .....	5-43
Display options .....	5-9
<b>E</b>	
earth ground .....	3-12
Enter Program Mode .....	5-1
<b>F</b>	
FCC .....	2-1
FCC Registration Number .....	2-1
Features .....	1-1
firmware information .....	4-14
Format Group .....	5-40
Formats .....	1-3
Fuse .....	3-1
<b>G</b>	
General Options .....	5-3
General Options Items .....	5-4
Grounding .....	3-12
<b>H</b>	
Handshake Delay .....	5-41
Handshake Duration .....	5-41
Handshake Sequence .....	5-39, 5-40
Handshake Wait .....	5-42
Hang Up .....	8-9, 8-46
Header Block .....	8-32
Heart beat .....	8-15
Heartbeat .....	5-22, 5-23, 8-42
hexadecimal values .....	8-1
Hold Last Event .....	5-10, 5-13
<b>I</b>	
Initialization string (Init string) .....	5-20
ITI Computer Interface format .....	5-25, 8-24
ITI Formats .....	5-26
ITI Generic .....	5-25, 8-18, 8-20
ITI Panels .....	5-26
ITI Security Code .....	5-57
<b>L</b>	
Language .....	5-9
Language Display .....	5-10
LCD .....	4-3
LCD Contrast .....	4-4
LED .....	4-3
Line card .....	5-33, 5-37

Line Options .....	5-43
Line Voltage .....	3-1
Link Test .....	8-17, 8-51
Listen-in .....	4-28, 8-9, 8-37, 8-47, 8-48, 8-49
log off .....	4-9, 8-45
log on .....	4-8, 8-45
Log only operation .....	5-7
Log Record .....	5-26, 8-30
Long Call .....	8-38
Long Calls .....	8-5, 8-13
<b>M</b>	
Main Menu .....	4-11
Main Menu Option Items by Profile .....	4-7
Maneuver Around in Program Mode .....	5-2
Maneuver Through Main Menu .....	4-12
Manual (Common) Listen-In .....	4-28
Manual operation .....	5-7
Message Format .....	8-11
model number .....	4-14
Modifier Codes .....	8-12
<b>N</b>	
NACKing .....	8-7, 8-16, 8-23, 8-43
Normal mode .....	4-10
<b>O</b>	
Okay Record .....	8-23
On-board Annunciator .....	5-27
Operation mode .....	5-7, 5-8
<b>P</b>	
Panel data .....	8-35
Panel Type Characters .....	8-28
Parallel Port .....	5-15
PBX .....	8-49
PBX String .....	8-49
PBX string .....	4-29
Phone Line Sample Rate .....	5-46
PIN .....	1-5, 4-8, 5-63, 5-65, 5-66
Port function .....	5-14, 5-15, 5-18
Power Up .....	4-6
Print a Test Page .....	4-21
Print Call History .....	4-18
print menu .....	4-17
Print Report .....	4-18
Print System Configuration .....	4-20
Print System History .....	4-19

printer cable .....	3-8
Program Menu .....	4-24
Programming .....	5-1
Programming Choices .....	5-2
Programming Fields .....	5-1
<b>R</b>	
Receiver ID .....	4-14, 5-29, 5-30
Record Structure .....	8-24
Report Record .....	8-25
Ring Off Time .....	5-45
Ring On Time .....	5-44
Ring Threshold Voltage .....	5-45
Rings .....	5-44
<b>S</b>	
Set Time & Date .....	4-15
Silent Knight Expanded format .....	8-32, 8-34
SK EXP .....	8-32
software date code .....	4-14
software revision .....	4-14
Sorted Event .....	5-10, 5-13
Supervisory Character .....	5-26
System History .....	4-13
System Info .....	4-14
System Message .....	8-39
System Messages .....	8-6, 8-41
System Options .....	5-29
System Status Messages .....	8-14
<b>T</b>	
Test Record .....	8-18, 8-22, 8-29
Testing .....	4-29
Threshold .....	5-45
Time Display .....	5-9
Time Format Display .....	5-10
Touchpad Buttons .....	4-2
Trap Account .....	8-38, 8-50
<b>U</b>	
User List .....	5-63
<b>V</b>	
V-Byte .....	8-6, 8-42

**IMPORTANT:** Silent Knight products should be tested weekly to insure complete and proper operation and proper input and output connections.

### **LIMITED WARRANTY**

Silent Knight warrants that the central station receiver products of its manufacture shall be free from defects in materials or workmanship for five years from the date on the date code label, located on the printed circuit board, if such goods have been properly installed, are subject to normal proper use, and have not been modified in any manner whatsoever. Upon return of the defective product to Silent Knight, Silent Knight will, at its sole discretion, either repair or replace, at no cost, such goods as may be of defective material or workmanship. Customers outside the United States are to return products to their distributor for repair.

SILENT KNIGHT SHALL NOT UNDER ANY CIRCUMSTANCES BE LIABLE FOR ANY INCIDENTAL OR CONSEQUENTIAL DAMAGES ARISING FROM LOSS OF PROPERTY OR OTHER DAMAGE OR LOSSES OWING TO THE FAILURE OF SILENT KNIGHT SECURITY SYSTEMS PRODUCTS BEYOND THE COST OF REPAIR OR REPLACEMENT OF ANY DEFECTIVE PRODUCTS.

SILENT KNIGHT MAKES NO WARRANTY OF FITNESS OR MERCHANTABILITY AND NO OTHER WARRANTY, ORAL OR WRITTEN, EXPRESS OR IMPLIED, BEYOND THE FIVE YEAR WARRANTY EXPRESSLY SPECIFIED HEREIN.

