

R A D I O N I C S

Easikey 1000 / 1000 Plus

Installation and Programming Manual

Notices

Notice

The material and instructions in this manual have been carefully checked for accuracy and are presumed to be reliable. However, Radionics, Inc. assumes no responsibility for inaccuracies and reserves the right to modify and revise this manual without notice.

It is our goal at Radionics to always supply accurate and reliable documentation. If a discrepancy is found in this documentation, please mail a photocopy of the corrected material to:

Radionics, Inc.
Technical Writing Department
1800 Abbott Street
Salinas, California 93901

Warranty

This product is covered under the five-year limited warranty described in Radionics "Standard Terms and Conditions" in the *Radionics Product Catalog* (L100).

FCC Notice

This equipment has been tested and found to comply with the limits for a Class B digital device, pursuant to part 15 of the FCC Rules. These limits are designed to provide reasonable protection against harmful interference in a residential installation. This equipment generates, uses and can radiate radio frequency energy and, if not installed and used in accordance with the instructions, may cause harmful interference to radio communications. However, there is no guarantee that interference will not occur in a particular installation. If this equipment does cause harmful interference to radio or television reception, which can be determined by turning the equipment off and on, the user is encouraged to try to correct the interference by one or more of the following measures:

- 1) Reorient or relocate the receiving antenna
- 2) Increase the separation between the equipment and receiver.
- 3) Connect the equipment into an outlet on a circuit different from that to which the receiver is connected.
- 4) Consult the dealer or an experienced radio/TV technician for help.

Table of Contents

NOTICES	I
NOTICE.....	I
WARRANTY	I
FCC NOTICE	I
TABLE OF CONTENTS.....	II
THE EASIKEY 1000/1000 PLUS.....	1
OVERVIEW.....	1
SYSTEM FEATURES.....	1
<i>Access Points</i>	1
<i>Lock Outputs</i>	1
<i>Personnel</i>	1
<i>Time Profiles</i>	1
<i>Door Monitoring Alarms (Easikey 1000 Plus Only)</i>	2
<i>Printer Facilities</i>	2
SYSTEM OPERATION.....	2
INSTALLING THE SYSTEM.....	3
EASIKEY 1000/1000 PLUS	3
CHOOSING THE BEST LOCATION FOR THE EK1000	4
INSTALLING THE POWER SUPPLY	4
<i>Choosing the Stand-by Battery and Low Battery Indicator</i>	4
INSTALLING AN OPTIONAL PRINTER.....	5
<i>Printer Specifications</i>	5
<i>Printer Cable</i>	6
USING EXTERNAL READERS FOR SYSTEM ADMINISTRATION.....	6
<i>Connecting External Readers</i>	6
<i>Using Wiegand Device Readers</i>	7
INSTALLING READERS AND CONNECTING LOCK OUTPUTS.....	7
<i>Readers</i>	7
<i>Wiring Considerations for All Readers</i>	7
<i>Reader Connections</i>	7
<i>Wiegand Reader Wiring</i>	8
MOUNTING THE READER	9
<i>Request to Exit</i>	9
ALARM EVENT MONITORING (EASIKEY 1000 PLUS ONLY).....	9
DOOR CONTACT MONITORING (EASIKEY 1000 PLUS ONLY).....	10
<i>Connecting the Door Contact</i>	10
READER TAMPER DETECTION (EASIKEY 1000 PLUS ONLY).....	10
<i>Lock Outputs</i>	10
<i>Fire Escape Safety</i>	11
ALARM OUTPUT RELAY (EASIKEY 1000 PLUS ONLY)	11
FREE EXIT AND EMERGENCY OVERRIDE OPTION	12
OPERATING THE SYSTEM.....	13
OVERVIEW OF SYSTEM ADMINISTRATION	13

<i>Using the Editor Key/Cards</i>	13
Master Editor Key/Card	13
Sub Editor Key/Cards.....	13
Editor Time-out.....	13
HOW TO USE THE EK1000 KEYPAD AND EDITOR MODE	14
USING THE KEYPAD	14
<i>Entering Data</i>	14
SYSTEM DISPLAYS AND ALARMS.....	15
<i>Power Indicators</i>	15
<i>Normal Displays</i>	15
DOOR LEFT OPEN WARNING (EASIKEY 1000 PLUS ONLY)	16
<i>Unauthorized Access Alarm (Easikey 1000 Plus Only)</i>	16
<i>Cable or Reader Tamper Alarm (Easikey 1000 Plus Only)</i>	17
<i>Alarm Relay Response (Easikey 1000 Plus Only)</i>	17
PROGRAMMING THE SYSTEM.....	18
APPLYING POWER	18
<i>Installing the Master Editor Key/Card</i>	18
<i>Testing the Master Editor Key/Card and System</i>	19
INSTALLING AND VOIDING ADDITIONAL SUB EDITOR KEY/CARDS.....	20
<i>Adding a Sub Editor Key/Card</i>	20
<i>Voiding an Sub Editor Key/Card</i>	21
<i>Setting the Clock</i>	22
TIME PROFILES AND TIME PERIODS.....	23
<i>Overview of Time Profiles</i>	23
<i>Time Profiles for Doors</i>	23
<i>Time Profiles for User Keys</i>	23
<i>When Time Profiles Actually Begin and End</i>	23
<i>Time periods Do Not Cross Midnight</i>	23
<i>24-Hour Operation</i>	24
<i>Programming and Editing Time Profiles</i>	24
PROGRAMMING THE DOOR DATA.....	28
<i>Lock Release Time</i>	28
<i>Door Open Time (Easikey 1000 Plus Systems Only)</i>	28
<i>Door Time Profile</i>	28
<i>Door Options</i>	28
1 Lock Mode	28
2 Free Exit/Emergency Override	29
3 RTE Report	29
4 Not Used - Leave UNSET	29
5 Set/Reset	29
USING THE DOORS FUNCTION.....	30
<i>Channel Interlock</i>	31
<i>Programming Channel Interlock</i>	31
<i>Anti-Passback</i>	31
<i>Programming Anit-Passback</i>	32
MANUAL LOCK/UNLOCK FOR CONTROLLING THE DOORS	32
<i>Doors controlled by a Time Profile</i>	32
<i>Doors not controlled by a Time Profile</i>	32
<i>To Lock/Unlock a Door</i>	33
ACCESS LEVELS & TIME PROFILES	33
<i>Access Levels</i>	33

USER (KEY/CARD) NUMBERS.....	34
ADDING OR EDITING USERS.....	34
<i>Adding Several Keys</i>	36
<i>Editing a Key/Card</i>	36
<i>Displaying a Key/Card PIN Number</i>	37
<i>Identifying a Key/Card</i>	38
<i>Voiding Key/Cards (Users) from the EK1000</i>	38
ADDITIONAL SYSTEM OPTIONS.....	39
<i>Software Version Display</i>	39
<i>Upload/Download Option</i>	40
<i>Display Last Five Keys or Cards Used</i>	41
TRANSACTION LOGGING.....	41
<i>Sample transaction printout</i>	41
TRANSACTION EVENT DEFINITIONS.....	42
<i>Normal Entry and Exit</i>	42
<i>Alarms and Warnings</i>	42
<i>No Access</i>	43
<i>Door Events</i>	43
<i>Other Events</i>	43
PRINTING REPORTS.....	44
<i>User Selected Reports</i>	44
<i>To Print the Database</i>	44
Sample database printout.....	45
<i>Printing Selected Key/card Transactions</i>	46
<i>Clearing the Transaction Database</i>	46
GLOSSARY	47
SPECIFICATIONS.....	49
POWER INPUT	49
POWER OUTPUT	49
ENVIRONMENTAL.....	49
DOORS.....	49
USERS	49
TRANSACTION BUFFER.....	49
PRINTER OUTPUT	49
TIME PROFILES	49
ENCLOSURES	49
EK1000 PLUS	49
NOTES.....	50

THE EASIKEY 1000/1000 PLUS

Overview

The Easikey 1000 is a two door access control system using Radionics' Easikey/Readykey proximity key/card technology. The complete system includes a EK1000 with a numeric keypad and display, one or two readers located at the controlled doors and a number of Easikey electronic keys or cards. See the *Radionics Product Catalog(L100)* for a list of components and accessories suitable for use with the Radionics Easikey 1000.

System Features

Access Points

The Easikey 1000 controls one or two doors, each of which may be up to 300ft/100m away from the controller. You may install the following types of readers with the EK1000. See *Radionics Product Catalog(L100)* for a list of components and accessories suitable for use with the Radionics Easikey 1000.

- Easikey proximity readers
- Readykey proximity readers
- Readykey PIN readers
- Wiegand 26-bit reader with an Easikey EK12 Wiegand Interface

The EK1000 also provides an input for Request to Exit switches, allowing users to exit through a lock-controlled door from the secured side.

Lock Outputs

The Easikey 1000 door controller supplies 12 VDC at 1 Amp current for powering either fail-safe (power to lock) or fail-secure (power to unlock) locks.

Personnel

The EK1000 can store up to 1000 individual users in its memory. The system administrator can cause the EK1000 to allow each key/card to enter through both doors, either door, or neither door. The system administrator can assign each user a Time Profile to restrict access to certain days and times.

Time Profiles

The system administrator can create up to eight Time Profiles; each containing up to three Time Periods. The administrator can assign Time Profiles to doors and users. For example, the administrator can program the door to open between 9:00 a.m. and 5:00 p.m., Monday through Friday, but require users to present a key/card all other days and times. Similarly, the administrator can assign a Time Profile to a user's key/card that only allows the user to use the key/card on certain days and at certain times.

Door Monitoring Alarms (Easikey 1000 Plus Only)

Easikey 1000 Plus systems can monitor door contact switches. This enables Easikey 1000 Plus systems to generate the following types of alarms:

- **Unauthorized Access Alarms**
The EK1000 creates this alarm when someone opens a door without using a valid key/card, or without activating the Request to Exit device.
- **Door Left Open Warnings**
The EK1000 creates this condition when something causes the door to stay open longer than the time programmed in the Door Open Time option.

Printer Facilities

The Easikey 1000 has a built-in printer interface. If you connect a printer to the EK1000, the system can print each event as it happens, or store up to 1000 events for printing on demand. The system can print database information including users, Time Profiles and door information, and the movements of individual users in selected reports.

System Operation

This manual describes installations using proximity key/cards: The information provided in this manual assumes that you are using Radionics' Easikey or Readykey proximity keys or cards with the system.

The system operates when a user presents an Easikey key/card close to an Easikey door reader. The key or card transfers its unique serial number to the reader. The reader transfers the key's or card's serial number to the EK1000 door controller. When the EK1000 receives the serial number, it checks the following items before allowing access to the secured area:

1. Is the key/card's serial number one that has been stored into the EK1000's database?
2. Is the user assigned to this key/card allowed through this door?
3. Is the user assigned to this key/card allowed to enter through this door at this time and on this day?

If the answer to all three questions is "Yes", the EK1000 will enable its lock output used to activate an electric locking mechanism for a programmed number of seconds, allowing the key/card holder to pass through the door.

Installers often place a button or switch on the secure side of the door called the Request to Exit switch. The Request to Exit switch allows anyone to leave the secured area without using their key/card. This is also sometimes referred to as an "Egress" input.

INSTALLING THE SYSTEM

Identifying which version of EK1000 door controller you are installing: You can identify the difference between the Easikey 1000 or the Easikey 1000 Plus by the front keypad label. The label is marked Easikey 1000 Plus.

Easikey 1000/1000 Plus

The Easikey 1000 requires an enclosure and a power source.

Radionics has two types of enclosures that you can use with the EK1000. There are also packages available that include an enclosure.

The two types of enclosures used for the EK1000 are:

- D7103** The Easikey 1000 mounts directly into the D7103 enclosure. There is also space for a power supply and a single 12 VDC 7Ah battery.
- D8103** The Easikey 1000 mounts into a D8103 enclosure using a D7102 Mounting Skirt. The D8103 has space for a power supply and two 12 VDC 7Ah batteries.

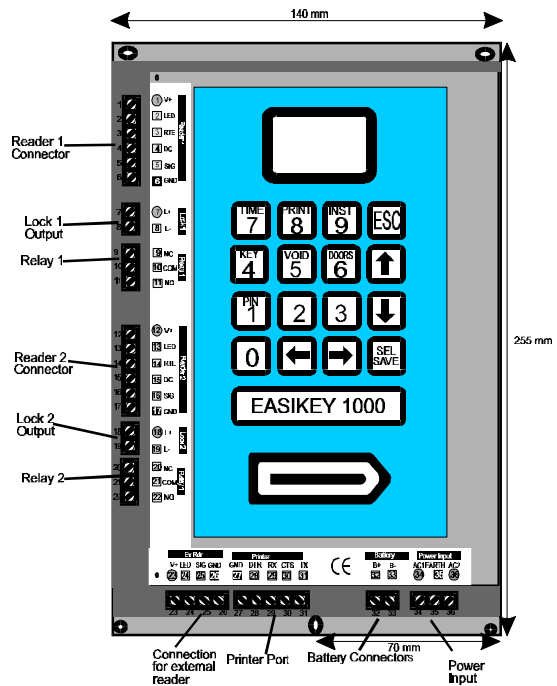

Figure 1: Easikey 1000 Door Controller

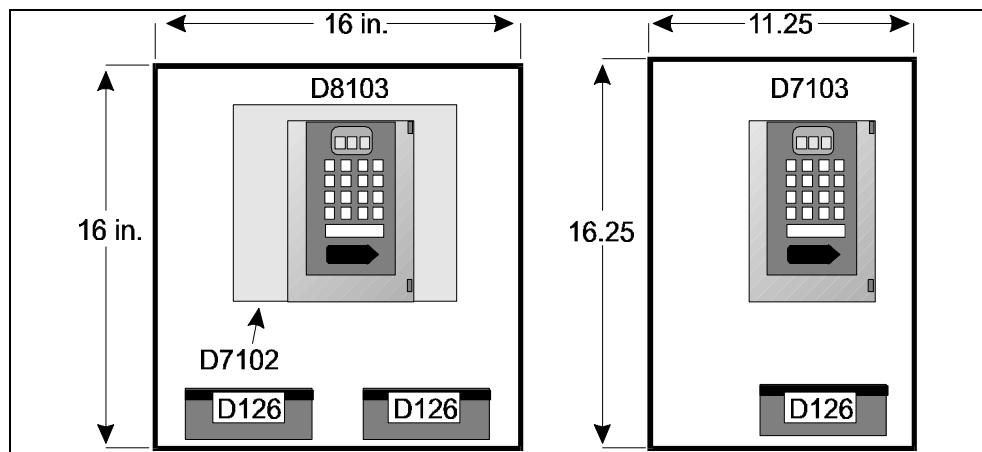

Figure 2: Easikey 1000 in the Enclosures

Choosing the Best Location for the EK1000

Mount the controller in a secure but accessible location. System administrators will program the system at the EK1000, so proper mounting of the EK1000 door controller will allow the display to be easily viewed by the system administrators.

Installing the Power Supply

The Easikey 1000 requires one of the three types of power sources shown below:

- A 12 VDC 3 Amp power supply.
- A 24 VDC 1.5 Amp power supply.
- A 16.5V AC power source at a minimum 40VA rating. Radionics offers the D1640 transformer that supplies 16.5 VAC @ 40VA.

AC Power LED OFF in Editor Mode: When the AC power supply is providing power to the controller, the red LED on the controller illuminates, except when the controller is in the Editor's Mode. If you are using a 12 VDC power source the red LED will not illuminate even though power is supplied to the EK1000.

The EK1000 door controller and two Easikey readers require 600mA. In addition, the power supply must provide power for locks you attach to the EK1000. Each lock output can supply up to 1 Amp continuously at 12 VDC. Therefore, choose a power supply capable of providing between 2.6 Amps and 3 Amps total, depending on the current consumption of the locks.

The database is preserved when power is completely lost: The controller stores the database in battery-backed memory. If AC and battery power are both disconnected from the EK1000, the EK1000 preserves the information in the database. The database is preserved for up to 12 months when the EK1000 is not powered. An internal NICAD battery is charged as long as the EK1000 is powered. If the NICAD battery discharges during a power failure, it recharges when power returns to the EK1000. Installers or users cannot replace the internal NICAD battery. The NICAD battery must be replaced at the factory.

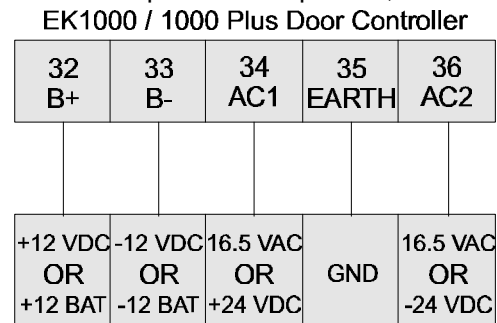

Power Sources

Figure 3: Connecting the power source and battery to the EK1000

Figure 3 shows where to connect the power source being used to the EK1000 door controller.

Choosing the Stand-by Battery and Low Battery Indicator

Before choosing the battery to the power supply, calculate the battery's capacity requirement based on:

- The current consumption of the EK1000 and Easikey readers (up to 600mA).
- The current consumption of the locks when operating normally (up to 1 Amp)

each).

- The type of lock (fail-safe or fail-secure).
- The length of time the system should operate without AC power to the EK1000 or power supply.

Example: An Easikey 1000 with two Easikey readers and two 300mA fail-safe locks will continuously draw about 1.2 Amps. Using a 7Ah battery (one D126) will provide approximately 5.9 hours standby time. A 14Ah battery (two D126s) provides approximately 16.5 hours standby time.

After determining the standby requirement for the battery, place the batteries on the bottom of the enclosure and connect them to the battery terminals (see Figure 3).

Battery LED OFF in Editor Mode: When battery power falls below 12 VDC, the green LED on the EK1000 illuminates. The green LED extinguishes when the battery voltage recharges above 12 VDC or while the EK1000 is in the Editor Mode.

Installing an Optional Printer

Printer Specifications

An 80-column dot matrix printer with a serial interface is required. Use switches or jumpers on the printer to set the printer to the following parameters:

- 4800 baud
- 8 data bits, 2 stop bits
- No parity
- Hardware handshake using DTR/CTS. When the printer is busy, then it should force DTR low.

Radionics has used the EPSON LX series and the OKI Microline printers with their serial board in the past.

Printer Cable

Connecting a printer to the EK1000 requires the following cable:

Use 22ga., signal cable, maximum length 30ft/15m

Easikey 1000 Five-way Terminal Block		Printer 25-pin male D-type connector
TX	-----	3 RX
CTS	-----	20 DTR
RX		not used
DTR	-----	5 CTS
GND	-----	7 Signal Ground

Table 1: Connecting a Printer

Using External Readers for System Administration

Connecting External Readers

If you are using an alternate reader technology with the system, you can attach an external Wiegand 26-bit reader with the EK12 Wiegand Interface. This allows the system administrator to add, or identify the alternate ID devices with the controller. If you use the EK12 Wiegand Interface, connect it to the EK1000 at the terminal connectors 23-26 located on the bottom left edge of the EK1000.

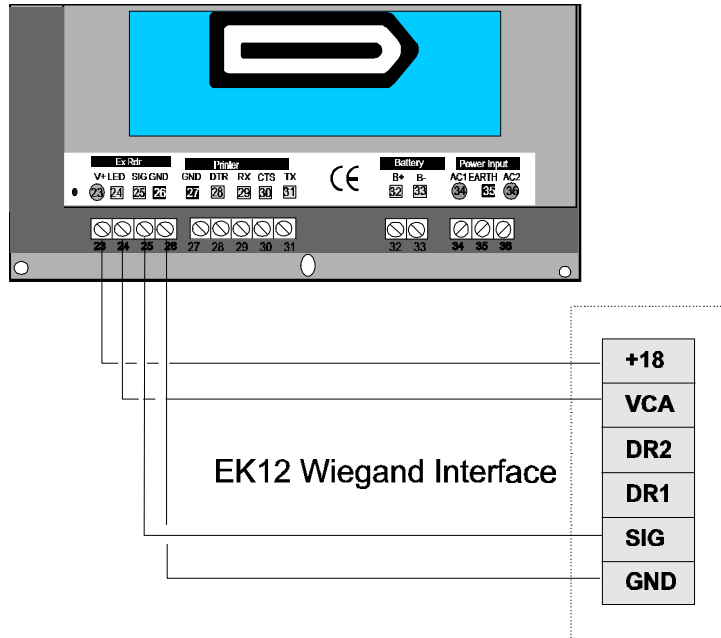

Figure 4: Connecting the EK12 Wiegand Interface to the EK1000

Using Wiegand Device Readers

When using a Wiegand 26-bit device reader with the Easikey 1000, ID device administration is exactly the same as for Easikey key/card administration. For example, when this manual refers to presenting a key/card to the internal reader, simply use the external reader installed in place of using the internal reader.

Installing Readers and Connecting Lock Outputs

Readers

You may install the following types of readers with the EK1000. See the *Radionics Product Catalog(L100)* for a full list of compatible readers and their part number.

- You may install the following types of readers with the EK1000.
- Easikey proximity readers
- Readykey proximity readers
- Readykey PIN readers
- Wiegand 26-bit reader with an Easikey EK12 Wiegand Interface

Wiring Considerations for All Readers

The Easikey and Readykey readers are designed to withstand electrical interference, however, avoid routing cable close to heavy load switching cables and equipment.

Reader Connections

All Easikey and Readykey readers have four terminals. +V, VCA, SIG and -V. Connect each reader to the EK1000 at the Reader 1 or Reader 2 terminal block.



Figure 5: Connecting the readers to the EK1000

One door cable for each reader channel: You should not connect two Easikey/Readykey readers into a single reader channel input. However, it is possible through programming to use both reader channels to control one lock output.

Door Contact (DC) terminals operate with EK1000 Plus systems only: The

DC input is only functional for the EK1000 Plus version of door controller. The DC connection allows the EK1000 Plus door controller to monitor doors and provides a Tamper detection feature for the reader and cable. Do not use this terminal if you are installing a standard EK1000 Door Controller.

All versions of the EK1000 have one more connection, Request to Exit (RTE). Use this connection to enable the Request to Exit input feature.

Reader Marking	Description	Connects to the six-terminal block on the Controller
+V	Supply: 12-18 volts	V+
VCA	Access Authorized or Door Unlocked, illuminates the green LED at the reader.	VCA
	Request to Exit	RTE
	Door Contact Monitoring	DC (EK1000 Plus Only)
SIG	The signal from the reader to the controller.	SIG
-V	Supply: 0 volts.	GND

Table 2: Terminal connections for readers

Use unshielded cable: For Easikey/Readykey proximity readers, Radionics recommends that you use unshielded cable to connect the readers to the EK1000.

Consider voltage drop on wire run: It is essential that on long cable runs, at least the minimum voltage is maintained at the reader. You can route the wiring up to 300ft/100m with 22 gauge wire.

Wiegand Reader Wiring

Attach Wiegand devices to the Ek12 Wiegand Interface. The interface converts the Wiegand serial number output into a format that is compatible with the Easikey 1000 controller.

There are two jumper connections on the Wiegand Interface circuit board. Set the jumpers as follows:

- Jumper J1 Open
- Jumper J2 Closed

Use shielded cable: Unlike Easikey/Readykey proximity readers, Radionics recommends that you use shielded cable to connect the reader to the EK12 Wiegand Interface.

Consider voltage drop on wire run: It is essential that on long cable runs, at least the minimum voltage is maintained at the reader. You can run the six-wire cable up to 300ft/100m with 22 gauge wire.

Refer to the EK12 Wiegand Interface Data Sheet for full installation and wiring details.

Mounting the Reader

Consider the following rules when installing the door readers:

- Mount readers at a convenient height, usually at about the height of a door handle on the unhinged side of the door. ADA stipulations may apply, check with local authorities having jurisdiction for your local mounting requirements.
- Mount readers at least 3ft/1m apart to prevent any interaction between them.
- Consider future service requirements such as access to cables, etc.

Request to Exit

Protect the Request to Exit Wiring from Tampering. Shorting the RTE to ground (-V) causes the EK1000 to operate the locking device for the programmed lock release time. Make sure that the request to Exit wiring is not accessible from outside the secure area if someone removes the reader on the outside of the secured door.

The Request to Exit switch (RTE) allows persons within the secure area to leave by signaling to the EK1000 to operate the lock output without using a key/card. The switch is necessary when the EK1000 Plus uses door monitoring to distinguish between a forced door and a valid exit.

Connect the Request to Exit device 'normally open' so that when users activate it, that it momentarily closes (see Figure 5).

If you choose, you can locate the device away from the door, for example, at a reception desk or as part of a door entry system. If required, you can connect more than one device in parallel.

Do Not use a latching Request to Exit device

If someone activates the Request to Exit device causing it to keep a maintained closure, the EK1000 causes the door to lock after five cycles of the Lock Release Time. If you installed an optional printer, the system prints an RTE Button Held Down report. The lock output will not activate again, until either a valid key/card read or the Request to Exit device goes back to an open condition (normal) then closes again.

Alarm Event Monitoring (Easikey 1000 Plus Only)

If you are installing the Easikey 1000 Plus system, as an option, you can add these additional features:

- **Door Monitoring**
This allows you to monitor each door by using a door contact switch. The system can generate Unauthorized Access and Door Left Open alarm messages to increase the security of the system.
- **Reader Tamper Detection**
The Easikey 1000 Plus system can detect when someone disconnects a reader from the system. It can also monitor the cable between the EK1000 and the reader for tampering.
- **Alarm Relays**
The EK1000 includes an alarm relay for each door channel. Use the alarm relays to activate an audible alarm or trigger a dialer when the controller detects

Unauthorized Access or a Door Left Open event.

Door Contact Monitoring (Easikey 1000 Plus Only)

The Easikey 1000 Plus can monitor door contacts and can generate the following events:

- If someone forces a door open, the door controller can create an `Unauthorized Access` alarm.
- If someone leaves a door propped open, the door controller can generate a `Door Left Open` warning.

In addition, when you use door contacts with the system, you can cause the door controller to clear remaining Lock Release Time when the door closes after someone passes through.

Connecting the Door Contact

Connect the door contact so that it is normally closed. When the door is open, the switch should open. When the door is closed, the switch should close.

The normally closed door contact connects to the Easikey 1000 Plus door controller between the DC and V- connections. Refer to Figure 5 for the door contact connection.

To help prevent false alarms:

- Keep reed switches away from magnetic fields, like those caused by magnetic locks. This is a particular problem with metal door frames.
- Make sure that the contact does not operate if the door moves in its frame.
- Make sure the door closer causes the door to latch closed and lock after someone passes through.

Reader Tamper Detection (Easikey 1000 Plus Only)

The DC connection provides a Reader Tamper Detection function. Reader Tamper is detected when the SIG line breaks at the same time as DC connection is opened. This is achieved whether or not a door contact is installed. To provide full protection of the cable and reader, terminate the DC wire at the reader's -V terminal (see Figure 5).

Reader Tamper detection doesn't work while the door is unlocked:

Reader Tamper detection does not operate when the door is manually unlocked, automatically unlocked by a Time Profile, or while the door is unlocked with a key/card or RTE.

Lock Outputs

Install all locks according to the manufacturer's instructions.

The EK1000 provides a lock output for each reader channel. These outputs provide 12 VDC output at 1 Amp each.

A 1 Amp Fast-Blow fuse is located next to the door connector. The fuse protects each locked output from over draw or short circuit.

Figure 6: Connecting the Locking Devices

You can set each output independently for fail-safe (power to lock) or fail-secure (power to unlock), see *Programming the Door Data* for more information.

Calculate voltage drop on existing wire run: Use a large enough wire gauge for the cable between the EK1000 and the lock to provide at least the minimum voltage required to operate the lock. The resistance of the cable and the current drawn by the lock will determine the gauge of wire that you should use.

Fire Escape Safety

You must install an Emergency Override switch for any fire door or escape route to unlock the electric locking device during an emergency (see Figure 6).

Typically you would install fail-safe locks (power to lock) with a normally closed break-glass or touch bar switch in the lock's power cable. When someone operates the break-glass switch, the power to the lock is removed causing the door to unlock without intervention from the EK1000.

Alarm Output Relay (Easikey 1000 Plus Only)

The Easikey 1000 Plus provides a relay on each door channel with Common, Normally Open, and Normally Closed terminals. Alarm relays active when an Unauthorized Access alarm or a Reader Tamper alarm event occurs.

Alarm Relay

Alarm Relay 1 activates when alarms occur on Reader 1. Alarm Relay 2 activates when alarms occur on Reader 2. Each relay deactivates when the door closes, or when the system administrator acknowledges the alarm.

Figure 7: Connecting the Alarm Output Relays

The relay contacts are rated at 2 Amps at 24V AC or DC.

Door left Open warnings do not activate the alarm relays.

Channel Interlock assigns Relay 1 to both door channels: When you use Channel Interlock, alarms on both readers activate Alarm Relay 1. The EK1000 will not activate Alarm Relay 2.

Free Exit and Emergency Override Option

When using the Emergency Override feature, the RTE signal is used to monitor an Emergency Override device, such as a fire pull switch or an input from a fire control panel. When using the Emergency Override feature, the EK1000 will activate the lock output until the RTE input goes back to the normal (open) condition.

When this feature is used with an EK1000 Plus, a Free Exit report is generated when the DC connection is opened.

Emergency Override affects Alarm Monitoring for the EK1000 Plus: This feature disables reader tamper detection and door alarm monitoring for the door that you select for this feature. See *Door Options* on page 28 for further information about enabling this feature.

Easikey 1000 Plus
Controller

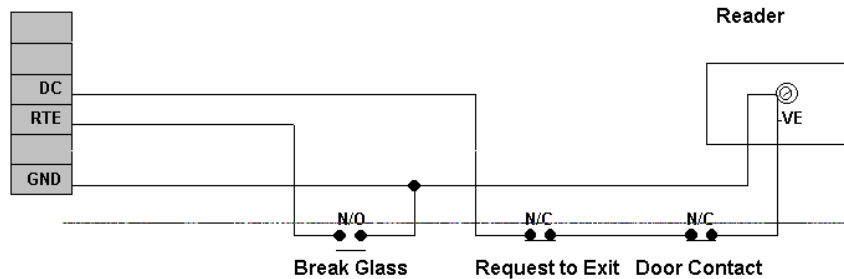

Special Case for Emergency Override and Free Exit

Figure 8: Connecting the Emergency Override Device

When connected as shown, operating the Emergency Override Device opens the door and causes the EK1000 to create an Emergency Override On report at the printer. When the device is restored, the EK1000 creates an Emergency Override Off report and locks the door.

Think "Fire Safety": You should **not** use Emergency Override as the sole means of escape. Even if this feature is being used it is still necessary to provide a manual means of exit.

Operating the System

Overview of System Administration

The System Administrator (Editor) is a person who supervises the Easikey 1000 system. Usually the administrator adds and removes authorized users from the system, directs what times and days users can pass through doors, and prints reports that log daily access activity throughout the system.

Editor Key/Cards are standard Easikey electronic key/cards that have been programmed into the system as a Sub Editor or Master Editor. This allows you to use normal key/cards that may grant access through the doors on the system for programming options.

The Easikey 1000 can have up to five System Administrators (Sub Editors) each administrator holding a special key/card that allows the administrator to perform special functions with the access system.

The Easikey 1000 also has a System Supervisor who is called a Master Editor Key/Card. The Master Editor is the only editor that can Add or Delete the five System Administrators (Sub Editors) along with the ability to perform all other programming options.

Using the Editor Key/Cards

Editor key/cards allow the System Administrator to control the Easikey 1000. With an editor key/card, the administrator can control doors, add and remove authorized users, print reports, and other special system functions.

There are two types of Editor key/cards. The difference between the two types is that only the Master Editor can add or remove Sub Editors, otherwise both types have exactly the same function.

Master Editor Key/Card

You can only program one Master Editor key/card into the system. This special key/card enables or disables the other Editor Key/Cards and adds and deletes users to the system. This key/card is typically stored in the Easikey 1000's enclosure, and used only to enable other Editor Key/Cards.

Your alarm company's installer created the Master Editor key/card when the system is first installed. You can change the Master Editor key/card at a later date if it is lost or stolen.

Sub Editor Key/Cards

The EK1000 requires you to present an Editor key/card to perform administration tasks with the system. This allows the administrator access to editing functions at the controller and also to accept alarms.

Editor Time-out

If after entering the Editor, no one presses any keys on the keypad or presents a key/card to the EK1000's internal reader for three minutes, the Editor will 'time-

out'. This means it will exit the Editor Mode and return to the normal display. To access the Editor mode again, you must present an Editor key/card to the internal reader again.

How to Use the EK1000 Keypad and Editor Mode

When you need to make changes to the system, present one of the five Editor key/cards to the built-in internal reader on the front of the door controller.

Use the External Reader to add alternate ID devices: If you are using an external reader for alternate styles of ID device, use the external reader in place of the system's internal reader. If the key/card is programmed as a valid Editor, the screen displays "SEL?".

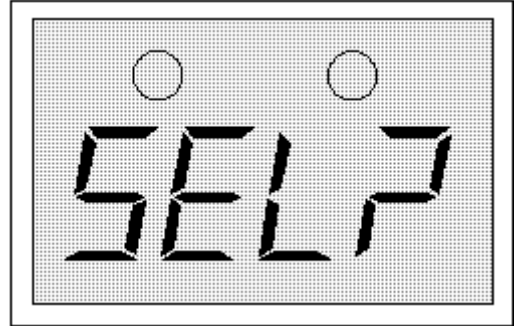

Figure 9: The EK1000 display

Using the Keypad

After accessing the Editor mode by presenting one of the Editor key/cards to the internal reader, the display will now show "SEL?". You may now press one of the following keys on the keypad:

PIN/1	Displays the user key/card's PIN number when you present the key/card
KEY/4	Allows you to add or edit system users
VOID/5	Allows you to remove users from the system
DOORS/6	Allows you to edit the door information and to control access doors
TIME/7	Allows you to create and edit Time Profiles and Time Periods for users and doors
PRINT/8	Allows you to print system reports
INST/9	Access to clock setting, add/delete Editor keys, set door channel interlock, set anti-pass back and upload/download
← → ↑ ↓	Arrow keys for moving around through records
SEL/SAVE	Used when entering data or to confirm operations
ESC	Leaves the editor

Entering Data

You will need to enter different types of information into the Editor. Here are some important points to remember.

- Whenever you add or change any data item you must press **SEL/SAVE** to confirm and accept the changes.
- You can press **ESC** to leave the data unaltered.

Different types of data entries use different methods:

Typing You must type numbers when entering a user number to the system or to enter time in a Time Profile. When you press each number, the cursor position (a flashing underline) flashes at the current character position. You can use the arrow keys ← → to move the cursor position.

Toggling Pressing certain keys changes the state of the data entries. For example, when changing days of the week in Time Profiles, pressing 1 for Monday, 2 for Tuesday, etc., can turn days of the week on or off. If the day is ON, pressing the key for that day will switch it OFF.

System Displays and Alarms

The EK1000 door controller will display various characters on its four-character display and produce a sound as a response to certain conditions. These are described below.

Also included in this section are example printouts produced when a printer is attached to an Easikey 1000 when the various condition described takes place.

Power Indicators

When the Editor is not being used (to add/delete users, etc.) the red and green LEDs are used as power indicators. While in the Editor the power indicators will be turned off. The power indicating LEDs operate normally as follows:

- The red LED is constantly illuminated indicating that AC power is supplied to the system.
- The green LED is constantly illuminated when the battery (if any) is low (less than 12 VDC).

Normal Displays

When nothing is happening and the system is idle the display is blank, and no sound are produced.

Whenever a door is opened normally or automatically, either with a key/card or by using a request-to-exit button, the display will look as shown here in Figure 10

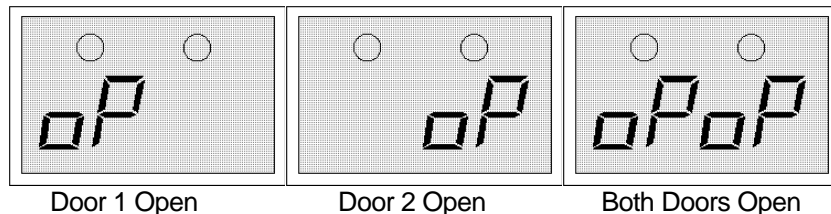

Figure 10: Normal displays

Printer example:

	Date	Time	Door	User	Transaction
[0123]	12/06/95	10:34	1	0092	Access Authorized
[0124]	12/06/95	10:35	2		Request to Exit
[0125]	12/06/95	10:50	2		Manual Unlock
[0126]	12/06/95	13:30	1		Automatic Unlock

Note: The remaining displays described in this section are only applicable to the Easikey 1000 Plus version of the door controller.

Door Left Open Warning (Easikey 1000 Plus Only)

The EK1000 Plus door controller only gives this warning if you are using door monitoring. If a door is left open longer than the time set then the **dt**, door open time described later in Door Programming, **OP** will start to flash on the display of the EK1000 for the particular door left open. The **OP** will continue to flash until the door is closed. There is no sound associated with this warning.

Printer example:

	Date	Time	Door	User	Transaction
[0233]	12/06/95	12:34	1		Door Left Open
[0234]	12/06/95	12:35	1		Door Closed

Unauthorized Access Alarm (Easikey 1000 Plus Only)

The door controller only gives this alarm if you are using door monitoring.

If someone opens a door without using a key/card, Time Profile being active, Manual Unlock used, or a Request to Exit button being pressed then the controller interprets this condition as Editor key/card, either the Master or a Sub Editor, to the EK1000's internal reader.

This alarm gives exactly the same displays and sounds as Cable or Reader Tamper (described next). However, the printed reports are different.

Display: **AL**, Flashing

Sound: Every two seconds

Cause: Unauthorized Access of Cable/Reader Tamper.

Silence: Present editor key/card to the EK100's internal reader to accept, and the alarm condition sound will stop.

Display: **AL**, Steady

Sound: Silent

Cause: Accepted Alarm or Cable/Reader Tamper.

The alarm condition still exists, either the door is still open or the cable/reader is still tampered.

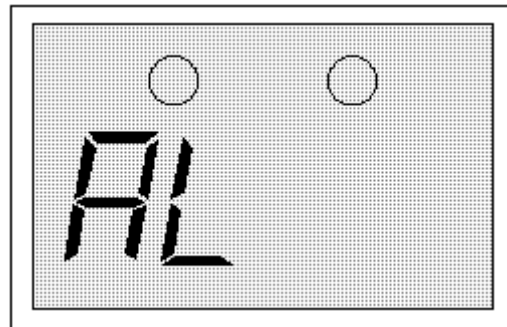

Printer example:

	Date	Time	Door	User	Transaction
[0278]	12/06/95	13:34	1		Unauthorized Access
[0282]	12/06/95	13:35	1	MASTER	Local Alarm Accepted
[0285]	12/06/95	13:37	1		Alarm Cleared

Cable or Reader Tamper Alarm (Easikey 1000 Plus Only)

The EK1000 Plus only gives this alarm if the reader has been wired to detect this condition.

This alarm gives exactly the same displays and sounds as an Unauthorized Access condition. However, the printed report is different.

Printer example:

	Date	Time	Door	User	Transaction
[0278]	12/06/95	13:34	1		Anti-tamper Alarm
[0282]	12/06/95	13:35	1	EDITOR - 1	Local Alarm Accepted
[0285]	12/06/95	13:37	1		Alarm Cleared

Alarm Relay Response (Easikey 1000 Plus Only)

This section describes response of the Alarm Relays when the system activates an alarm condition.

A relay output is provided on each door channel with a Common, Normally Open, and Normally Closed terminals. Both of these relays have the same function for the corresponding door channel.

The Alarm Relay activates when the corresponding door channel receives an Unauthorized Access or Cable/Reader Tamper alarm condition. The relay deactivates when the Alarm Condition clears or when an Editor accepts the alarm with the internal reader.

Example: Alarm Relay 1 activates for alarm conditions on reader/door channel 1 and Alarm Relay 2 activates for alarm conditions on reader/door channel 2. The relays deactivate when an Editor accepts the alarm with the internal reader or the door/cable tamper condition clears.

No relay response for Door Left Open: The relays do not respond to a Door Left Open condition.

Channel Interlock affects relays: When you use Channel Interlock, alarm conditions on both door channels activate Alarm Relay 1. The EK1000 does not use Alarm Relay 2.

Programming the System

This section fully describes the logical programming sequence used for system setup and use. This includes programming the Master and Sub Editors into the system along with full database programming used for the system.

Applying Power

Once you have installed the EK1000 door controller, readers and Request to Exit devices, and have connected the wiring to the electric locking devices, you are now ready to apply power to the EK1000. Follow this procedure for the initial start-up of the system.

1. Disconnect all reader, lock, and printer terminal blocks from the EK1000.
2. Connect the power supply to the corresponding terminals (AC or DC depending on the power supply you install) to the EK1000. The screen may briefly display 8888 and EK1000 will beep four times. The display will then clear and if you installed an AC power source, the Red power LED illuminates.
3. Connect the first reader.
4. If installed, operate the RTE for the first reader. If you did not install an RTE device, use a short piece of wire to short RTE to -V at the terminal block. The display should show *Op* and the green LED on the reader should illuminate.
5. Repeat for the second reader if used.
6. Now proceed to install the Master Editor Key/card.

Installing the Master Editor Key/Card

To install the Master Editor Key/Card:

1. Press and release the small Reset button, SW1, located at the top left-hand corner of the circuit board. The EK1000 will beep four times. While it is beeping, press and release the Reset button again. The display will flash horizontal bars.
2. Present a key/card to the EK1000's internal reader. This will become the Master Editor Key/Card.
3. The EK1000 will beep and the display alternates between *c1r* and *ALL?*. This means "Do you want to initialize and clear the whole database?" **If this is an existing installation, proceed to Item 4 now.**

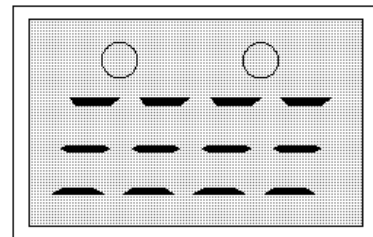

Figure 11: Horizontal Bars in the Display

4. If this is a new door controller that no one has programmed, then the answer should be "Yes". Press **VOID/5** followed by **SEL/SAVE** to initialize and clear the database. The display clears and the EK1000 installs the Master Editor Key/Card.
4. If this is an existing installation and you do not want to erase the database, then just press **ESC**. Use this step if you are just replacing the Master Editor Key/Card. The display clears and the EK1000 replaces the Master Editor Key/Card.

Testing the Master Editor Key/Card and System

Present the new Master Editor Key/Card. The display shows *SEL?* indicating that you are in the Editor mode and may select one of the functions .

When you install the Master Editor Key/Card after clearing the database, the EK1000 sets the following default parameters allowing you to immediately test the system:

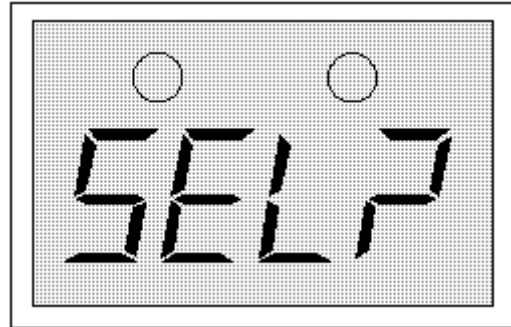

Figure 12: Entering the Editor

- The EK1000 also installs the Master Editor Key/Card as User key/card 0001 with access through both doors and with no Time Profiles set (all times and days).
- Each door is given a Lock Release Time of five seconds.
- Each lock is set to fail-secure (power to unlock).

If this is a new installation, Radionics recommends that the readers and locks should be tested now.

If you were replacing the Maser Editor Key/Card and have preserved the existing database, the new Master Editor Key/Card is the only change. The EK1000 still gives complete access to the Master Editor Key/Card. The Master Editor Key/Card normally loads into position 0001 replacing the old Master Editor ID unless someone has loaded another key/card into position 0001. If so, the EK1000 loads the Master Editor Key/Card into the next available position.

Installing and Voiding Additional Sub Editor Key/Cards

This feature allows you to add or delete up to five additional Sub Editor Key/Cards (Administrators) in the system. System Administrators use Sub Editor Key/Cards to add and delete users from the system, and to assign users to Time Profiles, etc. Only the Master Editor Key/Card can add or delete a Sub Editor Key/Card.

Adding a Sub Editor Key/Card

Step	Example Display	Action
1		Present the Master Editor Key/Card to the EK1000's internal reader.
2	<i>SEL?</i>	Press the INST/9 key.
3	<i>SetC</i>	Press ↓ 3 times until "Edit" is displayed.
4	<i>Edit</i>	Press SEL/SAVE .
5	<i>E000</i>	Present the new Sub Editor Key/Card to the EK1000's internal reader.
6	<i>E002</i>	At this time, if the red LED comes on and the number flashes then the Sub Editor Key/Card already exists in the database as an editor. If this is a new Sub Editor Key/Card then the green LED only will flash and the display will flash the Sub Editor number. The example shows Sub Editor Key/Card 2 as the next available number.
7	<i>E003</i>	Present the Master Editor Key/Card to the EK1000's internal reader. The green LED will now go steady and the next available Sub Editor number will flash. You may add more Sub Editors now if you wish by repeating Steps 5-7. Press ESC if you are finished programming Sub Editors.
8	<i>SEL?</i>	Press ESC to leave Editor.

Voiding an Sub Editor Key/Card

You cannot void the Master Editor Key/Card see *Installing the Master Editor Key/Card* on page 18 for instructions how to replace the Master Editor Key/Card.

Step	Example Display	Action
1		Present the Master Editor Key/Card to the EK1000's internal reader.
2	<i>SEL?</i>	Press the INST/9 key.
3	<i>SetC</i>	Press ↓ 3 times until "Edit" is displayed.
4	<i>Edit</i>	Press SEL/SAVE .
5	<i>E000</i>	<p>Either present the Sub Editor Key/Card that is to be voided to the EK1000's internal reader</p> <p>or: type the Sub Editor ID number and press SEL/SAVE</p> <p>or: use ↓↑ to select the Sub Editor ID number and press SEL/SAVE.</p> <p>Existing Sub Editor ID's or Key/Cards will flash along with the red LED, key/cards that are not in the Sub Editor database will flash with the green LED.</p>
6	<i>E003</i>	Present the Master Editor Key/Card to delete the Sub Editor Key/Card. There will be a short beep and the display will return to " <i>SEL?</i> ".
7	<i>SEL?</i>	Return to Step 2 above to delete more Sub Editor Key/Cards or press ESC to leave the Editor.

Setting the Clock

This item sets the clock that the EK1000 uses for Time Profiles and the time stamp for printed reports.

Checking the clock and calendar regularly is important when using Time Profiles, or if you are using the printer to log events. Use the following procedure for setting the clock:

- If at any point you enter an invalid value, like 15 for the month, you will get a long beep and the original value re-displayed.
- If the date is invalid, for example 02/31/95, then you will be returned to the year value in Step 4 in the procedure below. Re-enter the correct month and date.

Step	Example Display	Action
1		Present an Editor Key/Card to the EK100's internal reader.
2	<i>SEL?</i>	Press INST/9
3	<i>SetC</i>	Press SEL/SAVE
4	<i>Yr95</i>	Type the new year value (e.g. 95) and press SEL/SAVE . Press ↓ to move to the next item.
5	<i>Mt05</i>	Type the new month value (e.g. 05) and press SEL/SAVE . Press ↓ to move to the next item.
6	<i>Dt06</i>	Type the new date value (e.g. 06) and press SEL/SAVE .
7	<i>Dy2</i>	Type the day of the week, Mon=1, Tue=2, Wed=3, Thu=4, Fri=5, Sat=6, Sun=7, (e.g. 2=Tuesday) and press SEL/SAVE . Press ↓ to move to the next item.
8	<i>Hr11</i>	Type the hour and press SEL/SAVE . Press ↓ to move to the next item. Note: Use military time entries (e.g. 6:00 p.m. = 18:00 Hours).
9	<i>Mn08</i>	Type the minute (e.g. 08) and press SEL/SAVE . The clock is now set. Press ESC .
10	<i>SEL?</i>	Press ESC to leave the Editor.

Change the time for Daylight Savings Time: The EK1000 follows a true calendar year and recognizes leap year, but does not observe Daylight Savings Time so you may need to make local time adjustments for Daylight Savings Time.

Time Profiles and Time Periods

Overview of Time Profiles

You can restrict the use of a key/card to certain days and times. You can assign one of eight different Time Profiles to the key/card. If you assign a key/card a Time Profile of 0, the key/card has no time restrictions and its user can gain access through the system's doors 24 hours a day, 7 days a week.

Each Time Profile consists of up to three Time Periods, which contain the start and stop times along with the active days of the week.

Separate Doors and Users: Radionics recommends that you use different Time Profiles for doors and users even if they are identical. This means that if you require a change to the automatic door opening times at a later date, then these can be achieved without affecting the users programmed into the system key/card access times.

When using Time Profiles it is important to check the time and date at regular intervals, say once a month, to ensure that the system operates accurately.

In addition to the three Time Periods, each Time Profile has a status setting, either ON or OFF. When a Time Profile is in use its Status will be ON, when it is OFF the effect depends on the application.

- When applied to personnel, a Time Profile that is switched OFF will lock out all personnel with that profile until the Time Profile status is switched back ON.
- When applied to a door, a Time Profile that is switched OFF will stop the door automatically opening, it will also lock a door that is currently open according to that Time Profile.

Time Profiles for Doors

When you assign Time Profiles to doors, they automatically open the door at the begin time of each Time period and automatically close the door at the end time of each Time Period contained within the Time Profile.

Time Profiles for User Keys

Time profiles attached to a key/card allow access only when the time at which the key/card is presented falls within the Time Profile.

When Time Profiles Actually Begin and End

A Time Profile always starts at the **beginning** of the first minute of the time period, for example, when the time changes from 8:59 a.m. to 9:00 a.m. A Time Profile always finishes at the **end** of the final minute of the time period, for example, if a time period is meant to expire exactly at 5:00 p.m. (17:00), the correct entry for the end time would be 4:59 p.m. (16:59).

Time periods Do Not Cross Midnight

A time period cannot cross midnight. When it is necessary to cover such a time then two Time Periods are required, one from the begin time up to midnight (use 23:59), with another time period from midnight (use 00:00) to the end time.

24-Hour Operation

If you give a **door** a Time Profile of zero it will require a key/card 24 hours a day, 7 days a week. If you give a **user's key/card** a Time Profile of zero it will have access 24 hours a day, 7 days a week. If you are never going to use time controls of any type then there is no need to set up any Time Profiles at all, just use a Time Profile of zero for both doors and user key/cards.

Typical examples of Time Profiles are:

1. A public access door through which anyone can pass between 9:00 a.m. and 5:00 p.m. (17:00), Monday to Friday, but outside these hours a key/card is required.
2. Selected staff members are only allowed access between 8:30 a.m. and 5:30 p.m. (17:30), Monday to Friday; 8:30 a.m. to 12:00 p.m. Saturday.
3. Custodians are allowed access only between 7:00 a.m. and 9:00 a.m. Monday through Saturday.
4. Night shift workers can gain access between 8:00 p.m. (20:00) and 6:00 a.m. Monday to Friday. Proper use would be two Time Periods the first being 20:00-23:59, and the second being 00:00-06:00 along with the corresponding days of the week.

Programming and Editing Time Profiles

Setting up a Time Profile is achieved by presenting an Editor Key/Card and pressing the **TIME/7** key/card. The first display you will see is the status of Time Profile 1 shown as **t1St** alternating with ON or OFF.

It is best to think of the Time Profile database as a grid, eight rows representing Time Profiles, ten columns being one for the Status and three for each Time Period. Use the ← → ↑ ↓ keys to move a 'window' around the grid. If you attempt to move outside the window the EK1000 beeps.

	<i>n</i>	Stat. <i>tnSt</i>	begin <i>tnAb</i>	End <i>tnAE</i>	days <i>tnAd</i>	begin <i>tnbb</i>	End <i>tnbE</i>	days <i>tnbd</i>	begin <i>tnCb</i>	End <i>tnCe</i>	days <i>tnCd</i>
↑	1	on	0900	1700		0000	0000		0000	0000	
	2	on	0830	1730		0830	1200		0000	0000	
	3	on	0700	0900		0000	0000		0000	0000	
	4	on	2000	2359		0000	0800		0000	0000	
↓	5	oFF	0000	0000		0000	0000		0000	0000	
	6	oFF	0000	0000		0000	0000		0000	0000	
	7	oFF	0000	0000		0000	0000		0000	0000	
	8	oFF	0000	0000		0000	0000		0000	0000	

Wherever you are in the grid you will see the item name alternating with the item value. When you press a number keyed to make a change, the display will go steady. Changes are made as follows:

- Change the status by pressing the **1** key, for example, pressing 1 reverses the current display. Press **SEL/SAVE** when the EK1000 displays the correct status.

- Change times by typing the four digits in 24-hour format, for example, for 1:00 p.m. you would press **1,3,0,** and **0** for a value of 13:00 followed by **SEL/SAVE** to confirm your entry.
- The day periods are set by switching on or off seven vertical bars in the display. For instance, Monday to Friday is represented as seven vertical positioned across the display, while Saturday only would be represented as a vertical bar in the sixth position going from left to right. Changed each bar by pressing 1-7, where 1 represents Monday, 2 Tuesday, through 7 for Sunday.

To program Time Profile follow these steps:

Step	Example Display	Action
1		Present an Editor key/card to the EK1000's internal reader.
2	<i>SEL?</i>	Press TIME/7
3	<i>t1St / on</i>	The status of Time Profile 1 (may be either <i>on</i> or <i>OFF</i>). To move to another Time Profile use the ↑↓ keys to scroll through all eight Time Profiles.
4	<i>t1St / OFF</i>	Press 1 , the display will go to a steady and show <i>on</i> . Notice if you press 1 again the display will change back to <i>OFF</i> . Make sure <i>on</i> is displayed and press SEL/SAVE to confirm the change.
5	<i>t1St / on</i>	Press →.
6	<i>t1Ab / 0800</i>	The display now shows the begin time of period A. As an example type 0800 for 8 a.m. followed by SEL/SAVE to confirm the change. Notice how the display goes steady as soon as you press a key.
7	<i>t1Ab / 0800</i>	Press →.
8	<i>t1AE / 1700</i>	The display now shows the end time of period A. As an example type 1700 (for 5:00 p.m.) followed by SEL/SAVE to confirm the change.
9	<i>t1AE / 1700</i>	Press →.
10	<i>t1Ad / </i>	The days of the week for this Time Period will be active for period A. Type 1 for Monday, 2 for Tuesday, through 7 for Sunday, for the displayed days of the week that this Time Period is to be active. Press SEL/SAVE to confirm the changes. You will notice that as you press each number, the corresponding bar doubles in size. Press the same number again and it goes back to half size.
11	<i>t1Ad / </i>	Press →.
12	<i>t1bb / 0800</i>	The display now shows the begin time of period B. As an example type 0800 for 8am followed by SEL/SAVE to confirm the change.

Step	Example Display	Action
13	<i>t1bb / 0800</i>	Press → .
14	<i>t1bE / 1200</i>	Type the end time period B. As an example type 1200 for 12pm., followed by SEL/SAVE to confirm the change.
15	<i>t1bd / 10000</i>	Enter the days for period B. As an example type 6 for Saturday followed by SEL/SAVE to confirm the change.
16	<i>t1dd / 10000</i>	You have completed both Time Periods A and B for Time Profile 1. If you would like to program a third Time Period for Time Profile 1, Press → for Time Period C.
17	<i>t1Cb / 0000</i>	The default time should show 0000, if you would like to program a third start time enter it in now followed by SEL/SAVE to confirm the change. Press → to move to the end time for Time Period C.
18	<i>t1CE / 0000</i>	The default end time should show 0000, if you are using Time Period C type in the end time followed by SEL/SAVE to confirm the Change. Press → to move to the days of the week for Time Period C.
19	<i>t1Cd / 10000</i>	The default days of the week should show 10000. Type in the days of the week that you want this third Time Period C active, followed by SEL/SAVE to confirm the change. You have now successfully programmed Time Profile 1. Press ESC twice to leave Editor or repeat the step 3-19 for the other Time Profiles that you are using.

This completes the setting up of a complete Time Profile.

Programming the Door Data

When editing Door Data program entries, you will edit items for Lock Release Time, Door Open Time, Door Time Profile, Door Options, Lock Mode, Free Exit, RTE Report, and the Set/Reset features. These program items are described here in detail.

Lock Release Time

This is the amount of time that the EK1000 operates the lock output. Usually you will want to enable the lock output a sufficient amount of time to allow people to open the door. You may need to set a longer time for older or disabled people. When you using a EK1000 Plus with door monitoring, the EK1000 Plus door controller clears any remaining lock release time as soon as the door contact closes.

Door Open Time (Easikey 1000 Plus Systems Only)

This is the amount of time that the EK1000 Plus allows at the end of the Lock Release Time before the controller activates a Door Left Open warning. Installation of a door contact is required.

You must enter a value here if you are using door monitoring and/or reader tamper detection. A value of 0 disables door and reader tamper monitoring.

Door Time Profile

Enter in a Time Profile, 1-8 if the door requires automatic unlocking and locking of secured doors. Enter in a 0 if the door is to remain secured at all times, requiring a valid key/card or request to exit to pass through the door.

Door Options

Three are four options that you can program. The controller's display shows each as a vertical bar, full height when set, half height when not set. Door Option program items are listed here:

1 Lock Mode

UNSET	Lock operates as fail-secure, power applied to unlock door.
SET	Lock operates as fail-safe, continuous power to keep door secure, removed power to unlock.

2 Free Exit/Emergency Override

This option modifies the way that the DC (door contact) and RTE (request to exit) are monitored.

- UNSET The EK1000 Plus monitors door contact and reader/cable tamper. (RTE Programmed for Request to Exit)
- SET The EK1000 Plus will give Free Exit report without an alarm when the door is opened without a valid key/card or request to exit. On all versions of the EK1000 the RTE gives Emergency Override On report and unlocks the door when triggered (closed), Emergency Override Off report and locks the door when the RTE goes back to the normal condition (opened).

3 RTE Report

This option controls the type of report that the controller prints when RTE is operated.

- UNSET Request to Exit
- SET Request for Entry

4 Not Used - Leave UNSET

This option will be reserved for future use, and must remain unset for proper operation.

- UNSET Normal default setting.
- SET Reserved for future use.

5 Set/Reset

This option programs the door to open normally, following the programmed Lock Release Time, or to operate as a Set/Reset (toggle the output state) engaging the lock output and remaining engaged until a user presents a valid key/card again.

- UNSET Presenting a key/card to the reader releases the lock for the time specified by the Lock Release Time.
- SET Presenting a key/card to the reader releases (engages) the lock output. It stays in this state until a user presents a key/card again to the reader, then the lock output will disengages.

Using the Doors Function

Press ↑ ↓ at any time to move between Door 1 and Door 2.

Press ← → at any time to move between parameters. The parameters are presented in the order described earlier in Door Options.

Press **ESC** at any time to return to *SEL?*

Step	Example Display	Action
1		Present an Editor key/card to the EK1000's internal reader.
2	<i>SEL?</i>	Press DOORS/6 .
3	<i>d1Lt / 005</i>	Lock Release Time for door 1. Either: Type a new time, 0-255 , followed by SEL/SAVE to confirm the change, then press ↓ to go to door 2, or Press → to go to next parameter.
4	<i>d1dt / 000</i>	Door Open Time for door 1 used for the EK1000 Plus only. Either: Type a new time, 0-255 , followed by SEL/SAVE to confirm the change, then Press ↓ to go to door 2 or Press → to go to next parameter.
5	<i>d1tP / 0</i>	Time Profile for door 1. Enter in the Time Profile number 1-8 , if used, for automatically unlock and locking the door. Set as 0 , for no auto unlock/lock feature. Either: Type a new Time Profile 0-8 followed by SEL/SAVE to confirm the change, then Press ↓ to go to door 2, or Press → to go to next parameter.
6	<i>d1oP /IIII</i>	Door Options for door 1. See <i>Door Options</i> on page 28 for full descriptions of each option. Either: Press 1,2,3, or 5 to set or unset followed by SEL/SAVE to confirm the change, then Press ↓ to go to door 2, or Press → to go to next parameter.
7	<i>d1UL / LoC</i>	Manual Lock/Unlock for door 1. Used for manually Locking and Unlocking doors 1 or 2. <i>See Manual Lock/Unlock for Controlling the Doors on page 32 section for full details of use.</i> Press ESC twice to leave Editor or repeat the step 3-7 for entering the door parameters for door 2.

Channel Interlock

This feature allows the use of both door 1 and 2 readers as an entry and exit, interlocking the lock output to a single output for both readers.

When you use a reader on both sides of a door to monitor both entry and exit then it is only necessary to interlock to one lock output. The EK1000 operates the same lock output, Lock 1 for Reader 1 and Reader 2. The EK1000 does not use Lock 2. If you use Door Monitoring and RTE, the EK1000 assigns them to channel 1 also.

Programming Channel Interlock

Step	Example Display	Action
1		Present an Editor key/card to the EK1000's internal reader.
2	<i>SEL?</i>	Press INST/9
3	<i>SetC</i>	Press ↓ 4 times until the display shows <i>P00</i> .
4	<i>P00</i> or <i>P00</i> . If channel interlock is set.	Press → to toggle Channel Interlock ON/OFF, followed by SEL/SAVE to confirm the change.
5	<i>SEL?</i>	Press ESC to leave Editor.

Anti-Passback

If Channel Interlock has been used, this additional feature causes the EK1000 to monitor both the entry and exit through the secured area. When you enable Anti-Passback, the user may enter and exit only by using their key/card each way. If the EK1000 logs two entries attempts through a door by the same key/card without an exit between, it will not allow access to be granted for the second presentation of the key/card.

When you use two readers to control both entry into an area and exit out of the area then you may set anti-passback. If a user attempts to use the key/card to enter the area again, the EK1000 causes a *No Access; Pass Back* report on the printer. As with Channel Interlock, Channel 1 is considered the entry reader and Channel 2 the exit reader.

You can cause Passback to be active until the user presents a key/card to leave the area, or you can assign a time limit, after which the user can present the key/card to enter the area again. The time limit is useful if people are likely to leave the area without using their keys or cards, without the time limit they would be unable to get back in the area. This feature is often referred to a "Forgiveness Time."

Programming Anit-Passback

Step	Example Display	Action
1		Present an Editor key/card to the EK1000's internal reader.
2	<i>SEL?</i>	Press INST/9
3	<i>SetC</i>	Press ↓ 4 times until P00 is displayed.
4	<i>P00</i> or <i>P00.</i> if Channel Interlock is set.	Type a value, 0-60 (0 to unset), followed by SEL/SAVE to confirm the change. 0 No pass back 1 Pass back with no forgiveness time limit. 2-60 Number of minutes after which a key/card will work again if it is not used to leave the area.
5	<i>P15</i> (with an anti-passback time set to 15 mins)	As an example, a value of 15 sets Anti-Passback with a forgiveness time of 15 minutes.
6	<i>SEL?</i>	Press ESC to leave Editor.

Manual Lock/Unlock for Controlling the Doors

It is possible to manually lock and unlock a door from the EK1000. It may be necessary to do this, for instance, when a door needs to be kept unlocked while contractors are working in an area, or equipment is being moved around. Also a door that is normally open or a Time Profile may need to be locked while a receptionist or guard is not available.

Doors controlled by a Time Profile

Manual lock will lock the door. The EK1000 requires users to present their keys/cards to gain access when doors are locked. If you do not manually unlock the door, the door will unlock again at its next automatic opening time according to the Time Profile assigned.

If you manually unlock a door, and then do not manually lock the door, the door will lock again at its next automatic closing time according to the Time Profile assigned.

Doors not controlled by a Time Profile

Manual unlock will unlock the door and it will stay unlocked until manually locked again.

To Lock/Unlock a Door

Use the following procedure to lock/unlock a door:

Step	Example Display	Action
1		Present an Editor keycard to the EK1000's internal reader.
2	<i>SEL?</i>	Press DOORS/6
3	<i>d1Lt / 0005</i>	Press → 4 times until the display shows <i>d1UL / Loc</i>
4	<i>d1UL / Loc</i>	The display now shows the current state of door 1 (<i>Loc</i> =locked, <i>ULoc</i> =unlocked).
5	<i>d1UL / Loc</i> or <i>d2UL / Loc</i>	To unlock a door press 1 followed by SEL/SAVE to confirm the change, the display will change to <i>ULoc</i> and the door will unlock. To lock a door press 0 followed by SEL/SAVE to confirm the change, the display will change to <i>Loc</i> and the door will lock.
6	<i>SEL?</i>	Press ESC to leave the Editor or Press the ↓ to manually control door 2.

Access Levels & Time Profiles

You can assign each key/card an Access Level and a Time Profile. This defines which doors the EK1000 will allow the key/card through, and at what times and days the user can present the key/card for access through the door.

If you decide to use access levels and/or Time Profiles then it is a good idea to group all users with the same access requirements together. This makes adding blocks of keys and cards much easier.

Access Levels

You can allow a key/card access to door 1 only, door 2 only, both doors, or neither door. Allowing a key/card access to neither door can be useful when a key/card

is lost or stolen. Rather than using VOID it may be better to lock the key/card out, then if the EK1000 is connected to a printer there will be a record if someone makes an attempt to use the key/card that was missing.

When adding or editing a key/card the EK1000 displays the access level as two dots on the right of the display, the left half of the display indicates the key/card's Time Profile. If the first dot is illuminated (left), that key/card will have access to door 1, the second dot (right) indicates access to door 2. If neither dot is illuminated, the key/card is locked out and will not be allowed access through either door.

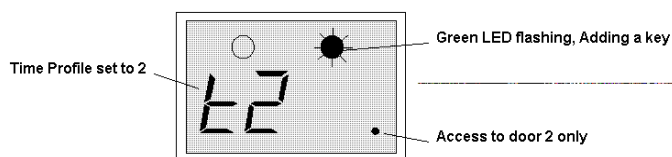

Figure 13: Indicators of Access Levels and Time Profiles for Users

User (Key/Card) Numbers

When you add a new key/card to the EK1000, the EK1000 door controller assigns the key/card a number between 0001 and 1000. Normally when you add a key/card the controller assigns it the first available number in the list. For example if a system contained keys 0001, 0002, 0003, 0004 and 0006, the EK1000 would assign the next key/card added to number 0005. The EK1000 would assign next following key/cards to numbers 0007, 0008 and so on. It is possible to override the automatic numbering and give a key/card a specific number, provided the number is not currently being used by another key/card.

It is important to keep a record of key/card numbers you issue and who they belong to on the *Easikey 1000/1000 Plus Programming Record Sheet* (74-07580-000). It may be necessary to void a lost key/card at a later date, in which case, you must know the number given to the lost key/card if you do not have it in your possession.

Adding or Editing Users

Follow this procedure for adding a new key/card to the EK1000. If you are adding more than one new key/card, see *Adding Several Keys* on page 36.

Step	Example Display	Action
1		Present an Editor key/card to the EK1000's internal reader.
2	<i>SEL?</i>	Press the KEY/4 key.
3	<i>0000</i>	Present a new key/card to the EK1000's internal reader.
4	<i>0019 / t0.</i>	At this point if both the green and red LEDs come on then the key already exists in the database and may be edited (see <i>Editing a Key</i>). If this is a new key/card then the green LED only will flash and the display will alternate between the next available key/card number and the Time Profile and Access Level. This example shows key/card 0019 as the next available number. At this point you may wish to select your own number rather than the number given by the EK1000. If not then go to step 6 below. To select an alternative number press SEL/SAVE , the display will change to 0000.
5	<i>0000</i>	Now either type in the number you require and press SEL/SAVE to confirm the change, or use the ↑ and ↓ keys to go up and down the list of numbers. Numbers already assigned will flash with the red and green LEDs steady, free numbers will alternate with their Time Profile and Access Level and the green LED flashing. Press SEL/SAVE to confirm the number that has been chosen.

Step	Example Display	Action
6	0019 / t0 .	Now changes can be made to the Access Level and Time Profile. If no changes are to be made go to step 8.
7	0019 / t1 .	<p>To change the Time Profile press 0-8 for the Time Profile you wish to apply. (As soon as you press a key the display will stop alternating). A Time Profile of 0, allows for 24 hour access, 7 days a week. Press SEL/SAVE to confirm the change. The display will start flashing again.</p> <p>To change Access Levels press ← to toggle on/off the dot for door 1, and → to toggle on/off the dot for door 2. Press SEL/SAVE to confirm the change.</p> <p>The example shows key 0019 with Time Profile 1 and access through door 2 only.</p>
8	0020 / t1 .	Present the Editor key/card (it must be the same one as used in step 1 above) to the EK1000's internal reader. The green LED will now go steady and the next available number will flash. If you wish to add more keys see <i>Adding Several Key/Cards</i> next otherwise press ESC .
9	SEL?	Press ESC to leave Editor.

Adding Several Keys

When you want to add several keys or cards at one time, follow the previous steps used in *Adding or Editing Users* on page 34.

When step 8 is complete, instead of pressing **ESC**, continue to follow the steps described here. This feature is also sometimes referred to as Block Adding

Step	Example Display	Action
9	0020 / t1 .	The green LED will be steady and the next available key/card number will be alternating with the same Access Level and Time Profile that was previously used for the key/card that was just programmed into the EK1000. Make any necessary changes to the Access Level and Time Profile following the steps mentioned earlier in <i>Adding or Editing Users</i> . You will notice that any changes are carried over to the next key/card making it very convenient for bulk adding of key/cards with the same access requirements. Present the new key/card to the EK1000's internal reader - there is no need to present an Editor key/card until all the desired key/cards have been added.
10	0021 / t1 . 0022 / t1 . 0023 / t1 .	Continue presenting new keys and cards, one after the other, until all key/cards are recorded. If a key/card is presented that is already in the database then its number will briefly be displayed before the display returns to the next available number. If you fill the database with 1000 key/cards then the display will show FULL .
11	0024 / t1 .	When finished either press ESC or present the Editor key/card.
12	SEL?	Press ESC to leave Editor.

Editing a Key/Card

To change the Access Level or Time Profile assigned to a key/card the EK1000 requires either the key/card itself or the number assigned to the key/card to be in the Editor's possession. Edit the key/card using the following procedure.

Step	Example Display	Action
1		Present an Editor key/card to the EK1000's internal reader.
2	SEL?	Press the KEY/4 key.

Step	Example Display	Action
3	0000	Either: present the key/card that you wish to edit to the EK1000's internal reader, or: type the key/card number and press SEL/SAVE to confirm the number entered, or: use ↑↓ to select the key/card number and press SEL/SAVE to confirm the number. If the green LED is flashing then the key/card presented is not in the system or the number selected is unused.
4	0019 / t1 .	If the key/card presented or the number selected is in the database then both red and green LEDs will be on, and the display will be alternating between the key/card number and the Access Level and Time Profile assignment. In the example key/card 0019 has been selected, and has Time Profile 1 assigned and is allowed through both doors. Make any changes as described in Step 7 of <i>Adding or Editing Users</i> on page 34.
5	t2 .	The display will go steady, press SEL/SAVE to confirm the change.
6	0019 / t2 .	You will be returned to the alternating display. Return to step 3 if you want to change other key/cards or Press SEL/SAVE if you want to type another number. Otherwise press ESC .
7	SEL?	Press ESC to leave the Editor.

Displaying a Key/Card PIN Number

If you are using Readykey PIN readers with the system, it is necessary to know the PIN Number before you issue the key/card to the user. The user must present the key/card to the reader, then the user must enter the PIN Number to open the door. To find the PIN associated with a key/card follow these steps described here.

Step	Example Display	Action
1		Present an Editor key/card to the EK1000's internal reader.
2	SEL?	Press PIN/1 key.
3	<i>Show/Id</i>	Present the key/card desired to the EK1000's internal reader to acquire the PIN Number.
4	1234	The PIN Number displayed.

The EK1000 does not assign the PIN Number: You cannot change the PIN. It is contained within the key/card and not programmable.

Identifying a Key/Card

If someone finds a key/card, you can identify the key/card by presenting it to the controller's reader and following these steps:

Step	Example Display	Action
1		Present an Editor key/card to the EK1000's internal reader.
2	<i>SEL?</i>	Press the KEY/4 key.
3	<i>0000</i>	Present the key/card to the EK1000's internal reader.
4	<i>0019 / t1 .</i>	<p>If the key/card exists in the database then the red and green LEDs will be steady and the key/card number, alternating with the Access Level and Time Profile assigned, will be displayed.</p> <p>Refer to the <i>EK1000/1000 Plus Program Record Sheet</i> (74-07580-000) for reference of which user the key/card has been assign to.</p> <p>Press ESC twice to leave the Editor or make any changes if necessary.</p>

Voiding Key/Cards (Users) from the EK1000

You can remove a key/card from the database provided you have the key/card or you know its number.

To Void a key/card use the following procedure:

Step	Example Display	Action
1		Present an Editor key/card to the EK1000's internal reader.
2	<i>SEL?</i>	Press the VOID/5 key.
3	<i>0000</i>	<p>The red LED will be lit.</p> <p>Either: present the key/card to be removed to the EK1000's internal reader. If you present a key/card that does not exist then there will be a long beep from the EK1000.</p> <p>or: type the key/card number and press SEL/SAVE to confirm,</p> <p>or: use ↑↓ to select the key/card number and press SEL/SAVE to confirm.</p> <p>Valid key/cards that are present in the database will flash along with the red LED, Invalid key/cards will flash with red and green LEDs steady.</p>

Step	Example Display	Action
4	0019	Present the Editor key/card to delete the key/card desired. There will be a confirming beep and the display will return to SEL?.
5	SEL?	Return to step 2 above to delete more key/cards from the database or press ESC to leave the Editor.

Voiding Editor keys: If you need to void and Editor key/card, see Installing and Voiding Additional Sub Editor Key/Cards for more information.

Additional System Options

Software Version Display

This feature allows for recording the EK1000's current software version. You may need this information for Technical Support personnel to explain what feature options are available for your current EK1000.

Step	Example Display	Action
1		Present an Editor key/card to the EK1000's internal reader.
2	SEL?	Press INST/9
3	SetC	Press ↓ 5 times until v???. The "???"s represent the version software number.
4	v100	In this case the display shows version 1.00,. This is the software revision for this EK1000. Press ESC .
5	SEL?	Press ESC to leave Editor.

Upload/Download Option

This feature enables communication between two EK1000s for a database transfer from one EK1000 to another.

It is possible to use the printer ports on two Easikey 1000 controllers to copy the database from one to the other. To do this a cable will need to be made up as follows:

Use 22 gauge, four-wire, unshielded cable, maximum length 30ft/15m.

Easikey 1000 Printer Port		Easikey 1000 Printer Port
GND (27)	-----	GND (27)
DTR (28)	-----	CTS (30)
RX (29)	-----	TX (31))
CTS (30)	-----	DTR (28)
TX (31)	-----	RX (29)

After you connect the two controllers, use the following procedure to transfer the database records between the two EK1000s:

Press ESC to cancel the transfer at any time.

Step	Sending Unit	Receiving Unit	Action
1			Present an Editor key/card to each EK1000's internal reader.
2	<i>SEL?</i>	<i>SEL?</i>	Press INST/9 at each controller.
3	<i>SetC</i>	<i>SetC</i>	Press ↓ at each EK1000.
4	<i>in</i>	<i>in</i>	Press ↓ again at sending EK1000 only.
5	<i>oUt</i>	<i>in</i>	To start the transfer: Press SEL/SAVE twice on the receiving EK1000 then: Press SEL/SAVE on the sending EK1000.
6	<i>oUt / nnn</i>	<i>in / in</i>	The sending controller will display <i>oUt</i> alternating with the percentage complete. The receiving controller will flash <i>in</i> . When complete, both displays will return to <i>SEL?</i>
7	<i>SEL?</i>	<i>SEL?</i>	Press ESC to leave Editor.

Display Last Five Keys or Cards Used

You do not need a special key: No Editor Key/card is required for this function.

You can cause the EK1000 to display the last five key/cards that users presented at the system's readers. Follow the steps below:

- Press the **KEY/4** key. This displays the last key/card to be used with the left (red) LED lit if access was through door 1. The right (green) LED is lit if access was through door 2.
- Press **KEY/4** key to display the next key/card used. Up to five keys can be displayed. On the sixth press the display goes blank.

Controller leaves this mode automatically: The display will blank after ten seconds if no key is pressed on the keypad.

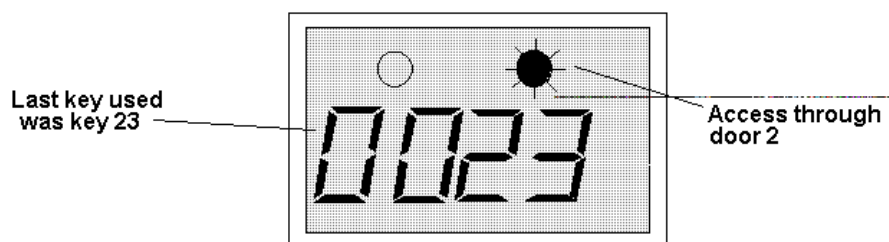

Figure 14: Displaying the last five key/cards used on the system

Transaction Logging

All Easikey 1000 door controllers keep a record of the most recent 1000 transactions that may occur such as Access Authorized, Manual Lock, Automatic Lock, Editor On, etc. See Transaction Event Definitions for full details on the meaning of each type of transaction.

When a printer is connected, the EK1000 will print these events as they happen. If the printer is switched off, or otherwise disconnected, then the events will be stored and printed from the point at which printing stopped when the printer is reconnected.

The only action the user need take is to ensure that the printer is kept supplied with paper and does not jam - make sure the paper flows freely through the printer.

Sample transaction printout

	DATE	TIME	DOOR	USER	TRANSACTION	01/06/95
[0054]	01/06/95	12:09	2		Door Left Open	
[0055]	01/06/95	12:10	2		Door Closed	
[0056]	01/06/95	12:14	1	0045	Access Authorized	
[0057]	01/06/95	12:14	2	0052	No Access: Level	
[0058]	01/06/95	12:15		EDITOR -1	Editor On	
[0059]	01/06/95	12:17		EDITOR -1	Editor Off	
[0060]	01/06/95	12:18	1		Request to Exit	
[0061]	01/06/95	12:19	1	0045	Access Authorized	
[0062]	01/06/95	12:23	1	0045	Access Authorized	
[0063]	01/06/95	12:30	1		Automatic Unlock	
[0064]	01/06/95	12:33	2	0120	No Access: Time	
[0064]	01/06/95	12:42	2		Unauthorized Access	

[0065]	01/06/95	12:43	2	MASTER	Local Alarm Accepted
[0066]	01/06/95	12:44	2		Alarm Cleared

Transaction Event Definitions

This reference section shows the meanings of events printed by the system.

Normal Entry and Exit

Access Authorized	Normal key/card authorization.
Entry Authorized	Only used when Anti-PassBack or Channel Interlock is set. Key/card has entered area.
Exit Authorized	Only used when Anti-PassBack or Channel Interlock is set. Key/card has left he area.
Request to Exit	Normal use of Request to Exit switch.
Request for Entry	Special use of Request to Exit switch. See Setting the Door Data.
Free Exit	Special use of Door Monitoring. See Setting the Door Data.

Alarms and Warnings

Unauthorized Access	A door contact has opened without a valid key/card being used or Request to Exit being pressed. EK1000 Plus Only
Anti-tamper Alarm	The cable has been cut or the reader removed or disconnected and broken the connection to the door contact also. EK1000 Plus Only
Local Alarm Accepted	An Editor key/card has accepted the alarm.
Alarm Cleared	The previous alarm condition has been cleared, i.e. the door has been secured or the Reader Tamper has been reconnected.
Door Left Open	The door has been left open longer than the pre-set time. EK1000 Plus Only
Door Closed	The door has closed again after being left open. EK1000 Plus Only
RTE Button Held Down	The RTE switch is being held down.
Repeated Token Use	The same key/card has been presented more than 5 times in succession the reader.

No Access

No Access: Unknown ID	A key/card has been presented that is not currently enrolled into the EK1000's database.
No Access: Locked Out	A key/card with no access allowed at either door has been presented.
No Access: Level	A key/card with no access allowed at the door has been presented. The key/card is allowed only through the other door.
No Access: Time	A key/card currently excluded from this door with a Time Profile.
No Access: Pass Back	A key/card has been excluded because it has attempted to be used twice on the same reader in succession.

Door Events

Automatic Lock	The door has locked automatically via a Time Profile.
Automatic Unlock	The door has unlocked automatically via a Time Profile.
Manual Lock	An Editor has Manually Locked the door.
Manual Unlock	An Editor has Manually Unlocked the door.

Other Events

Editor on	An Editor key/card has entered the Editor.
Editor Off	An Editor key/card has left the Editor or the Editor has timed-out.
Emergency Override On	Special use of Request to Exit. The switch is monitoring an emergency switch (e.g. a break glass).
Emergency Override Off	Special use of Request to Exit. The switch is monitoring an emergency switch (e.g. a break glass).
Unit Closed Down	Power removed from the EK1000.
Unit Started Up	The EK1000 has been switched on.

Printing Reports

User Selected Reports

There are three features accessible to the user from the PRINT/8 key.

- Printout of the database including Personnel, Time Profiles and Door Data.
- Printout of transactions applying to an individual key/card.
- Clearing all transactions in the controller.

To Print the Database

This function prints personnel, Time Profile, and Door Data. The printer will automatically go to the top of a new page, the display will show the progress of the report.

Press **ESC** to interrupt the printout at any time.

1		Present an Editor key/card to the EK1000's internal reader.
2	<i>SEL?</i>	Press the PRINT/8 key
3	<i>PrdA</i>	Press SEL/SAVE to start database printout.
4	<i>db / Prnt</i> <i>tP / Prnt</i> <i>dr / Prnt</i>	..printing personnel database ..printing Time Profiles ..printing door data
5	<i>SEL?</i>	Press ESC to leave Editor.

Sample database printout

Easikey 1000 SYSTEM PERSONNEL PRINTOUT 01/06/95 11:10 page 01

ID	DOORS	TIME 1	TIME 2	TIME 3
0001	Both			
0002	One	08:30 17:30	MIWTF-- 08:30 12:00	-----S- 00:00 00:00 -----
0003	Two	08:30 17:30	MIWTF-- 08:30 12:00	-----S- 00:00 00:00 -----
0045	Both			
0052	One			
0064	Both	20:00 23:59	MIWTF-- 00:00 08:00	-TWTFs- 00:00 00:00 -----

Easikey 1000 SYSTEM TIME PROFILE PRINTOUT

RECORD	STATUS	TIME 1	TIME 2	TIME 3
1	On	09:00 17:00	MIWTF-- 00:00 00:00	----- 00:00 00:00 -----
2	On	08:30 17:30	MIWTF-- 08:30 12:00	-----S- 00:00 00:00 -----
3	On	07:00 09:00	MIWTFs- 00:00 00:00	----- 00:00 00:00 -----
4	On	20:00 23:59	MIWTF-- 00:00 08:00	-TWTFs- 00:00 00:00 -----
5	Off	00:00 00:00	----- 00:00 00:00	----- 00:00 00:00 -----
6	Off	00:00 00:00	----- 00:00 00:00	----- 00:00 00:00 -----
7	Off	00:00 00:00	----- 00:00 00:00	----- 00:00 00:00 -----
8	Off	12:30 13:30	MIWTF-- 00:00 00:00	----- 00:00 00:00 -----

Easikey 1000 SYSTEM DOOR DATA PRINTOUT

Door 1 LOCK TIME = 005
DOOR TIME = 010
TIME PROFILE = 8
OPTIONS = Reverse Lock, Request to Exit
DOOR = Locked

Door 2 LOCK TIME = 005
DOOR TIME = 010
TIME PROFILE = 0
OPTIONS = Request to Exit
DOOR = Locked

Printing Selected Key/card Transactions

This will print all the transactions associated with a particular key/card number current in memory. The period of time this covers will depend on how long the system takes to generate 1000 transactions.

Press **ESC** to interrupt the printout at any time.

1		Present an Editor key/card to the EK1000's internal reader.
2	SEL?	Press the PRINT/8 key
3	PrdA	Press the ↓ .
4	Prtr	Press SEL/SAVE .
5	0000	Type the key/card number you require, press SEL/SAVE to start the printout. There may be a short pause while the controller searches through all the transactions.
6	tr /Prnt	..printing transactions
7	SEL?	Press ESC to leave the Editor.

Sample Transaction Printout for User 45

Easikey 1000 SYSTEM PERSONNEL PRINTOUT 01/06/95 11:10 Page 01					
	DATE	TIME	DOOR	USER	TRANSACTION
[0056]	01/06/95	12:14	1	0045	Access Authorized
[0061]	01/06/95	12:19	1	0045	Access Authorized
[0062]	01/06/95	12:23	1	0045	Access Authorized
[0092]	01/06/95	12:30	2	0045	No Access: Level

Clearing the Transaction Database

This is useful if no printer has been connected for some time and you do not want up to 1000 old transactions to be printed.

1		Present an Editor key/card to the EK1000's internal reader.
2	SEL?	Press the PRINT/8 key
3	PrdA	Press the ↓ .
4	Prtr	Press the ↓ .
5	CLrt	Press SEL/SAVE to confirm.
6	CLr /ALL?	Press VOID/5 followed by SEL/SAVE to erase all transactions from memory. There will be a short confirming beep.
7	SEL?	Press ESC to leave the Editor.

Glossary

Anti-Tamper	A means of detecting unauthorized disconnection of cables or removal of covers from security equipment.
Block Add	If a large number of keyholders are to be entered into the database, it may be more convenient to enter all the names, access groups, etc. first, then to assign the keys at a later date. The Personnel application includes a special 'Block Add' utility for this purpose.
Reader Channel	A term used to describe the connections on a door controller for a single door - i.e. reader, locks and request to exit and door contact inputs.
Door	Although this term is usually used to refer to a physical door at which a reader is installed, it is useful to remember that sometimes each physical door may have a reader installed on both sides - in this case it would be referred to as two 'doors' in the context of the system.
Door Contact	A device, usually a magnetic switch, which may be installed on a door to monitor whether the door is open or closed.
Door Controller	A microprocessor based unit from which up to two doors may be controlled. The door controller reports to and is administered by the PC(s). The door controller makes the decision as to whether access is to be allowed.
Door Open Time	If a door has a means of monitoring its state (closed or open) installed, then it is possible to configure the system to produce a transaction if the door is held open beyond a specified time.
Fail Safe / Fail Secure	<p>These terms are used to describe the two common types of locks available.</p> <p>Fail Safe locks (also sometimes called 'Power to Lock') require a permanent supply to keep the door locked. This type of lock would normally be used if safety was most important - i.e. in the event of equipment failure the door would become unlocked.</p> <p>Fail Secure locks (also called 'Power to Unlock') require power to unlock the door.</p>
Key/card	An electronic identification device containing a unique code. This device is held near to a Readykey reader to allow the code to be read, the door controller then decides whether to release the lock.

Lock Time	The time that a door will be unlocked following a valid key/card being presented at a reader or a request to exit button being pressed. Note: that this time may be shortened if a door contact is installed and the door opens and re-closes before the lock time expires.
PIN Reader / PIN Number	A K2001-P PIN reader is a special type of Readykey reader which is commonly used where an additional level of security is required. To gain access through a door, the keyholder must present their key, followed by typing their 4-digit number. The PIN number is derived from the key code and cannot be changed.
Reader	A device installed adjacent to a door, which reads the stored code when a key/card is held close to it by a keyholder, and transmits to the door controller. The reader also incorporates an 'Access Authorized' LED.
Report	A printed list of information about a part or all of the system.
Request To Exit	A N.O. switch, normally mounted on the secure side of the door allows exit from the area, without need for a key to be presented. Operation of this switch generates a 'Request to Exit' transaction.
Time Period	A means of defining a limited time during which access may be controlled. Consists of a start time, end time, and one or more days.
Time Profile	A group of up to three Time Periods, which may be assigned to an access group to restrict a keyholders access to within the defined time limits. May also be assigned to a door to unlock the door during the defined time.
Transaction	Any event that occurs on an Easikey system is called a transaction. All transactions which originate from a door controller are reported to the printer.
Unauthorized Access	A special kind of alarm transaction which occurs when a door is opened without a valid key being presented to the reader, or the request to exit switch being pressed.

Specifications

Power Input

AC Terminals 34 and 36

16.5 VAC or 24 VDC

Battery Terminals 32 and 33

One or two D126 12 VDC 7 Ah Batteries. If using two batteries, use D122 Dual Battery Harness

Power Output

Lock

12 VDC @ 1 Amp Continuous

Environmental

Temperature

32° - 122° F

Relative Humidity

85% Non-condensing

Doors

Connect up to two doors

Optional Anti passback

Optional Channel Interlock

Optional set / reset

Users

Assign up to 1000 key/cards to the system

Transaction Buffer

Up to 1000 events stored for printing

Printer Output

Five-wire Serial Communication

Time Profiles

Assign up to eight Time Profiles to users or doors

Enclosures

D7103

D8103 with a D7102 mounting skirt

EK1000 Plus

Optional Door Contact Monitoring

Optional Alarm Relay

Notes