

# Channel Plus®

PERFORMANCE MULTI-ROOM VIDEO

## Modulator Installation Manual

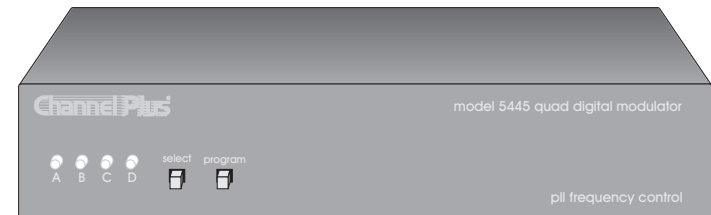

## Frequency-Agile Multi-channel Modulators

Models  
5425/5435/5445

 **multiplex®**  
technology, inc. 

3001 Enterprise Street, Brea, CA 92821-6213, U.S.A.  
714-996-4100 \* 800-999-5225 \* FAX 714-996-4900 \* [www.channelplus.com](http://www.channelplus.com)

# Controls and Connections

The ChannelPlus 5400 Series are digitally-tuned video modulators that convert any baseband video and audio signal to a user-selected UHF, or Ultraband CATV. An internal quartz crystal reference oscillator and PLL circuitry ensure drift-free performance. The user selects the output frequency (channel) using the "select" button to choose which modulator and the "program" button to enter the number of the desired channel. Any TV connected to the output via coax can receive the signals, when the TV is tuned to the proper channel.

## Model 5445 - four agile modulators

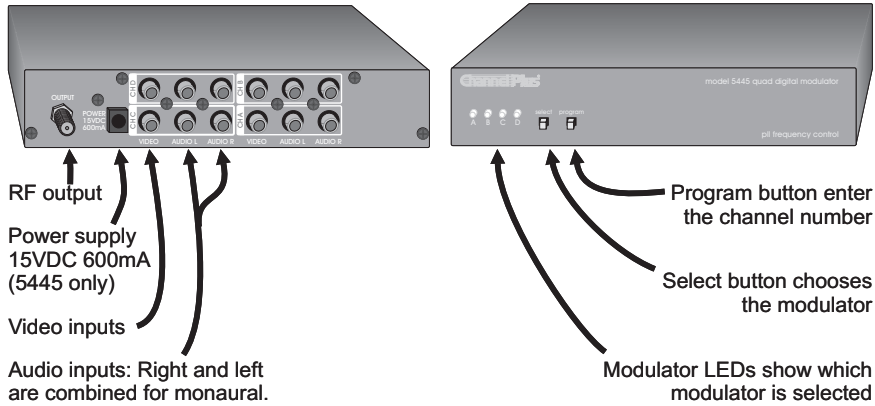

## Model 5435 - three agile modulators

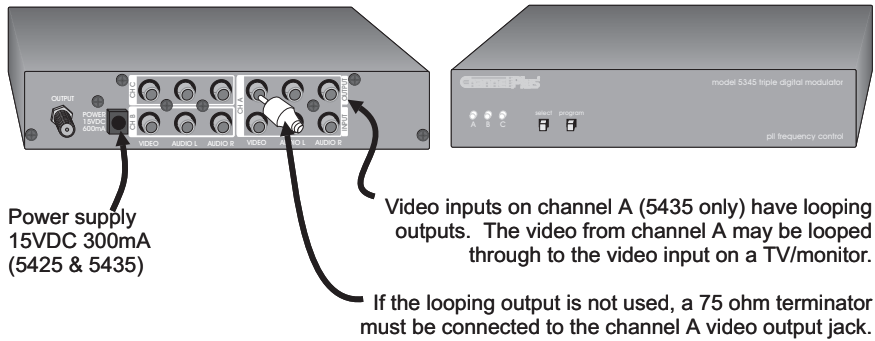

## Model 5425 - two agile modulators



# Sample System Diagram

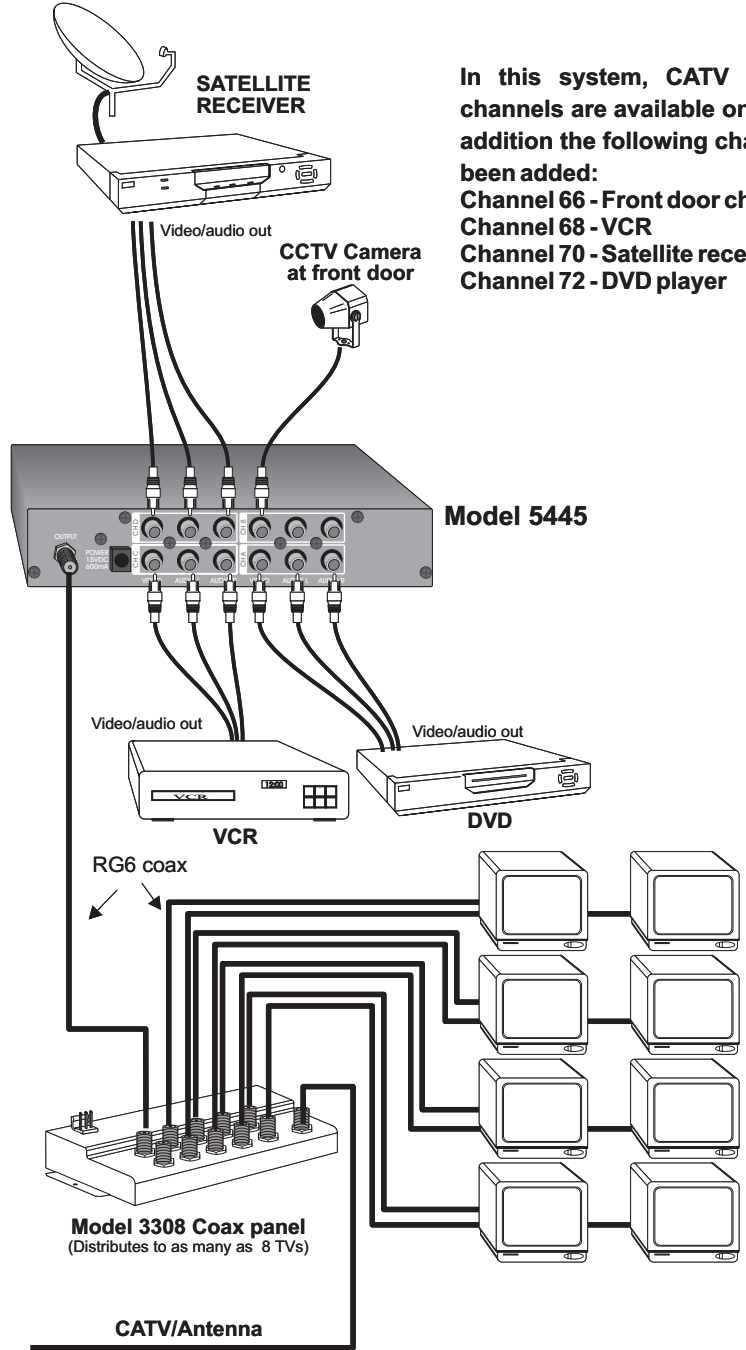

In this system, CATV or antenna channels are available on all TVs. In addition the following channels have been added:  
 Channel 66 - Front door channel  
 Channel 68 - VCR  
 Channel 70 - Satellite receiver  
 Channel 72 - DVD player

## Programming Examples:

To program modulator **B** to channel **67**

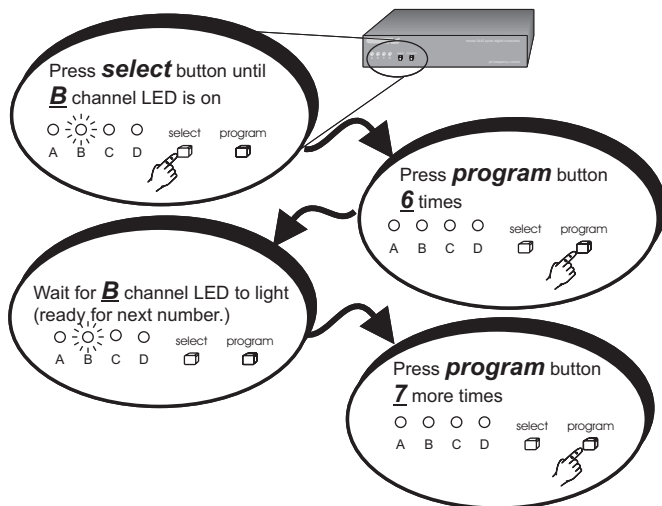

To program modulator **C** to channel **120**

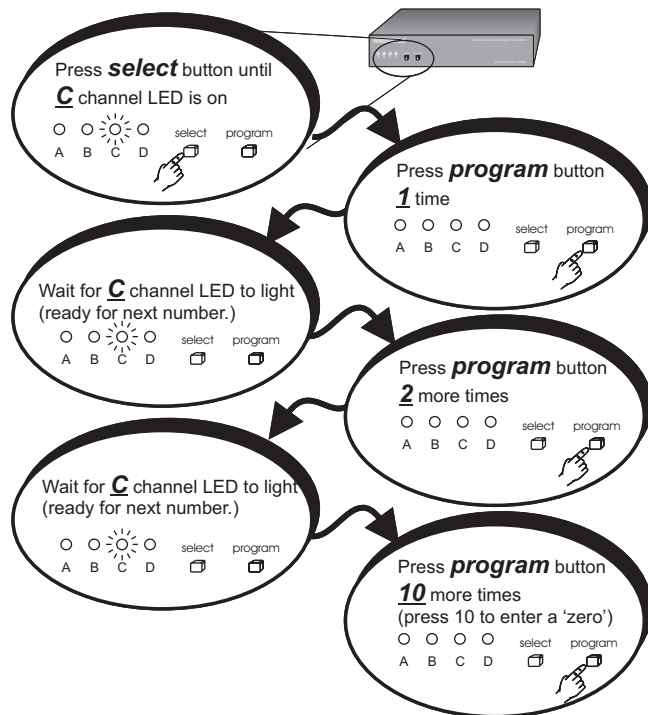

**Valid Channels:**  
 14-64: UHF channels  
 65-125: CATV channels  
 95-99: not valid

**Channel Spacing:** Skip at least one number between channels.  
 Channels 14 and 16: OK.  
 Channels 14 and 15: Illegal.

**Error indication:** If an error has occurred or an incorrect channel is entered, the LED will flash quickly for a second and return to the previous settings.

If two adjacent channels are selected, the unit will accept the entry but will blink the LEDs of channels that are too close. If this happens, re-program one of the channels to move it away from the other.

**Channel number readback:** A readback mode will display the current channel assignments.

To readback modulator **C** channel assignment (example: C has been programmed to channel **108**)

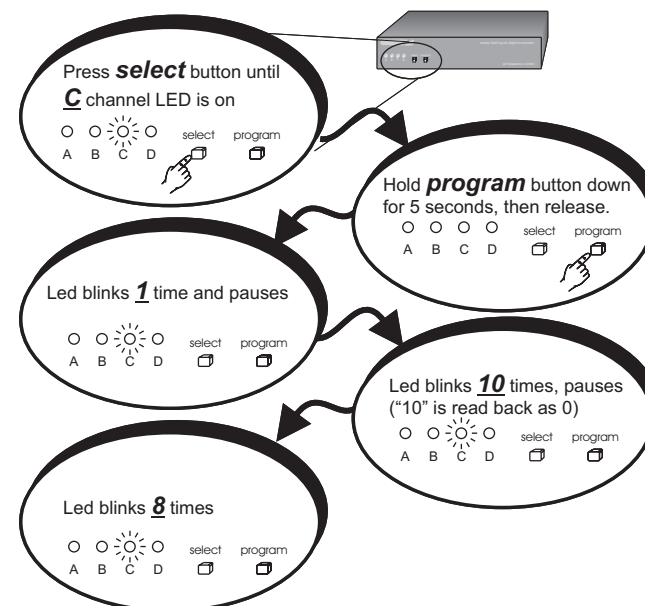

## Things to watch for:

**No picture ...** Verify that the video source is on and is producing a video signal. Check that the TV and the modulator are tuned to the same channel. For example, if the modulator is broadcasting on UHF channel 16, make sure the TV is on UHF 16 rather than CATV 16. UHF 16 and CATV 16 are at different frequencies.

**Weak ChannelPlus UHF channel ...** If the TV has a separate UHF input, be sure that it is connected.

**LEDs blink ...** You need to have one unused channel space between channels. The display will blink if you have made an 'illegal' choice. See the section on programming.

**Herringbone interference on ChannelPlus channel (diagonal lines) ...** You may have chosen a channel number that is not completely vacant. Distant UHF stations may be un-watchable, but will cause interference if you try to create a new channel at the same frequency. Also, cable companies often have extra signals where there should be none. Try moving the ChannelPlus channel to another number. You may have to add a low pass filter to remove cable company noise.

**Herringbone interference on many channels (disappears when you remove the modulator) ...** The high output of the ChannelPlus modulator can overdrive many RF amplifiers. Reduce the RF output using an attenuator. (ChannelPlus coax panels are designed to take the full output of these modulators.)

**Audio volume is low ...** The left and right audio inputs are combined for monaural. For proper audio level, both right and left inputs must be used. If you have a mono source, connect it to both right and left inputs using an RCA 'Y' connector.

**No color on ChannelPlus channels ...** You may have chosen the incorrect cable standard. Not all televisions can accommodate the 1.25MHz frequency difference between the H and I cable standards. See the section on programming.

## Changing modulation standards

### Cable HRC and IRC considerations

Most cable services use IRC frequency assignments. This is the default for the ChannelPlus 5400 series modulators. However, if the cable service uses HRC or the TV appears to search for the "house channels," the modulator can be reprogrammed to use HRC assignments by entering the number "98". Set to IRC by entering a "99". Both of these settings are only used for setting HRC/IRC. **Note:** This setting can be entered on any modulator channel, A, B, C, or D, and affects all channel assignments for that unit. Cable channels must either be all IRC or all HRC.

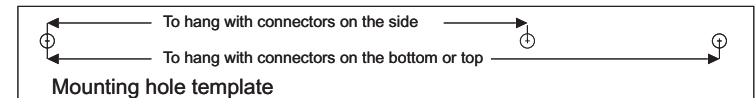

## Specifications: typical @ 25°C ± 5°C

### 5400 Series modulators

<b>Inputs</b>	video	1 Vp-p @ 75Ω		
	audio	1 V rms @ 47kΩ		
		L & R inputs combined for monaural		
<b>Video performance</b>	differential gain	4%		
	differential phase	<4°		
	signal/noise	55 dB		
<b>RF output</b>	standard	UHF	CATV	
	channel ranges	14-64	65-125 (excluding 95-99)	
	output level	+25 dBmV (90dBuV)		
	IM distortion	-60 dBC		
	alternate channel	-45dBC @ 12MHz		
<b>Power supply</b>	model number	5425	5435	5445
	output current	300mA	300mA	600mA
	output voltage	15 VDC		
	input power	105-125 VAC		
	power consumption	3.5 watts	5 watts	7 watts
<b>Physical</b>	height	3.8 cm (1.5 in)		
	width	20.0 cm (7.9 in)		
	depth	14.1 cm (5.5 in)		
	weight	1.19 kg (2 lbs 10 oz)		

## **Warranty**

Multiplex Technology, Inc. warrants this products to be free from defects in materials and workmanship for a period of one year from the date of purchase or MTI will repair, or at its option, replace the defective product. To obtain warranty service, call MTI for a return material authorization (RMA) number and return the product prepaid to Multiplex Technology, Inc., 3001 Enterprise Street, Brea, CA 92821, Attention: Customer Service. Please put the RMA number on the outside of the carton.

Any implied warranty arising from the sale of the product including implied warranties of merchantability and fitness for purpose are limited to the warranty stated above. MTI shall not be responsible for losses or damages or expenses, whether direct, consequential or incidental arising from the use of or the inability to use this product. Some states do not allow limitations on how long the implied warranty lasts or the exclusion or limitation or incidental or consequential damages, so the above limitations and exclusions may not apply to you. This warranty gives you specific legal rights, and you may have other rights which may vary from state to state.