C-100-A1 Manual

Version 2.0



Northern Computers, Inc.

5007 South Howell Avenue
Milwaukee, Wisconsin 53207
Telephone: (414) 769-5989
Fax: (414) 769-5989

Notices

FIRE SAFETY NOTICE: Never connect any card reader devices or locks to doors, gates or barriers without first consulting the local fire codes. You must consult with and get approval of, local fire officials before installing locks or devices on any doors that may be fire exits. Use of egress push buttons may not be legal. Single action exit may be required. Always obtain proper permits and approvals in writing before installing equipment.

NOTICE: This equipment complies with the limits for class A computing devices in accordance with the specifications in Subpart S of Part 15 of FCC Rules which are designed to minimize radio frequency interference in a residential installation. There is no guarantee that radio or television interference will not occur by activating this equipment.

NOTICE: The information in this document is subject to change without notice.

NOTICE: This document and the data herein shall not be duplicated, used or disclosed to others for procurement or manufacturing, except as authorized with the written permission of Northern Computers, Inc. The information contained within this document or within the product itself is considered the exclusive property and trade secrets of Northern Computers, Inc. All information in this document or within the software product itself is protected by the copyright laws of the United States.

NOTICE: Any use of this product is subject to the terms and acceptance of the Northern Computers, Inc. "Software Agreement." Please request a copy from Northern Computers, Inc. and review this agreement carefully.

Table Of Contents

Function	4
Specifications	4
C-100-A1 computer connection	7
C-100-A1 terminal connection	8
C-100-A1 modem connection	9
Power	9
Verify Communication	10
To verify C-100-A1 operation	10
To verify serial data port operation	11
LEDs	11

Function

The C-100-A1 Converter serves as the interface between the programming device (computer, printer/programmer or data terminal) and the N-1000 series control panels. The C-100-A1 allows the programming device, using RS-232 protocol, to communicate with the control panels in a 20 mA current loop.

Specifications

C-100-A1 size specifications are as follows:

Height: 1.75 inches (4.445 cm)

Width: 5.125 inches (13.018 cm)

Depth: 3.5 inches (8.89 cm)

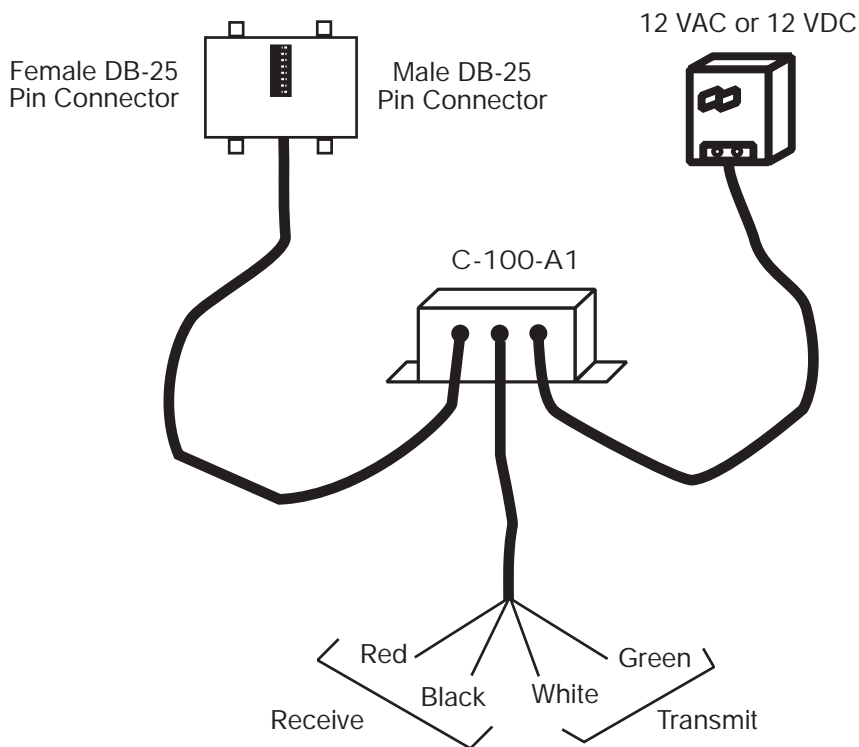
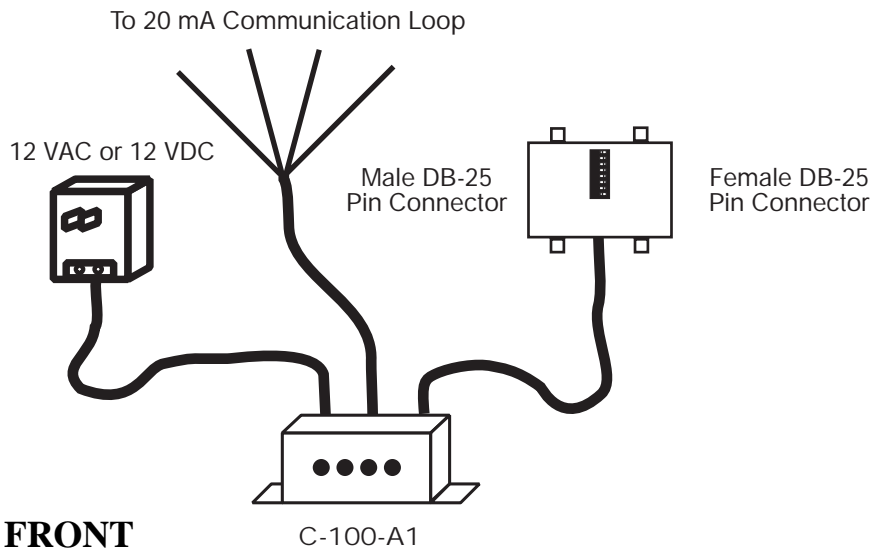



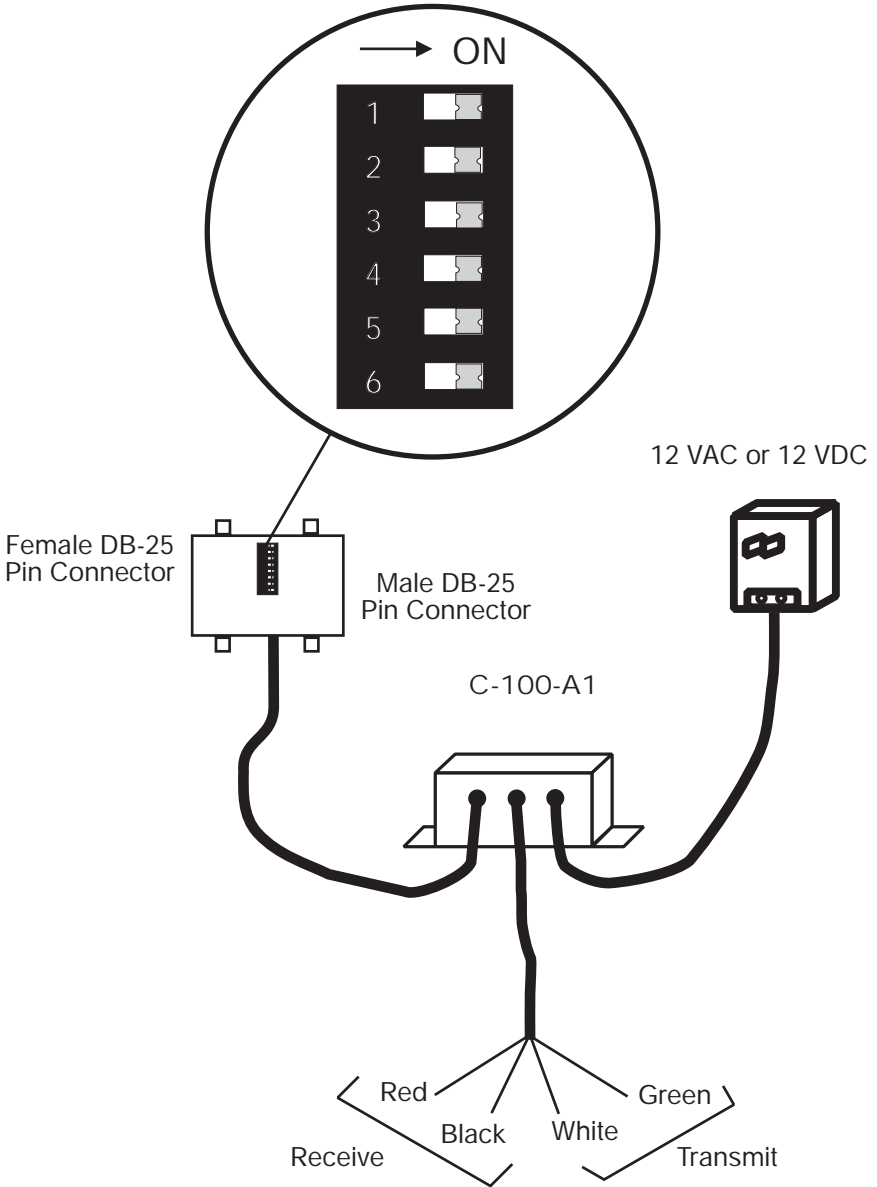



The C-100-A1 can be configured for use with a computer, terminal or modem connection, depending on the position of six DIP switches on the connector shown below:



For connection from a computer to local control panels, configure the Converter for a computer connection. For connection from an S-3000 printer/programmer to local control panels, configure the Converter for a terminal connection. For connection to remote control panels, via modems, configure the Converter for a modem connection.

The DIP switch settings for the three C-100 types are shown below:

C-100-A1 computer connection







<u>Switch</u>	<u>Position</u>	→ ON
1	On	
2	On	
3	Off	
4	On	
5	On	
6	Off	

The C-100-A1 computer DIP switch settings shown above correspond to the following pinouts:

<u>Pin</u>	<u>C-100-A1 computer connection</u>
2	Receive
3	Transmit
7	Signal Ground

If using the Male side of the C-100-A1 computer connection, reverse all dip switch settings.







C-100-A1 terminal connection

<u>Switch</u>	<u>Position</u>	→ ON
1	Off	
2	On	
3	On	
4	Off	
5	Off	
6	On	

The C-100-A1 terminal DIP switch settings shown above correspond to the following pinouts:

<u>Pin</u>	<u>C-100-A1 terminal connection</u>
2	Receive
3	Transmit
6	Data Set Ready
7	Signal Ground
8	Received Signal Detection
20	Data Terminal Ready

C-100-A1 modem connection

<u>Switch</u>	<u>Position</u>	→ ON
1	Off	
2	Off	
3	Off	
4	On	
5	On	
6	Off	

The C-100-A1 modem DIP switch settings shown above correspond to the following pinouts:

<u>Pin</u>	<u>C-100-A1 modem connection</u>
2	Transmit
3	Receive
7	Signal Ground

Power

The C-100-A1 requires a 12 VAC (20 VA) or 12 VDC (300 mA) power supply.

Verify Communication

To verify C-100-A1 operation

Step 1: Set the DIP switches to configure the Converter for a computer to local control panels, printer/programmer to local control panels, or modem connection to remote control panels, determined by the programming device in use.

Step 2: Connect the red (receive +) and white (transmit +) wires together.

Connect the black (receive -) and green (transmit -) wires together.

Step 3a: For WIN-PAK: With a Windows based computer, enter terminal/hyper terminal mode (WIN-PAK must be closed and flow control must be set to None) and type text characters. The text characters should appear on the screen immediately as they are typed to verify C-100-A1 operation. (Use this procedure when using S-3000 or data terminal as well.)







Step 3b: For PC-PAK: With a computer running PC-PAK, enter terminal/hyper terminal mode and type text characters. The text characters should drop down from the command line to the display section of the monitor when the ENTER key is pressed, to verify C-100-A1 operation. (Use this procedure when using S-3000 or data terminal as well.)

If C-100-A1 verification fails, then verify serial data port operation of the programming device.

To verify serial data port operation

Step 1: Set the DIP switches as shown below:

Com Port Loop Back Test:

<u>Switch</u>	<u>Position</u>	→ ON
1	On	
2	On	
3	Off	
4	Off	
5	On	
6	On	

Step 2: Short pins 2 and 3 of the programming device together and follow the steps for verifying communication with the C-100-A1.

LEDs

C-100-A1 LEDs are numbered as shown below:

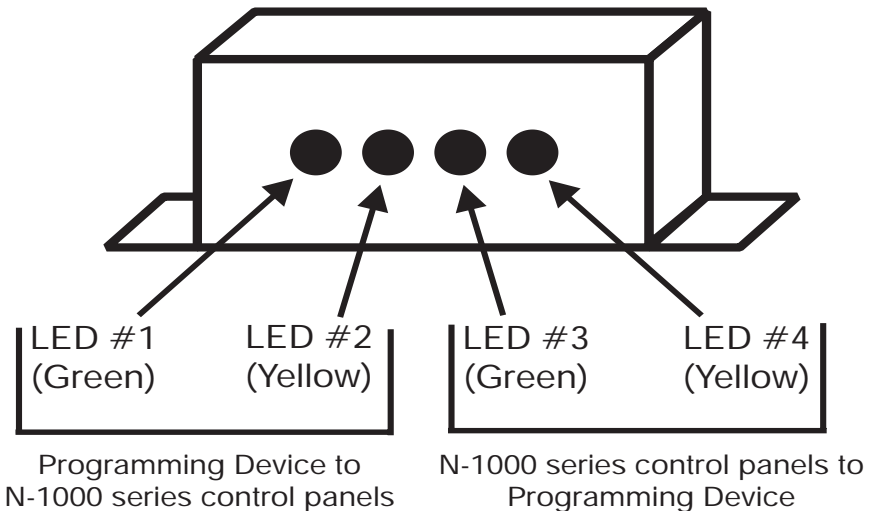

The following chart serves as a troubleshooting guide, showing LED status for various situations:

Power	DB-25 Connected	Red/Black Connected	White/Green Connected	LEDs Lit
On	No	No	No	#2
On	No	No	Yes	#2, 3, 4
On	No	Yes	No	#1, 2
Off	No	Yes	Yes	#3
On	Yes	No	No	#2

DB-25 is connected to a programming device. Red/Black and White/Green are connected to control panel(s).

LED #1 not lit indicates a problem with the 20 mA current loop, from the C-100-A1 to the N-1000 series control panels, such as an open loop (miswire).

LED #2 not lit indicates an RS-232 data problem, from the programming device to the C-100-A1. Verify DIP switch settings, verify that the proper end (male/female) of the Connector is used and check for shorts.

LED #3 not lit indicates a problem with the 20 mA current loop, from the N-1000 series control panels to the C-100-A1, such as an open loop (miswire).

LED #4 not lit indicates a problem with the 20 mA current loop, from the N-1000 series control panels to the C-100-A1 and/or an RS-232 data problem, from the C-100-A1 to the programming device. Check for a miswire or damaged C-100-A1.



Leaders in Access Control Technology

5007 South Howell Avenue
Milwaukee, WI 53207
Telephone: (414) 769-5980
Fax: (414) 769-5989

www.nciaccess.com